



MANUFACTURED BY:  
Backyard Discovery  
3305 Airport Drive, Pittsburg, KS 66762  
800-856-4445

Backyard Discovery Australia Pty Ltd 2/7 Hood Street, Hampton VIC 3188, Phone: 1800-087-941

# CARAWAY COTTAGE - LT.BRN PLAYHOUSE

## Model # 2503045

The assembly manual must be retained  
since it contains important information



**WARNING**  
*Adult Assembly Required.*  
**FOR DOMESTIC USE ONLY. INTENDED FOR OUTDOOR USE.**

CAN ICES-003 (B)/NMB-003(B)



**Please visit [www.backyarddiscovery.com](http://www.backyarddiscovery.com)**

For the most up to date assembly manual, to register your set, or to order replacement parts  
*Para obtener instrucciones en español, visite [www.backyarddiscovery.com](http://www.backyarddiscovery.com)*

# Owner's Manual - Basic Setup Dimensions & Assembly Notes

Selecting the correct location for your play product is important for your children's safety and the product's longevity

- The safe play area refers to a zone extending 6'-7" (2007 mm) beyond the play product on all sides, including the space above the play product.

## SAFE PLAY AREA DIAGRAM

### Ground Dimension

3'-7 1/4" [1096 mm] x 4'-2 1/4" [1276 mm]

### Safe Play Area

16'-9 1/4" [5110 mm] x 17'-4 1/4" [5290 mm] x 11'-4" [3454 mm]

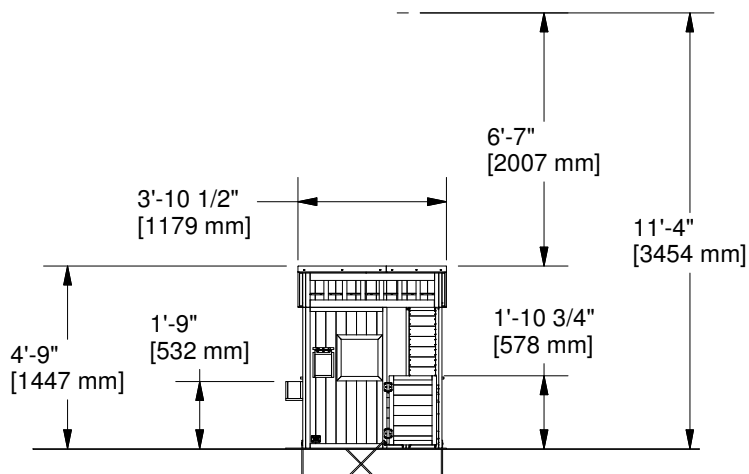
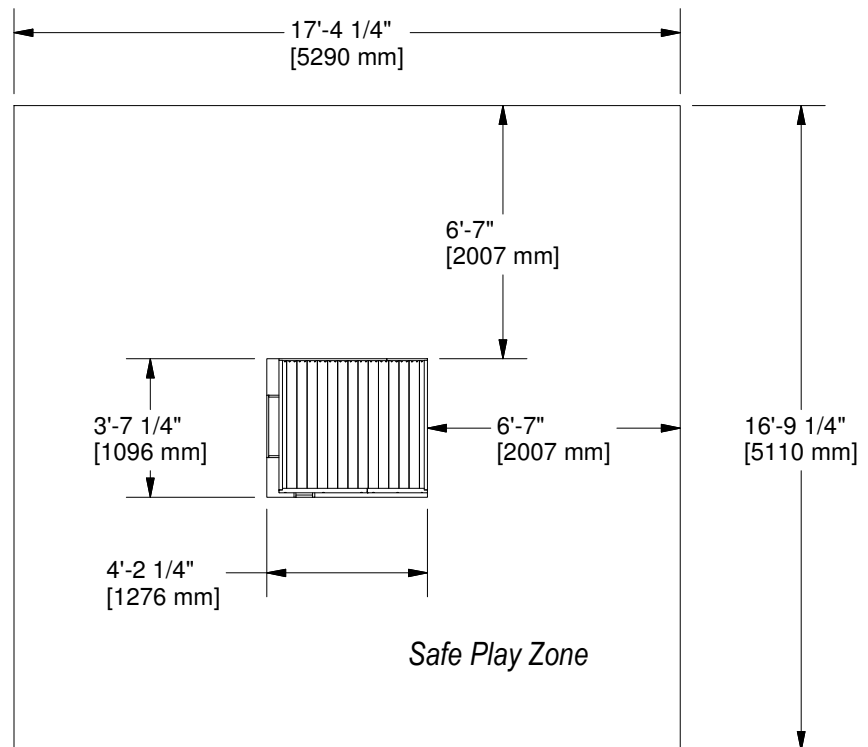

SAFE PLAY HEIGHT: 11'-4" [3454m]  
MAXIMUM FALL HEIGHT: 1'-10 3/4" [578 mm]

### General Information:

Your set has been designed and engineered for children only and for residential use only.  
A maximum of 150 lbs. per child is recommended for play activities designed for individual use.  
A maximum of 120 lbs. per child is recommended for play activities designed for multiple child use.  
A maximum of 6 children is recommended for this playhouse.

# Owner's Manual - Parts Identification

## Wood Components (Not to Scale)

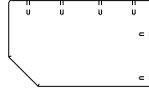

**AD01 TABLE TOP SUPPORT - W4L19818**

(x1) 1"x4"x6 3/4" (24x102x172)



**F01 ROOF TRIM - W4L19315**

(x2) 1"x1 7/8"x41 7/8" (26x47x1064)

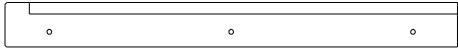

**F03 ROOF TRIM - W4L19820**

(x1) 1"x1 7/8"x18 7/8" (26x47x479)

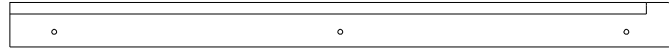

**F02 ROOF TRIM - W4L19316**

(x1) 1"x1 7/8"x27 1/2" (26x47x700)

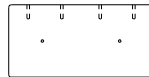

**H01 TABLE TOP SUPPORT - W4L19817**

(x2) 1"x3 3/8"x6 3/4" (24x86x172)



**J01 TOP RAIL - W4L19821**

(x1) 1"x1 3/8"x41 5/8" (24x34x1057)

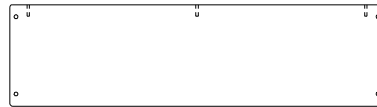

**K01 FRONT - W4L19822**

(x1) 5/8"x5 1/4"x19 1/2" (16x134x495)

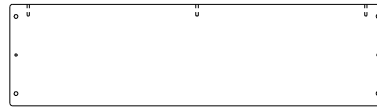

**K02 BACK - W4L19823**

(x1) 5/8"x5 1/4"x19 1/2" (16x134x495)



**K03 BOTTOM - W4L19825**

(x1) 5/8"x5 1/4"x19 1/2" (16x134x495)

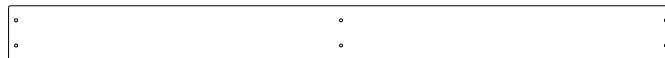

**M02 TABLE TOP - W4L19816**

(x2) 5/8"x3 3/8"x41 5/8" (16x86x1056)

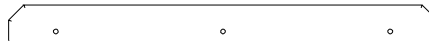

**N01 WINDOW BOARD - W4L19309**

(x2) 5/8"x1 5/8"x17 7/8" (16x40x454)

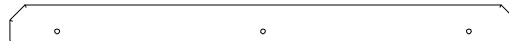

**N02 WINDOW BOARD - W4L19310**

(x1) 5/8"x1 5/8"x21 1/8" (16x40x536)



**N04 ROOF TRIM - W4L19819**

(x1) 5/8"x1 3/8"x12 3/4" (16x34x324)



**N03 ROOF TRIM - W4L19317**

(x1) 5/8"x1 3/8"x33 5/8" (16x34x855)

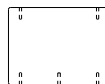

**Y01 SIDE - W4L19824**

(x2) 5/8"x4"x5 1/4" (16x102x134)

# Owner's Manual - Parts Identification

## Wood Components (Not to Scale)

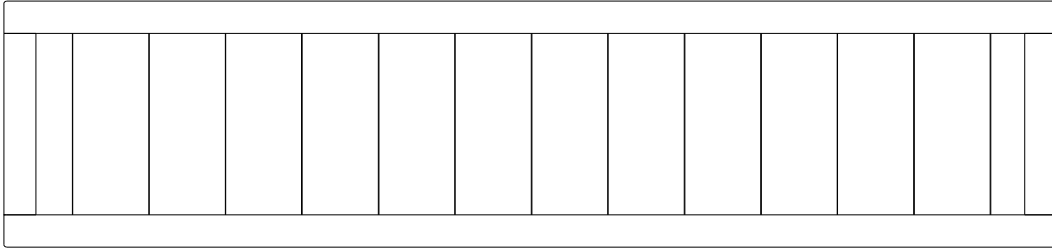

**WP01 WALL PANEL - W2A04140**  
(x1) 1"x10 1/4"x43 7/8" (24x260x1115)

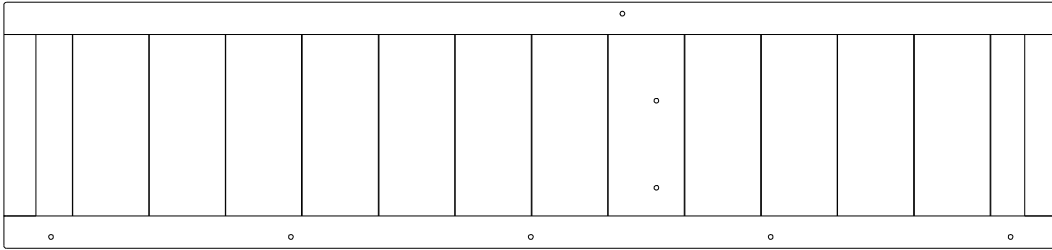

**WP02 WALL PANEL - W2A04141**  
(x1) 1"x10 1/4"x43 7/8" (24x260x1115)

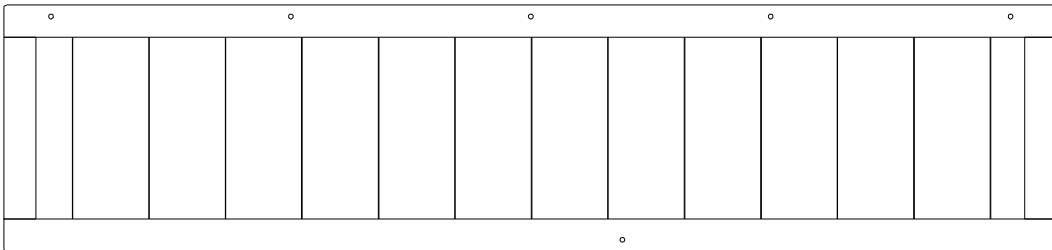

**WP03 WALL PANEL - W2A04142**  
(x1) 1"x10 1/4"x43 7/8" (24x260x1115)

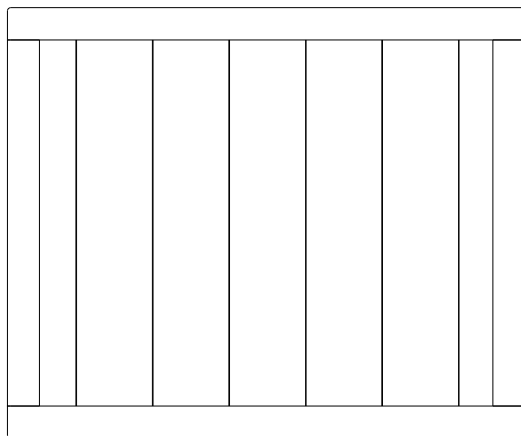

**WP04 WALL PANEL - W2A04143**  
(x2) 1"x10 1/4"x43 7/8" (24x455x548)

# Owner's Manual - Parts Identification

## Wood Components (Not to Scale)

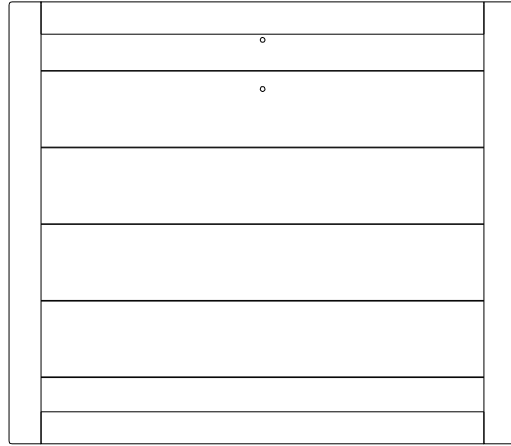

**WP05 WALL PANEL - W2A04144**  
(x1) 1"x18 3/8"x21 1/8" (24x467x537)

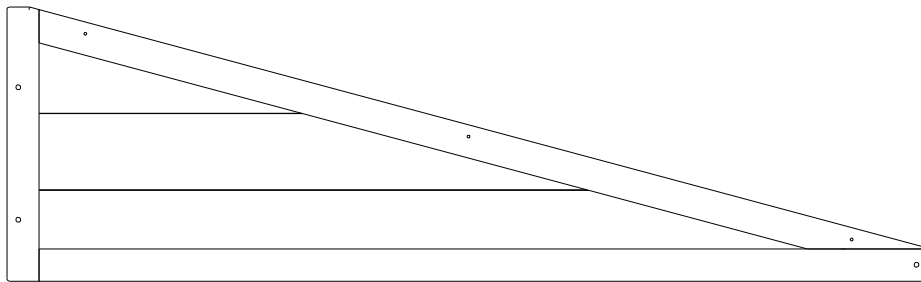

**WP06 WALL PANEL - W2A04145**  
(x1) 1"x11 3/8"x38 3/8" (24x290x975)

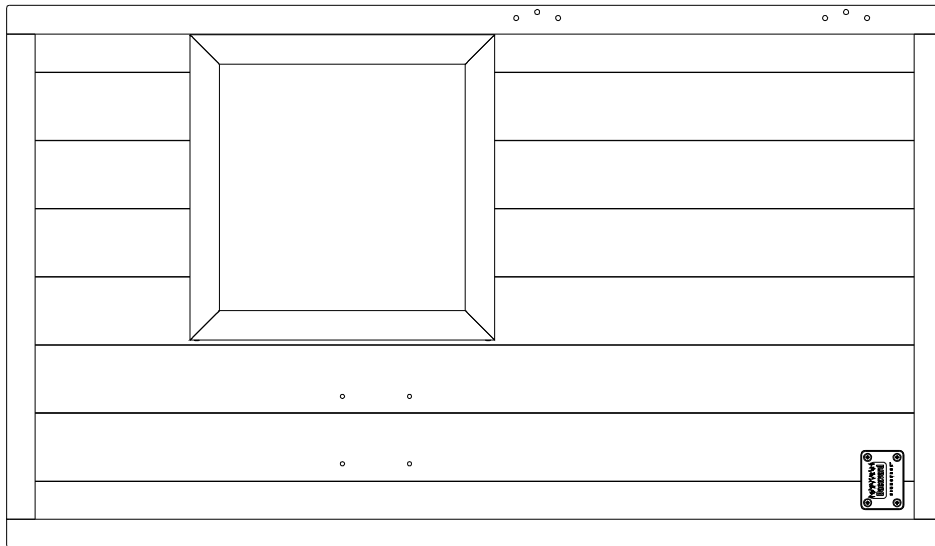

**WP07 WALL PANEL - W2A04146**  
(x1) 1"x10 1/4"x43 7/8" (24x645x1115)

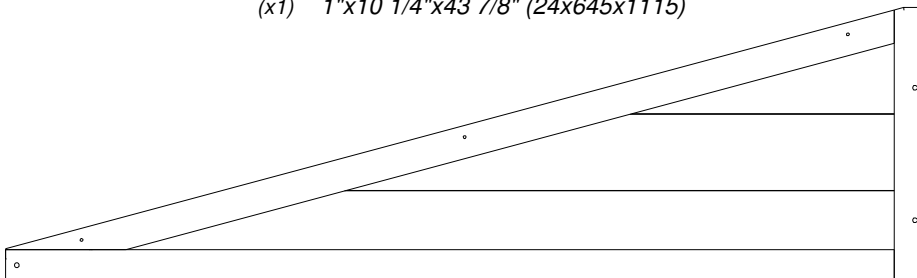

**WP08 WALL PANEL - W2A04147**  
(x1) 1"x11 3/8"x38 3/8" (24x290x975)

# Owner's Manual - Parts Identification

## Wood Components (Not to Scale)

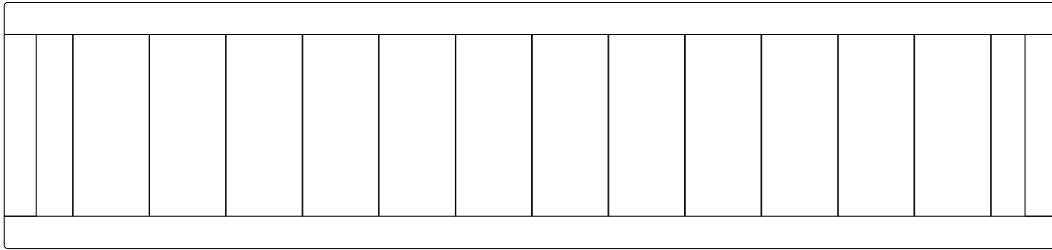

**WP09 WALL PANEL - W2A04149**  
(x1) 1"x10 1/4"x43 7/8" (24x260x1115)

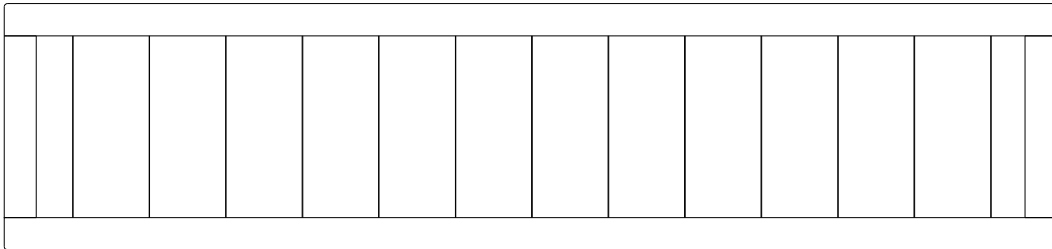

**WP10 WALL PANEL - W2A04221**  
(x1) 1"x10 1/4"x43 7/8" (24x260x1115)

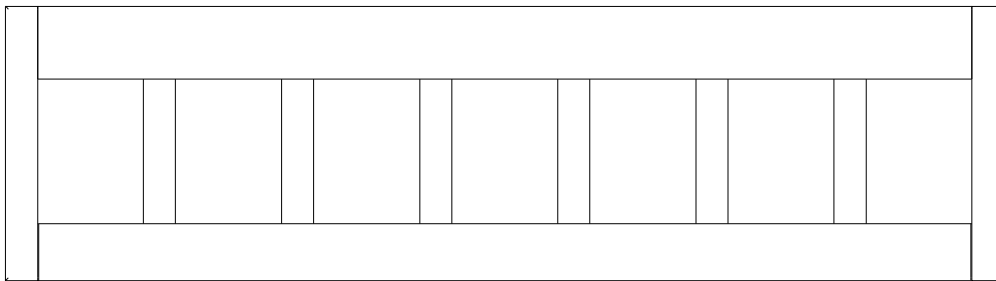

**WP11 WALL PANEL - W2A04222**  
(x1) 15/16"x11 7/16"x41 5/8" (24x290x1057)

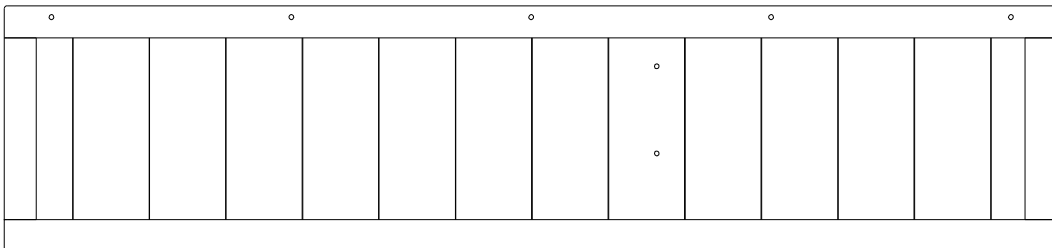

**WP12 WALL PANEL - W2A04224**  
(x1) 1"x10 1/4"x43 7/8" (24x260x1115)

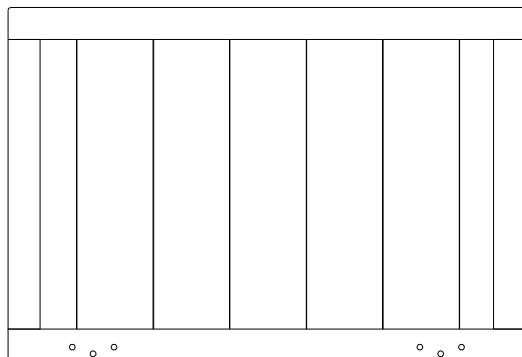

**DP01 DOOR PANEL - W2A04148**  
(x1) 1"x10 1/4"x43 7/8" (24x374x548)

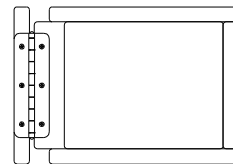

**MB01 MAILBOX - W2A04223**  
(x1) 3 3/8"x6 9/16"x8 3/4" (86x166x222)

# Owner's Manual - Parts Identification

## Wood Components (Not to Scale)

**RP01 ROOF PANEL - W2A04130**  
(x1) 1 3/8"x24 5/8"x41 7/8" (35x625x1064)



**RP02 ROOF PANEL - W2A04131**  
(x1) 1 3/8"x21 1/8"x41 7/8" (35x535x1064)

# Owner's Manual - Parts Identification

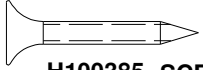
## Hardware Components

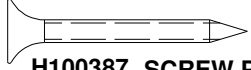

**H100385 SCREW PFH BLK**  
(x4) 8x1



**H100387 SCREW PFH BLK**  
(x25) 8x1 1/4

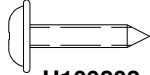

**H100202 SCREW PWH BLK**  
(x2) 8x5/8

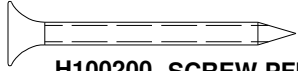

**H100200 SCREW PFH BLK**  
(x39) 8x1 1/2

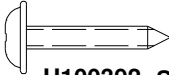

**H100392 SCREW PWH BLK**  
(x71) 8x3/4

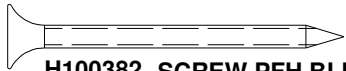

**H100382 SCREW PFH BLK**  
(x6) 8x1 3/4

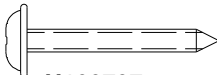

**H100797 SCREW PWH BLK**  
(x4) 8x1

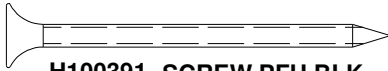

**H100391 SCREW PFH BLK**  
(x23) 8x2

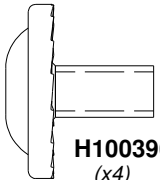

**H100396 BOLT WH BLK**  
(x4) 5/16x1/2

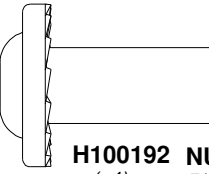

**H100192 NUT BARREL WH BLK**  
(x4) 5/16x7/8

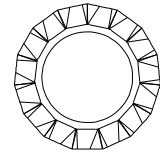

**H100199 WASHER LOCK EXT BLK**  
(x4) 12x19

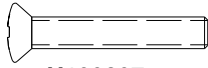

**H100807 SCREW POH BLK**  
(x12) 8/32x1



**H100804 T-NUT**  
(x12) 8/32

# Owner's Manual - Parts Identification

## Accessory Components (Not to Scale)

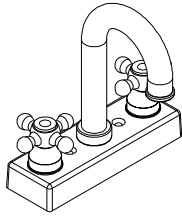

**A6P00024** FAUCET KIT  
(x1)

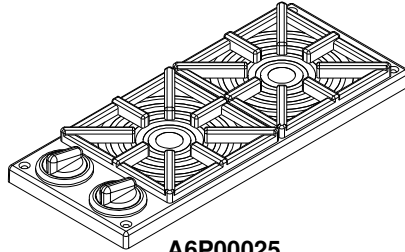

**A6P00025** STOVE KIT  
(x1)

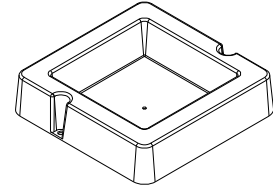

**A6P00032** SURFACE  
MOUNT BASIN  
(x1)



**A6P00336** BOIL POT  
(x1)



**A6P00338** FRY PAN  
(x1)



**A6P00337** POT/PAN LID  
(x1)

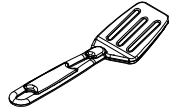

**A6P00339** SPATULA  
(x1)

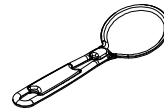

**A6P00340** LADLE  
(x1)

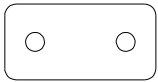

**A4M02752** CLEAT  
(x8)



**A4M00624** HINGE (DOOR,  
SPRING  
LOADED)  
(x1)

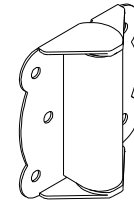

**A4M00994** HINGE (DOOR,  
NON-SPRING  
LOADED)  
(x1)

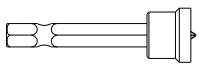

**H100764** SCREW SETTER  
(x1)

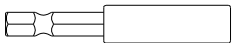

**H101100** MAGNETIC DRIVER  
(x1)

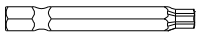

**H100147** T-30 TORX BIT  
(x1)

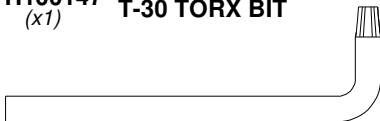

**H100114** T-30 TORX WRENCH  
(x1)

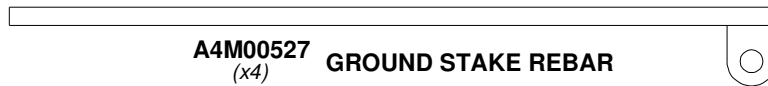

**A4M00527** GROUND STAKE REBAR  
(x4)

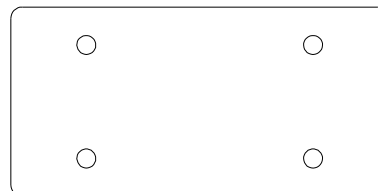

**A4M02100** CLEAT  
(x12)



**A4M02754** METAL TIE STRAP  
(x1)

# PRE-ASSEMBLY STEP 1 - SORTING PARTS

It is critical for ease of assembly that you take the time to sort and organize the wood and hardware.

---

## WOOD PARTS:

- Organize wood parts by the three-digit, alpha-numeric number stamped on each board (ex. P01).
- If there are multiple boards with the same stamped number, stack those pieces together.
- Stamps can be found on the flat surface of the boards or on the end of the boards.
- Allow yourself plenty of room - the wood pieces can take up a significant amount of space.

**NOTE: CARTONS ARE NOT ORGANIZED BY BOARD NUMBER.**

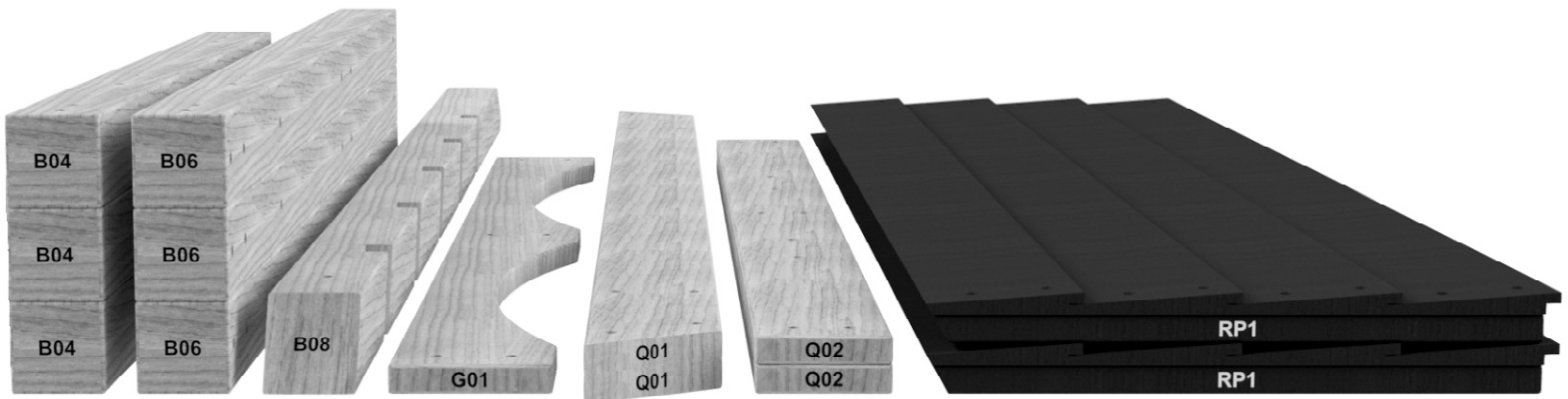

---

## HARDWARE PARTS:

- We recommend that you have a separate table to organize the hardware.
- Hardware bags are printed with a seven-digit, alpha-numeric part number.
- You can organize your hardware by part number or group by hardware type (i.e. bolts, nuts, etc.).
- During assembly you only need to reference the last four digits of the number.



# PRE-ASSEMBLY STEP 2 - TOOLS REQUIRED



Cordless Drill or  
Electric Drill



Drill Attachments:  
Phillips Head



1/8", 3/16", 3/8" & 7/16" Drill Bits



Phillips Screw Driver



Open End Wrenches 1/2" & 9/16"



3/8" Drive Ratchet, 1/2" &  
9/16" STD Sockets 1/2" & 9/16" Deep Sockets



Claw Hammer



Rubber Mallet - Optional

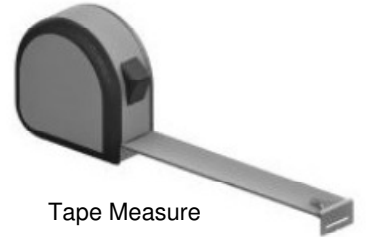

Tape Measure

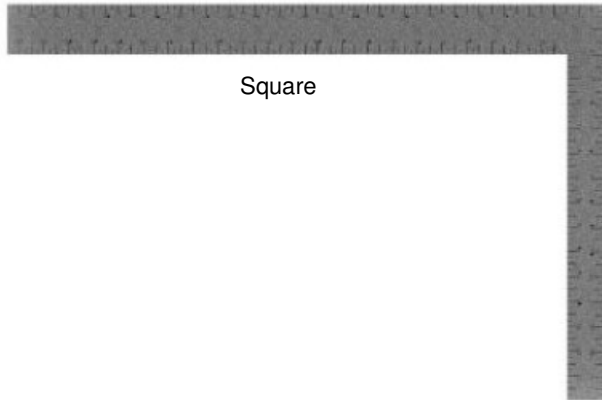

Square



Level 24"

# STEP 1 - BOX ASSEMBLY

QTY	PART NUMBER	DESCRIPTION
4	H100200	SCREW PFH 8x1-1/2 BLK



**K01 FRONT - W4L19822**  
(x1) 5/8"x5 1/4"x19 1/2" (16x134x495)

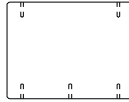

**Y01 SIDE - W4L19824**  
(x2) 5/8"x4"x5 1/4" (16x102x134)

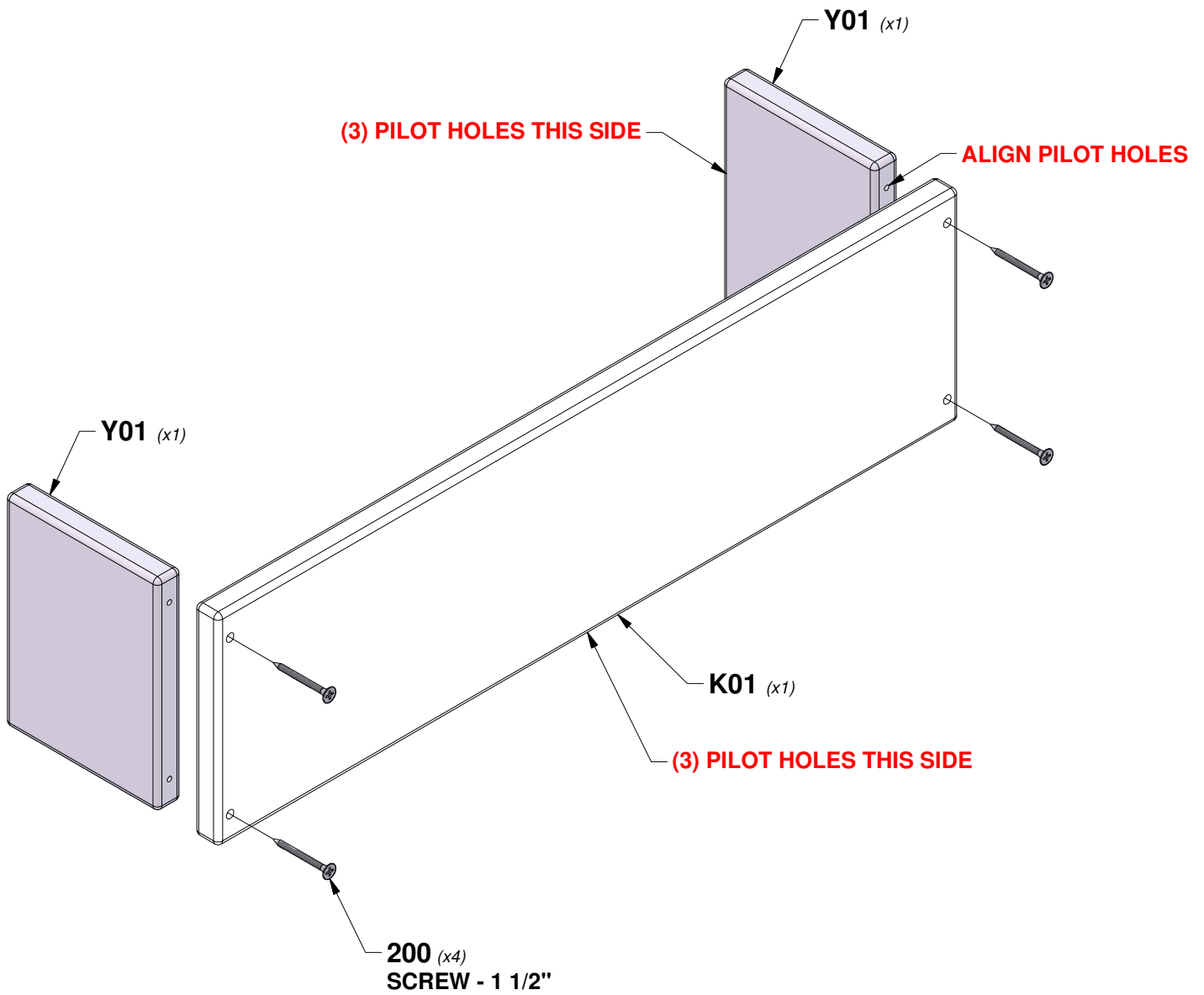

# STEP 2 - BOX ASSEMBLY

QTY	PART NUMBER	DESCRIPTION
4	H100200	SCREW PFH 8x1-1/2 BLK

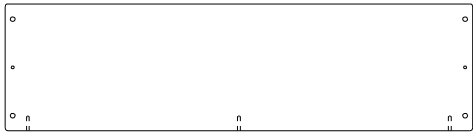

**K02 BACK - W4L19823**  
(x1) 5/8"x5 1/4"x19 1/2" (16x134x495)

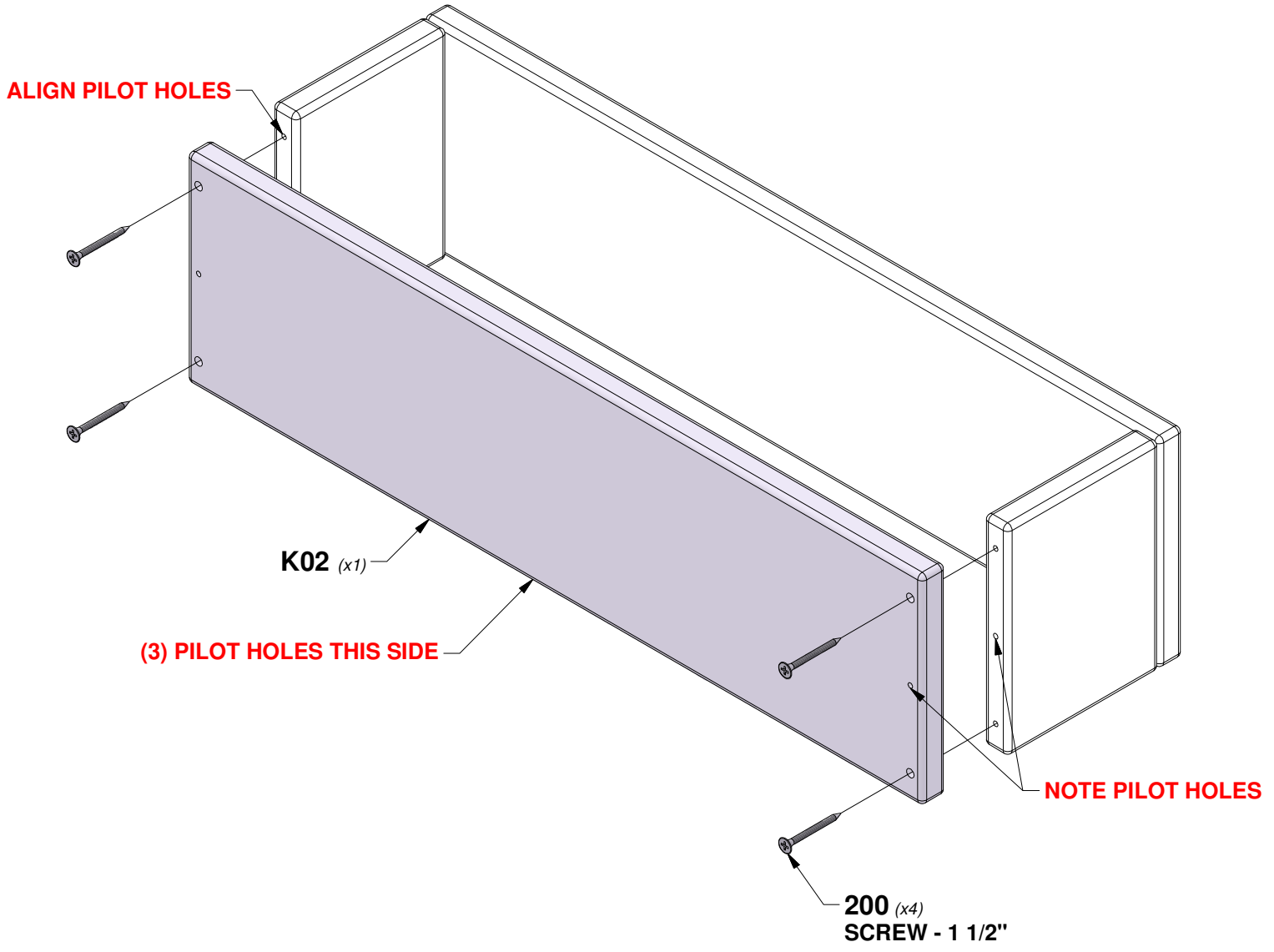

# STEP 3 - BOX ASSEMBLY

QTY	PART NUMBER	DESCRIPTION
6	H100200	SCREW PFH 8x1-1/2 BLK

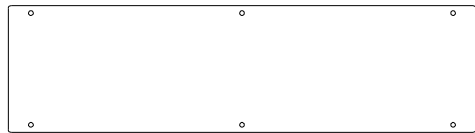

**K03 BOTTOM - W4L19825**  
(x1) 5/8"x5 1/4"x19 1/2" (16x134x495)

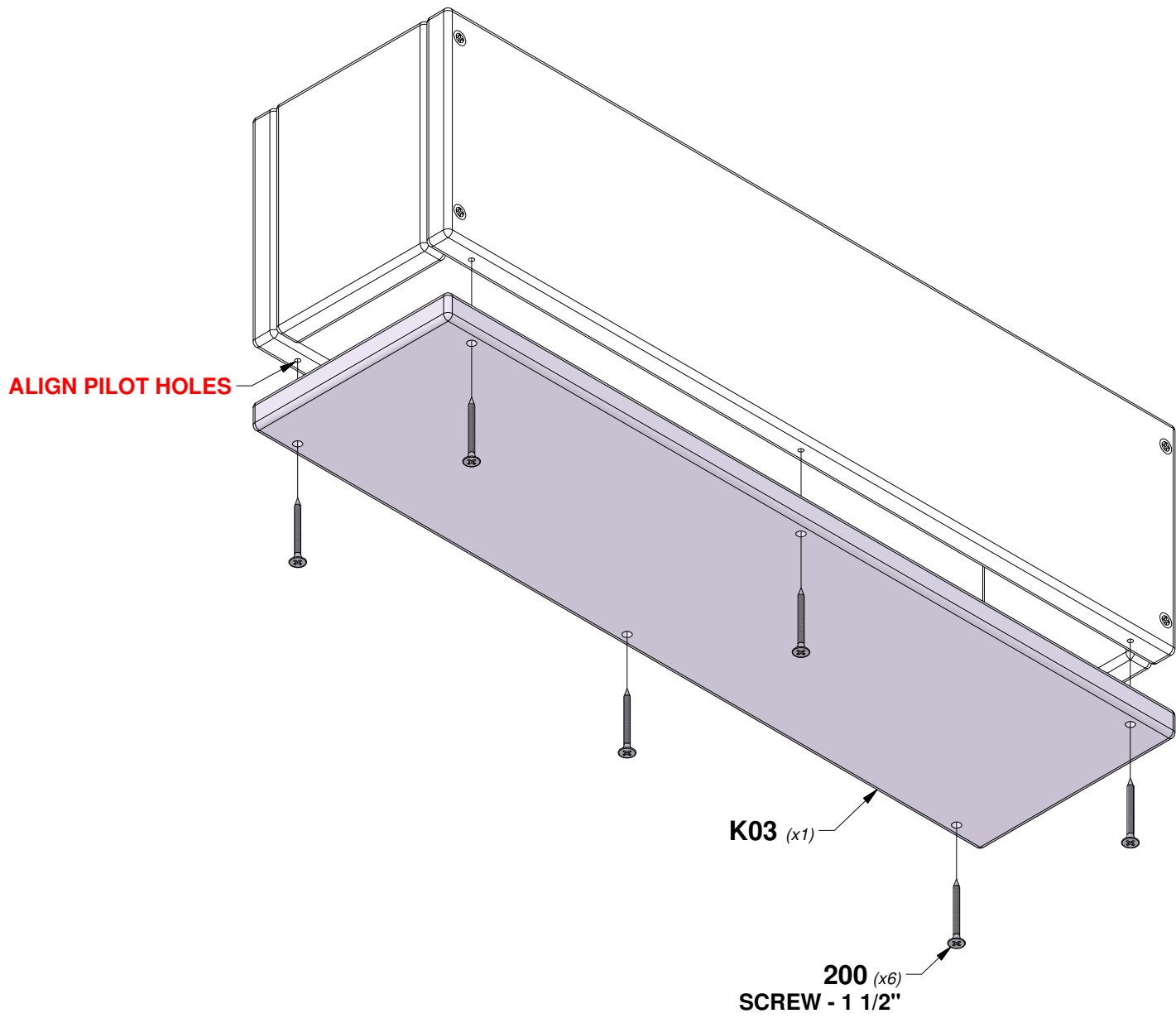

# STEP 1 - PLAYHOUSE ASSEMBLY

QTY	PART NUMBER	DESCRIPTION
5	H100391	SCREW PFH 8x2 BLK

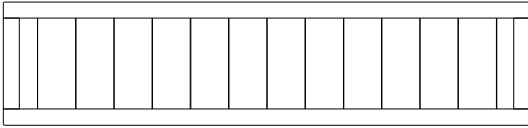

**WP01 WALL PANEL - W2A04140**  
(x1) 1"x10 1/4"x43 7/8" (24x260x1115)

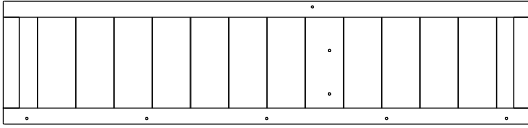

**WP02 WALL PANEL - W2A04141**  
(x1) 1"x10 1/4"x43 7/8" (24x260x1115)

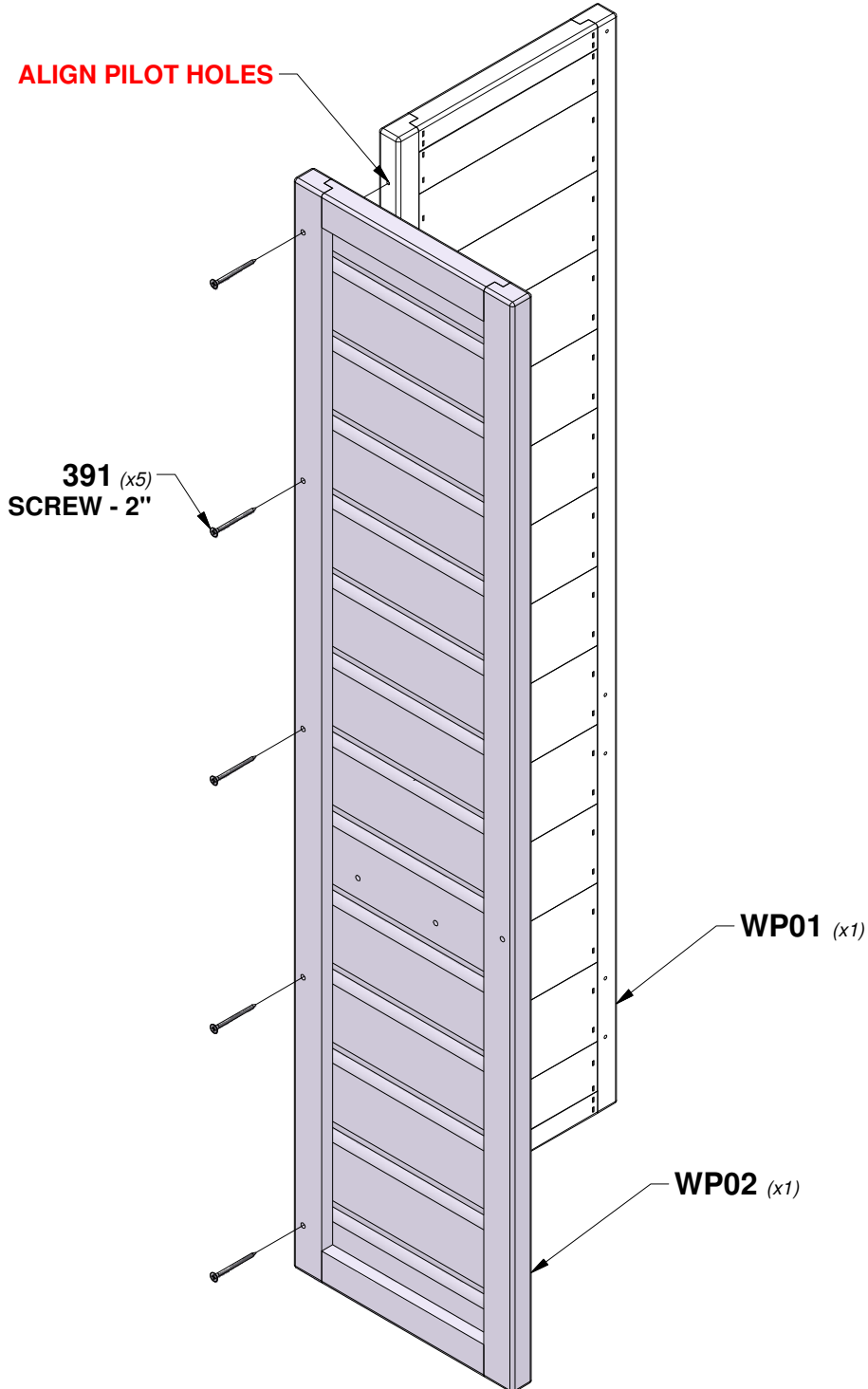

# STEP 2 - PLAYHOUSE ASSEMBLY

QTY	PART NUMBER	DESCRIPTION
8	H100392	SCREW PWH 8x3/4 BLK

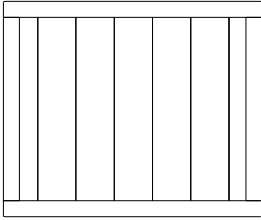

**WP04 WALL PANEL - W2A04143**  
(x1) 1"x10 1/4"x43 7/8" (24x455x548)



**A4M02100 CLEAT**  
(x2)

**TIP:**  
**ALIGN PILOT HOLES**

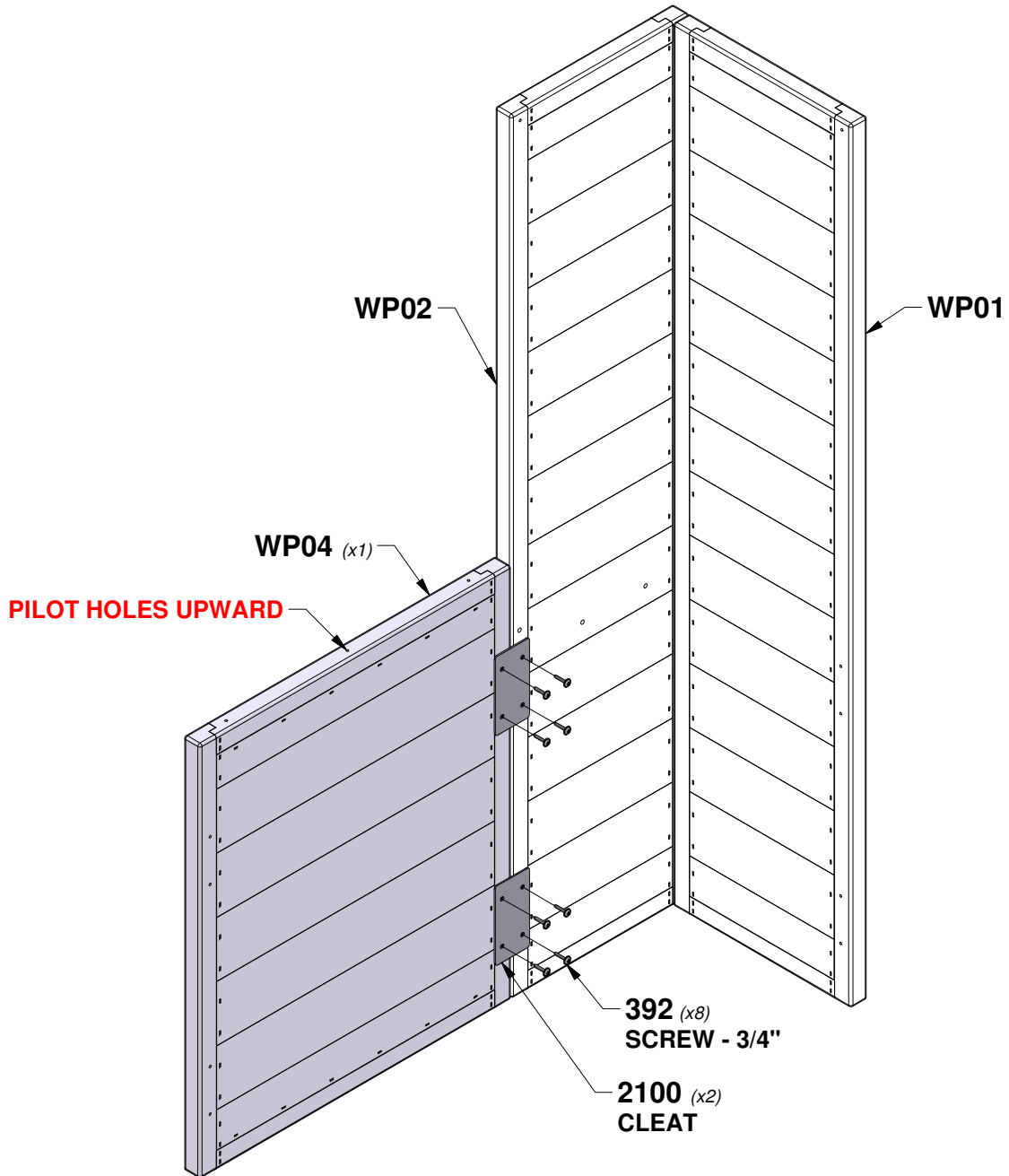

# STEP 3 - PLAYHOUSE ASSEMBLY

QTY	PART NUMBER	DESCRIPTION
8	H100392	SCREW PWH 8x3/4 BLK

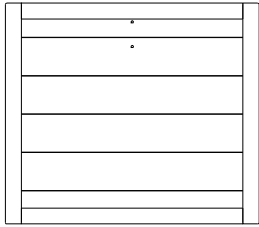

**WP05 WALL PANEL - W2A04144**  
 (x1) 1"x18 3/8"x21 1/8" (24x467x537)



**A4M02100 CLEAT**  
 (x2)

**TIP:**  
**ALIGN PILOT HOLES**

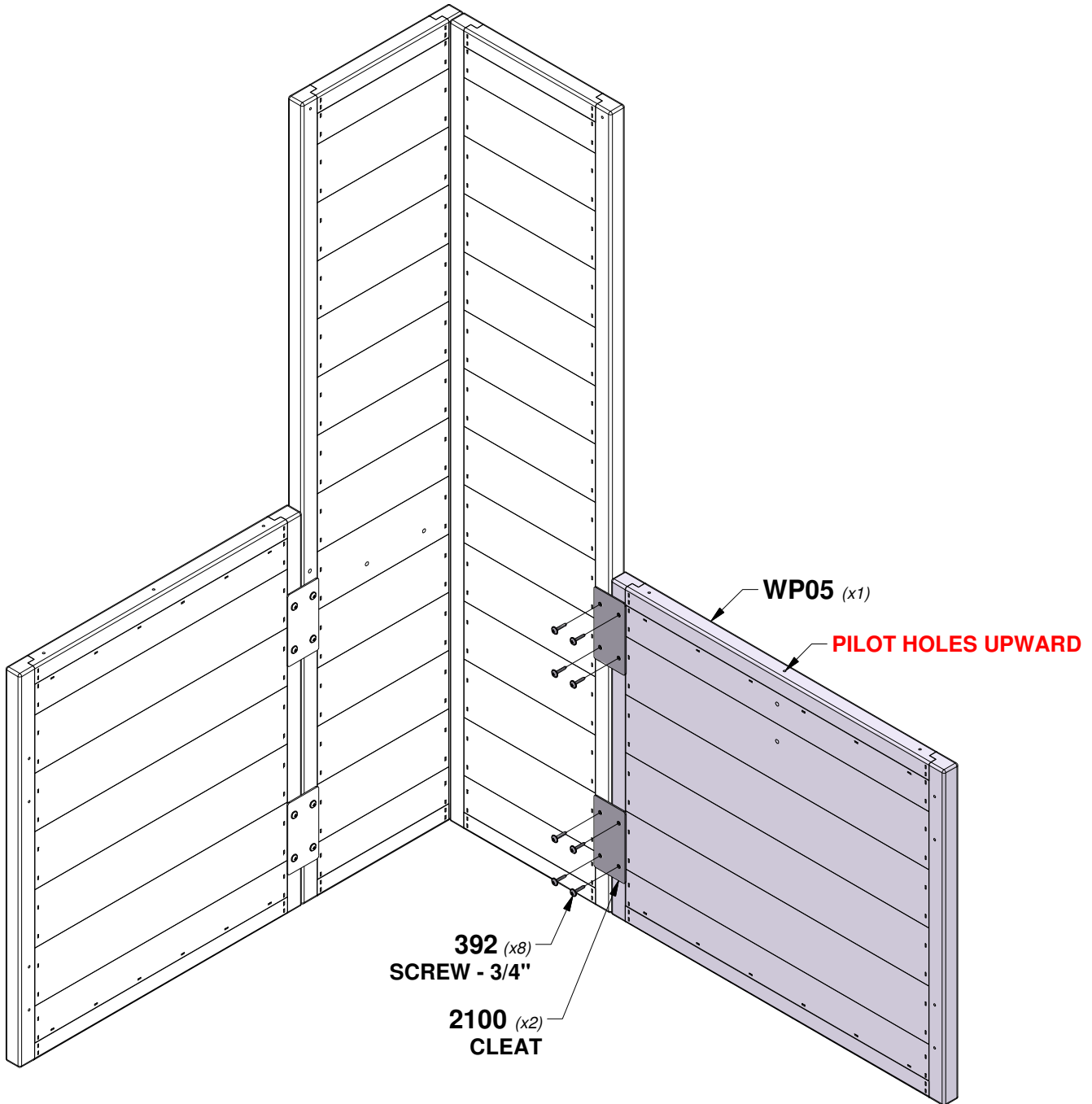

# STEP 4 - PLAYHOUSE ASSEMBLY

QTY	PART NUMBER	DESCRIPTION
8	H100392	SCREW PWH 8x3/4 BLK

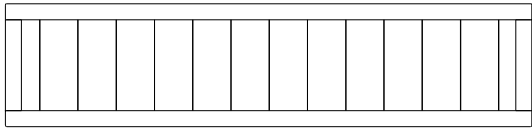

**WP09 WALL PANEL - W2A04149**  
(x1) 1"x10 1/4"x43 7/8" (24x260x1115)

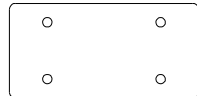

**A4M02100 CLEAT**  
(x2)

**TIP:**  
**ALIGN PILOT HOLES**

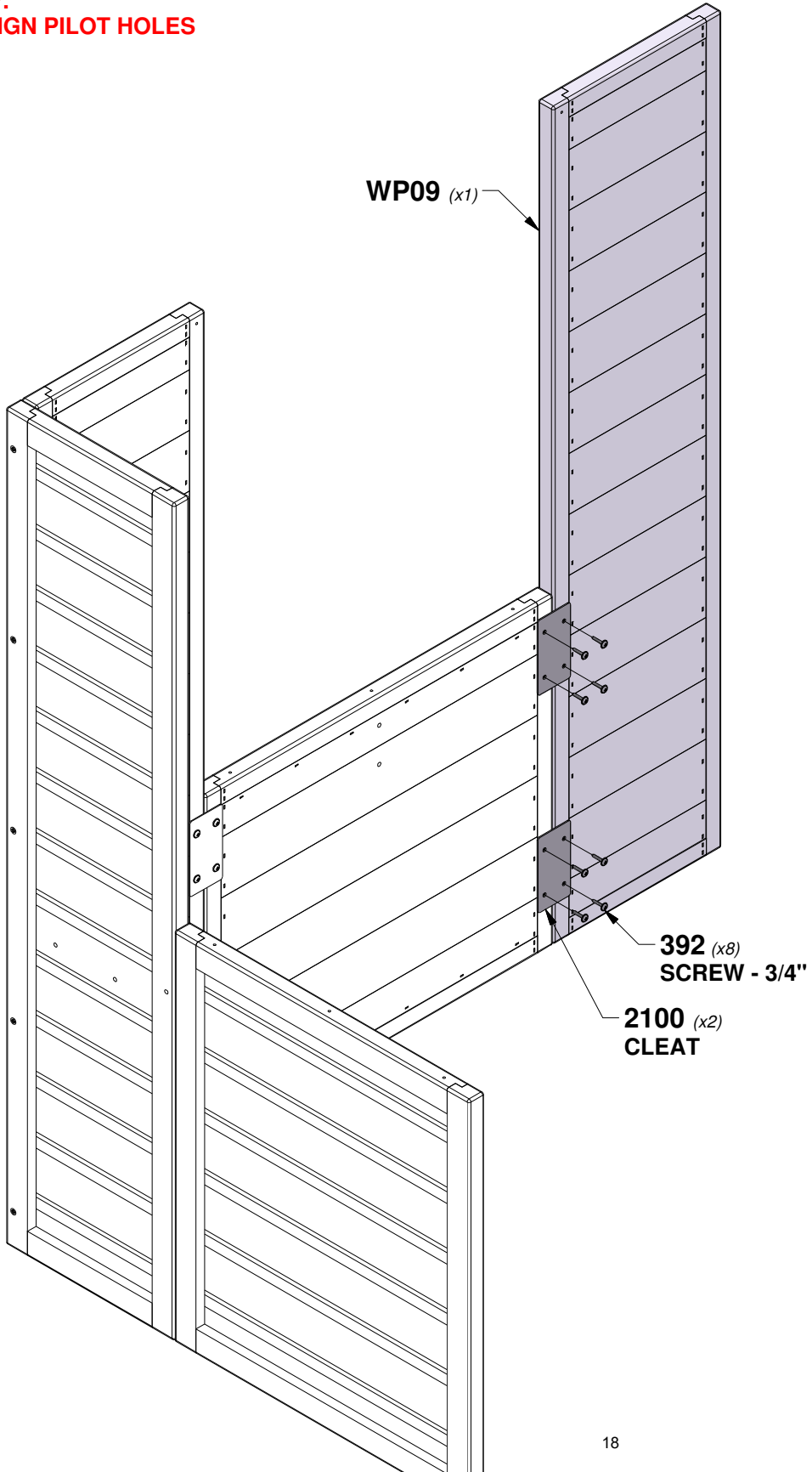

# STEP 5 - PLAYHOUSE ASSEMBLY

QTY	PART NUMBER	DESCRIPTION
5	H100391	SCREW PFH 8x2 BLK

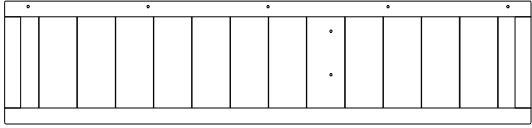

**WP12 WALL PANEL - W2A04224**  
(x1) 1"x10 1/4"x43 7/8" (24x260x1115)

**TIP:**  
**ALIGN PILOT HOLES**

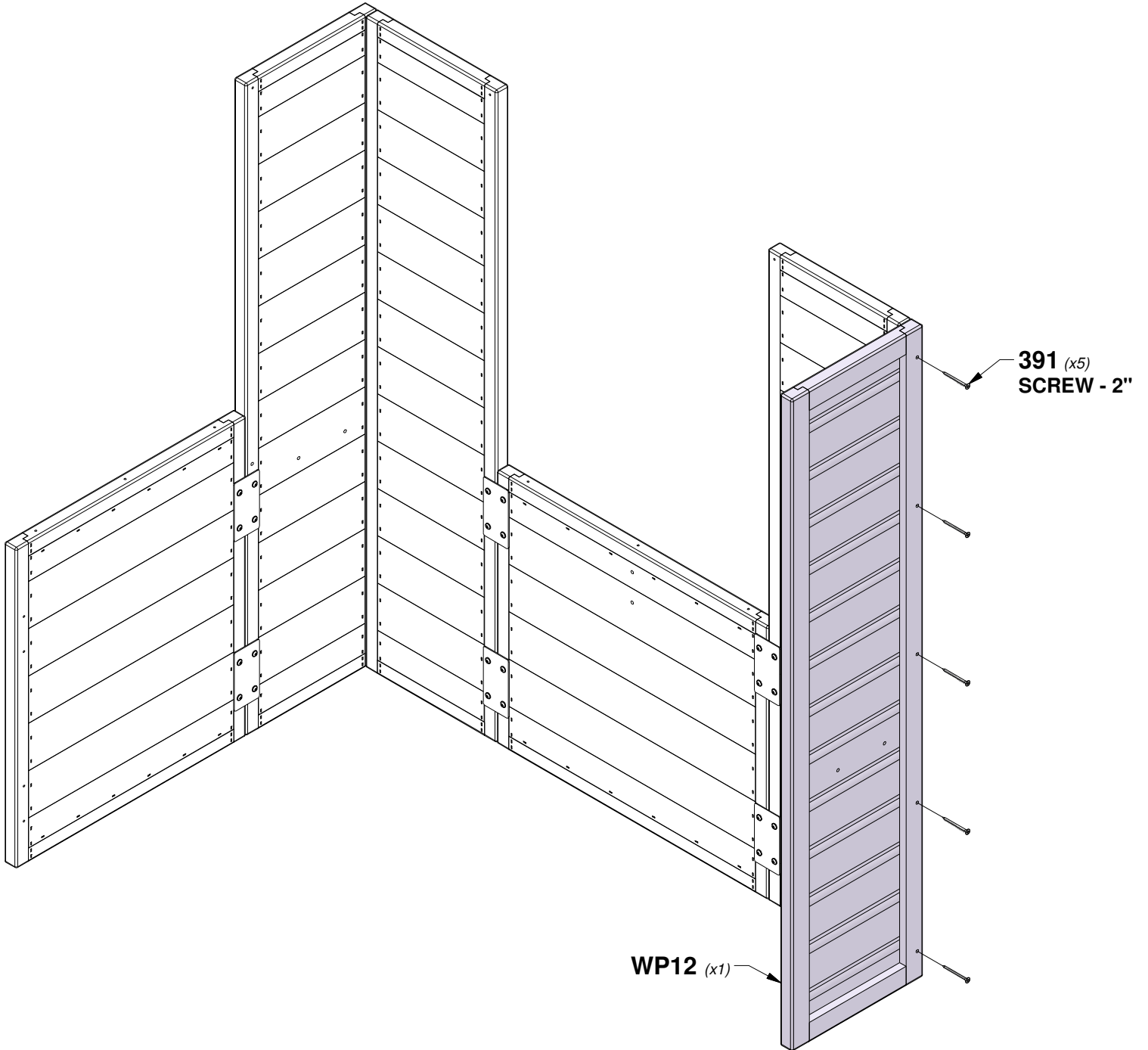

# STEP 6 - PLAYHOUSE ASSEMBLY

QTY	PART NUMBER	DESCRIPTION
8	H100392	SCREW PWH 8x3/4 BLK

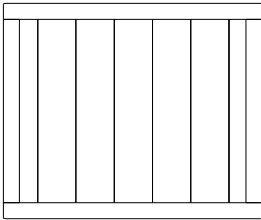

**WP04 WALL PANEL - W2A04143**  
(x1) 1"x10 1/4"x43 7/8" (24x455x548)

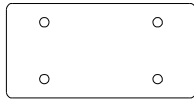

**A4M02100 CLEAT**  
(x2)

**TIP:**  
**ALIGN PILOT HOLES**

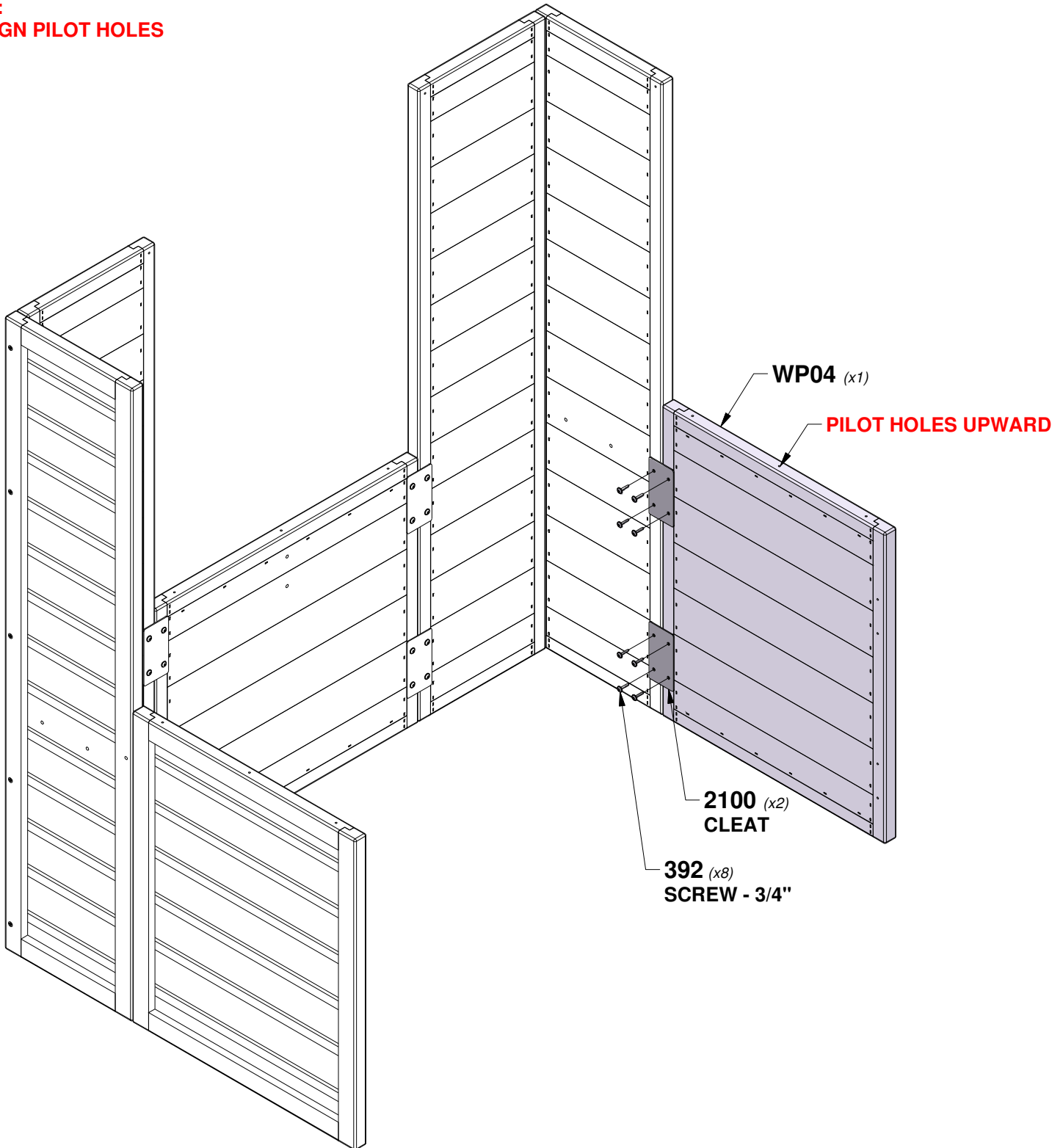

# STEP 7 - PLAYHOUSE ASSEMBLY

QTY	PART NUMBER	DESCRIPTION
8	H100392	SCREW PWH 8x3/4 BLK

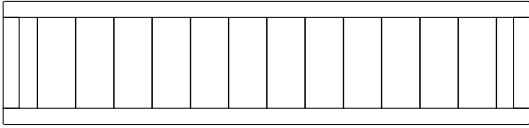

**WP10 WALL PANEL - W2A04221**  
 (x1) 1"x10 1/4"x43 7/8" (24x260x1115)



**A4M02100 CLEAT**  
 (x2)

**TIP:**  
**ALIGN PILOT HOLES**

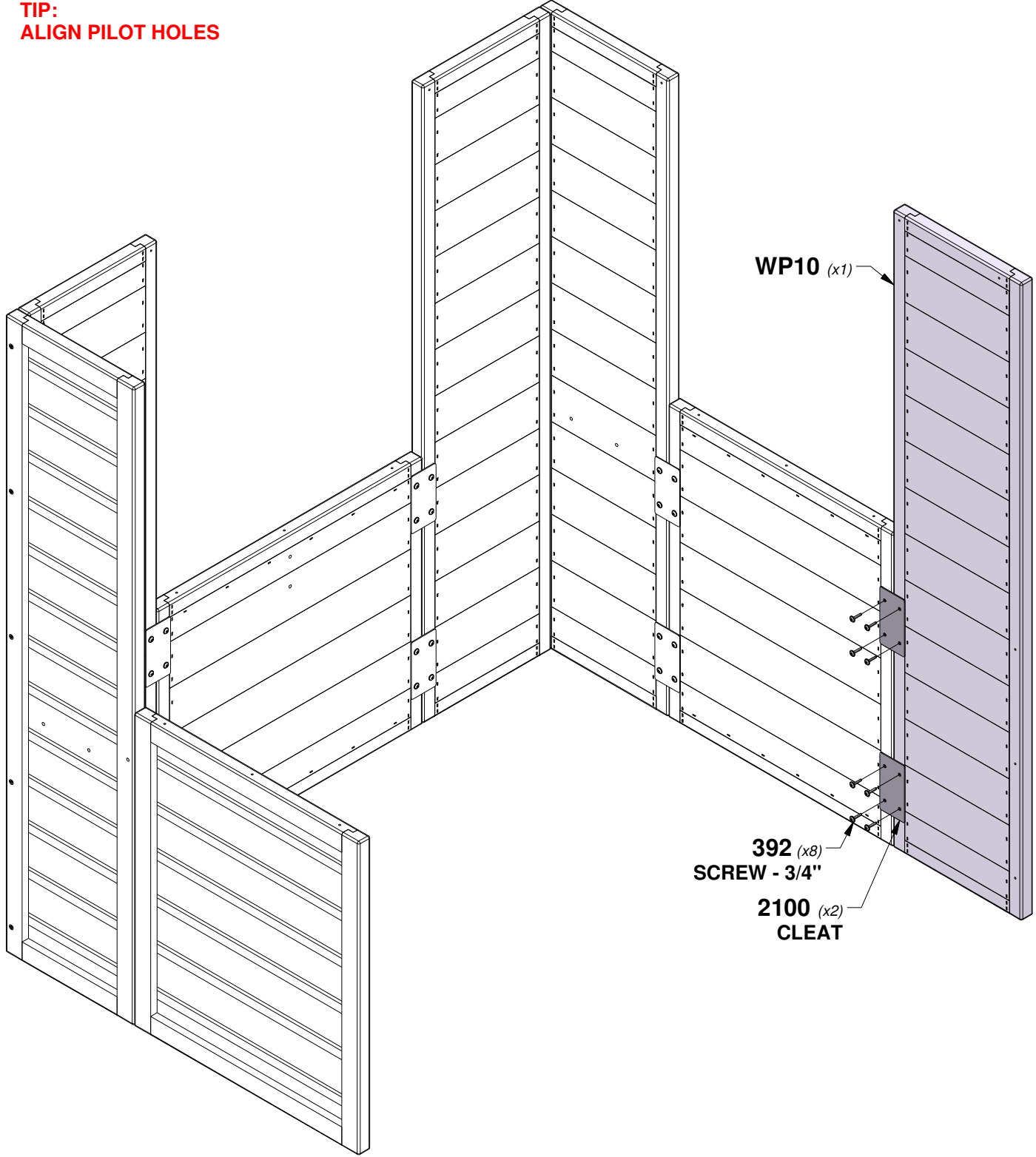

# STEP 8 - PLAYHOUSE ASSEMBLY

QTY	PART NUMBER	DESCRIPTION
8	H100392	SCREW PWH 8x3/4 BLK

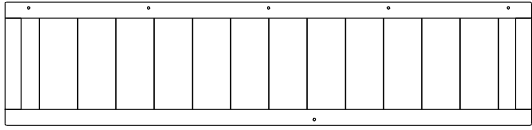

**WP03 WALL PANEL - W2A04142**  
 (x1) 1"x10 1/4"x43 7/8" (24x260x1115)



**A4M02100 CLEAT**  
 (x2)

**TIP:**  
**ALIGN PILOT HOLES**

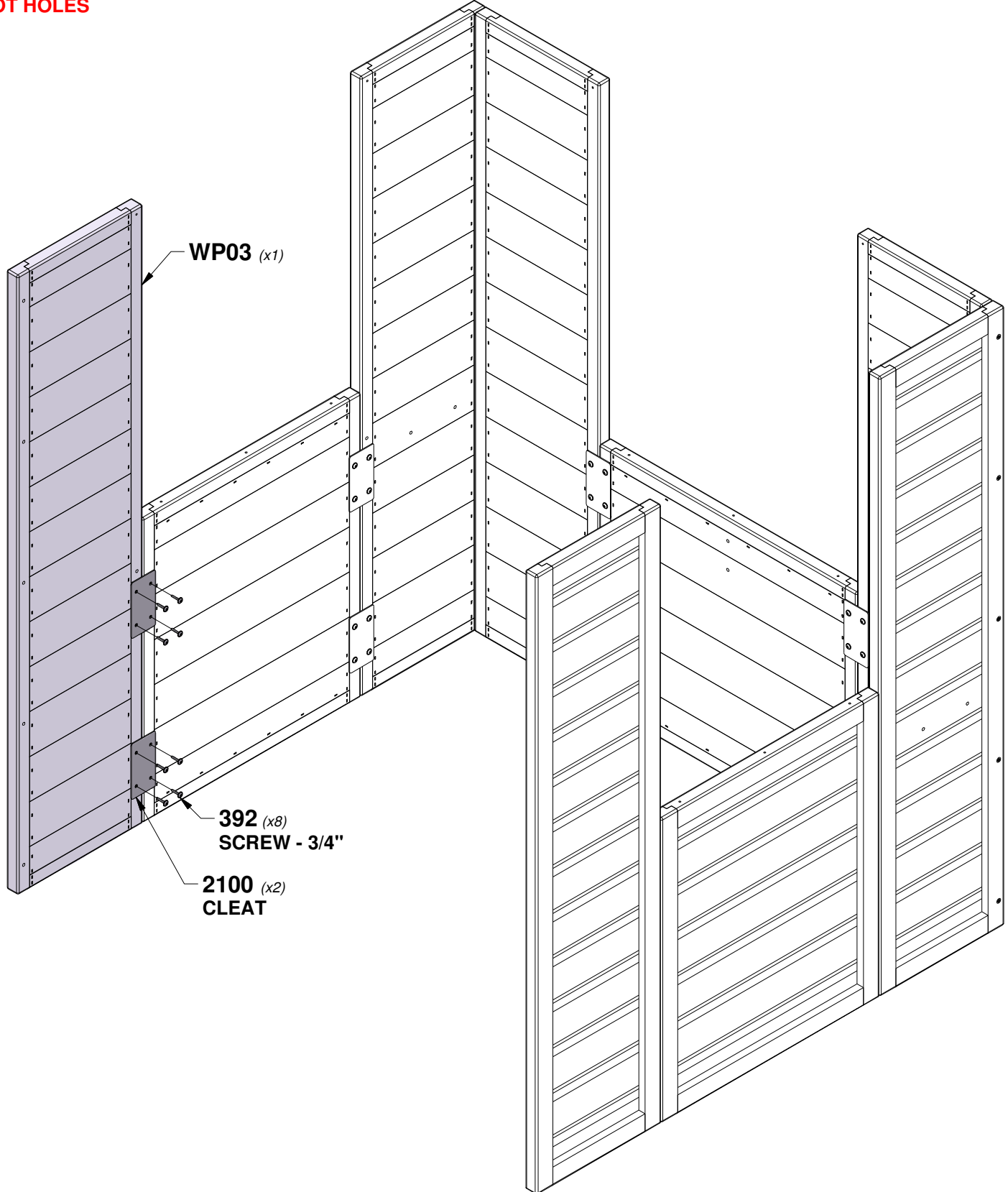

# STEP 9 - PLAYHOUSE ASSEMBLY

QTY	PART NUMBER	DESCRIPTION
5	H100391	SCREW PFH 8x2 BLK

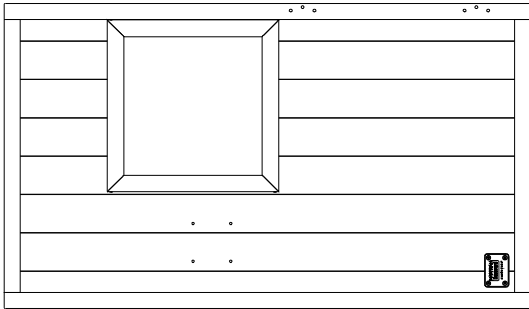

**WP07 WALL PANEL - W2A04146**  
(x1) 1"x10 1/4"x43 7/8" (24x645x1115)

**TIP:**  
**ALIGN PILOT HOLES**

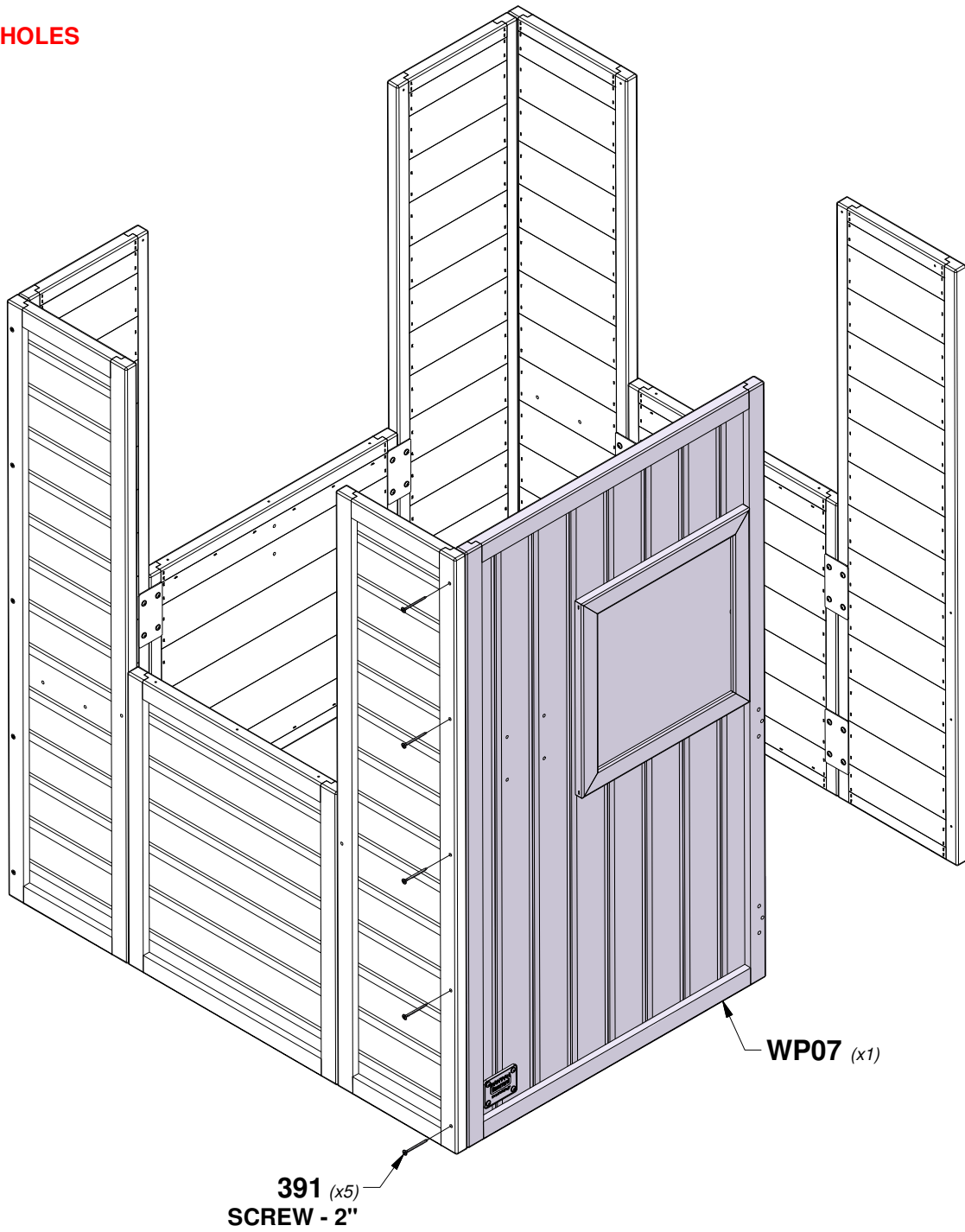

# STEP 10 - PLAYHOUSE ASSEMBLY

QTY	PART NUMBER	DESCRIPTION
7	H100392	SCREW PWH 8x3/4 BLK

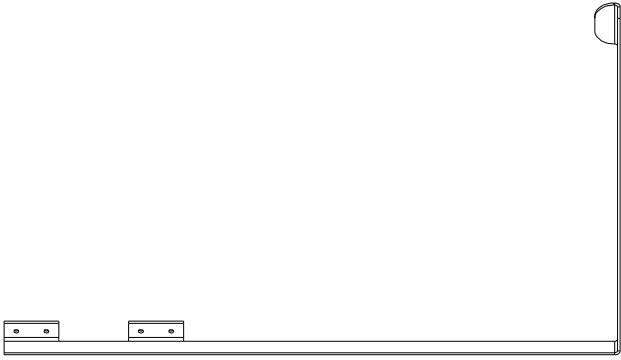

**A4M02754**  
*(x1)* METAL TIE STRAP

**TIP:**  
**ALIGN PILOT HOLES**

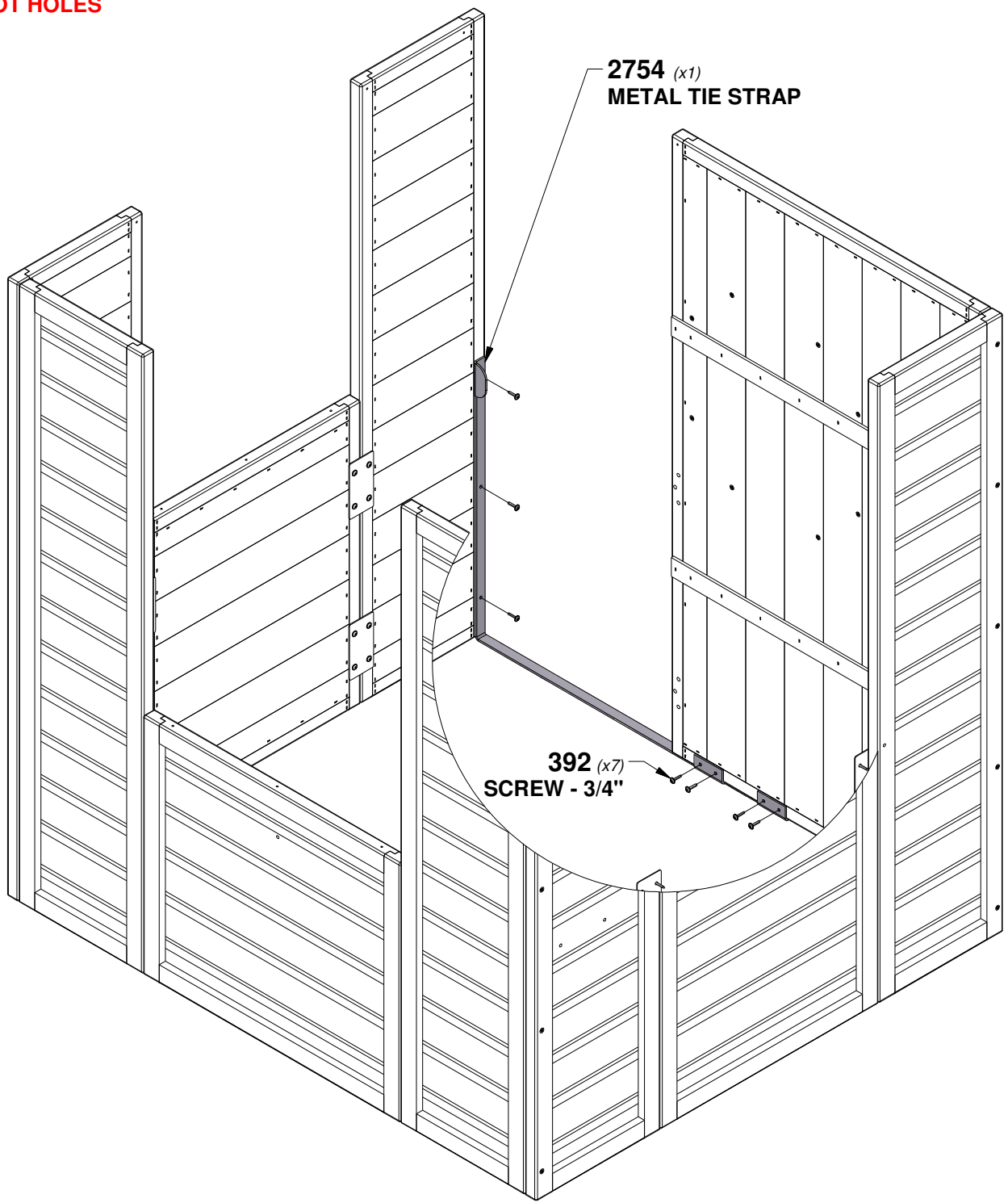

# STEP 11 - PLAYHOUSE ASSEMBLY

QTY	PART NUMBER	DESCRIPTION
2	H100200	SCREW PFH 8x1-1/2 BLK
4	H100387	SCREW PFH 8x1-1/4 BLK

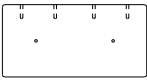

**H01 TABLE TOP SUPPORT - W4L19817**  
 (x2) 1"x3 3/8"x6 3/4" (24x86x172)

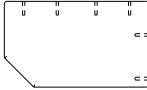

**AD01 TABLE TOP SUPPORT - W4L19818**  
 (x1) 1"x4"x6 3/4" (24x102x172)

**TIP:**  
**ALIGN PILOT HOLES**

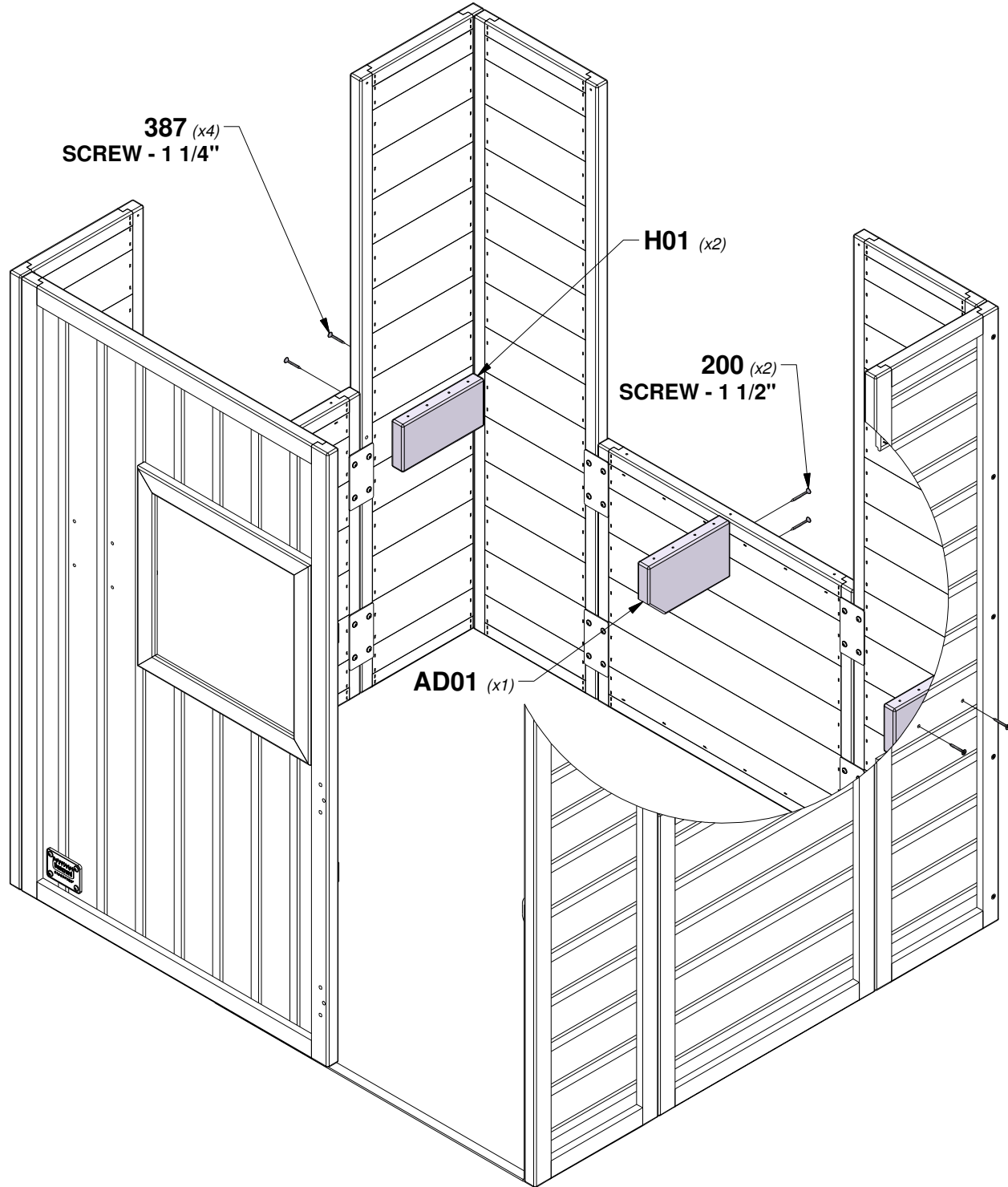

**387 (x4)**  
**SCREW - 1 1/4"**

**H01 (x2)**

**200 (x2)**  
**SCREW - 1 1/2"**

**AD01 (x1)**

# STEP 12 - PLAYHOUSE ASSEMBLY

QTY	PART NUMBER	DESCRIPTION
12	H100200	SCREW PFH 8x1-1/2 BLK

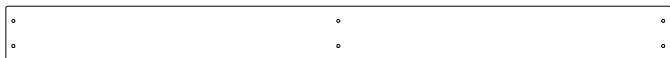

**M02 TABLE TOP - W4L19816**  
(x2) 5/8"x3 3/8"x41 5/8" (16x86x1056)

**TIP:**  
**ALIGN PILOT HOLES**

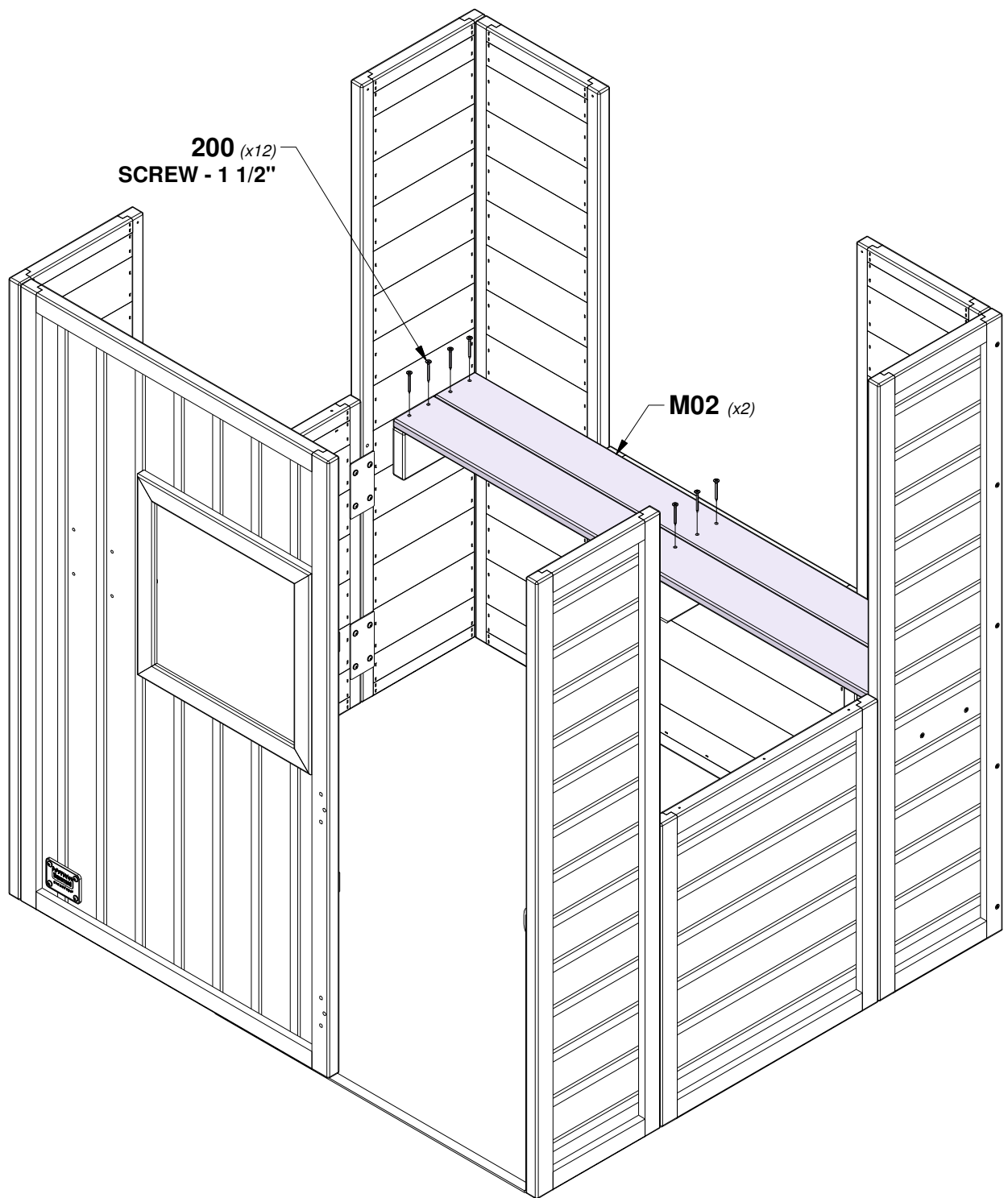

# STEP 13 - PLAYHOUSE ASSEMBLY

QTY	PART NUMBER	DESCRIPTION
2	H100200	SCREW PFH 8x1-1/2 BLK

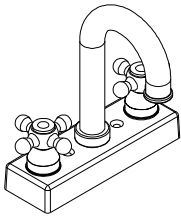

**A6P00024**  
*(x1)* FAUCET KIT

**PLACE AS DESIRED**

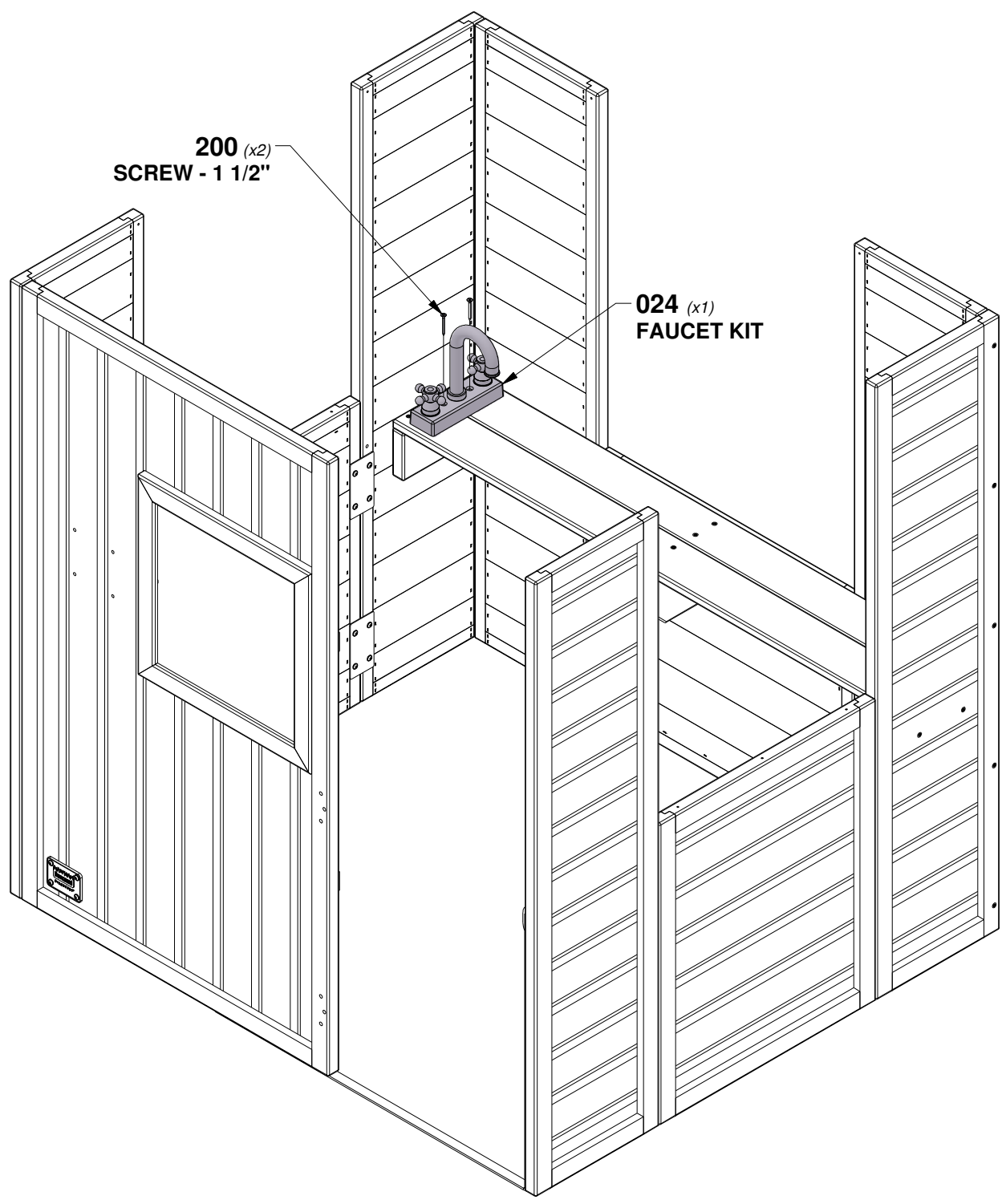

# STEP 14 - PLAYHOUSE ASSEMBLY

QTY	PART NUMBER	DESCRIPTION
2	H100202	SCREW PWH 8x5/8 BLK

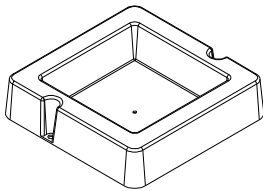

**A6P00032 SURFACE MOUNT BASIN**  
(x1)

**PLACE AS DESIRED**

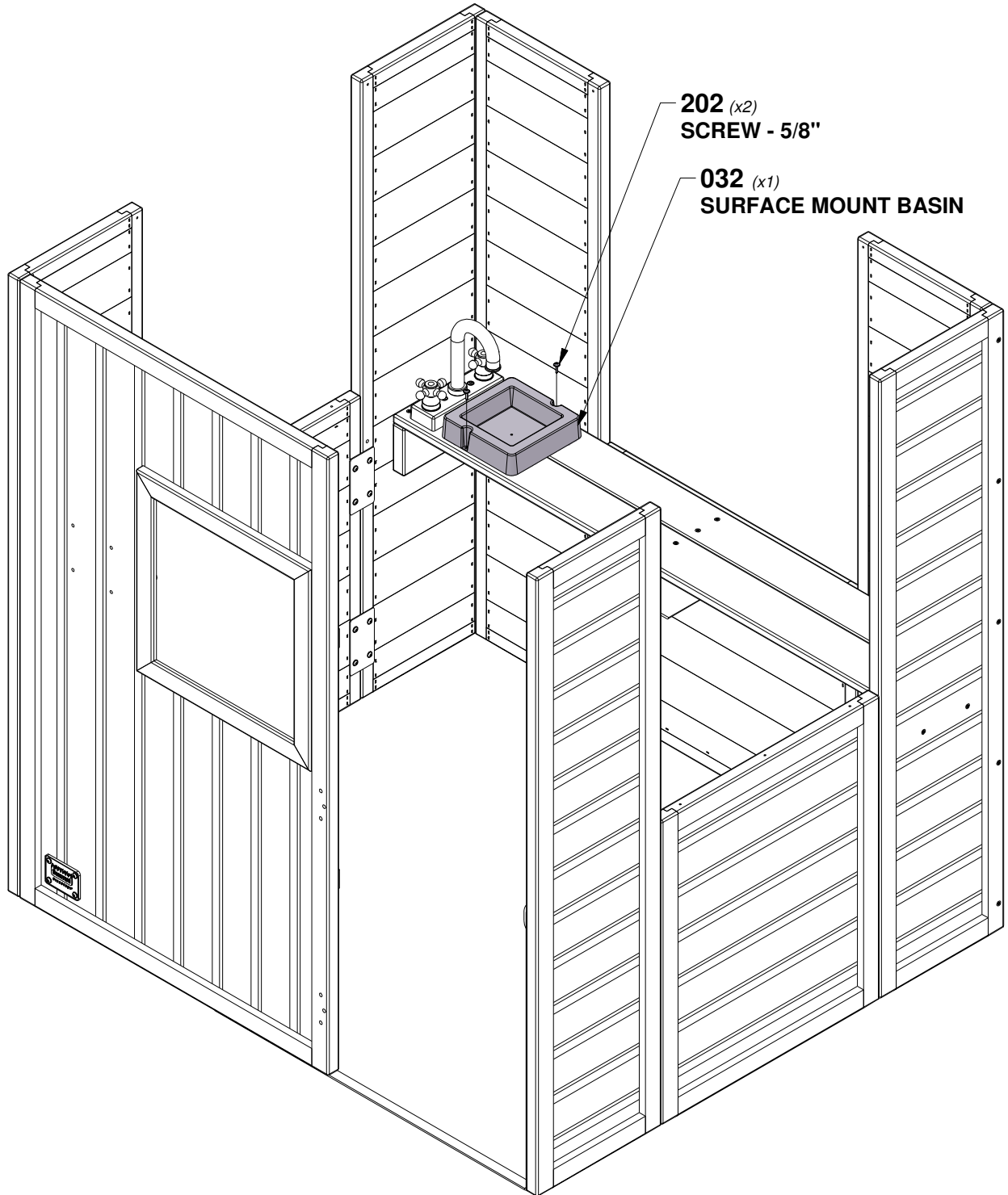

# STEP 15 - PLAYHOUSE ASSEMBLY

QTY	PART NUMBER	DESCRIPTION
4	H100385	SCREW PFH 8x1 BLK

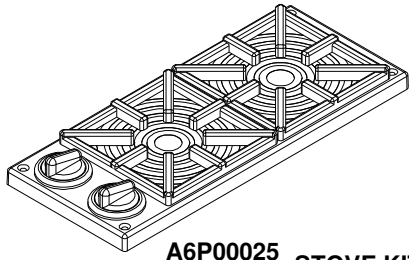

**A6P00025**  
*(x1)* STOVE KIT

**PLACE AS DESIRED**

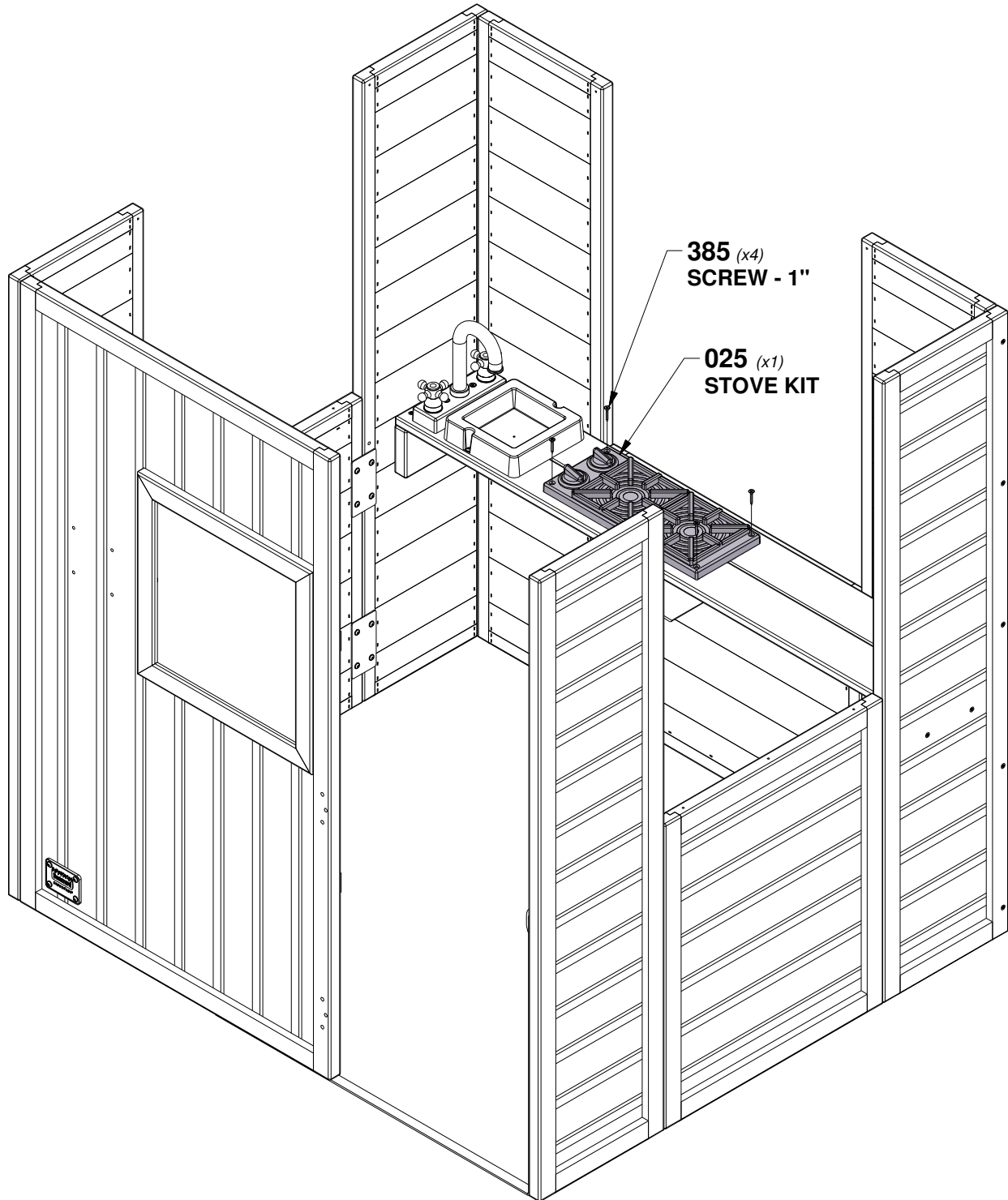

# STEP 16 - PLAYHOUSE ASSEMBLY

QTY	PART NUMBER	DESCRIPTION
4	H100392	SCREW PWH 8x3/4 BLK



**J01 TOP RAIL - W4L19821**  
 (x1) 1"x1 3/8"x41 5/8" (24x34x1057)

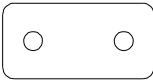

**A4M02752 CLEAT**  
 (x2)

**TIP:**  
**ALIGN PILOT HOLES**

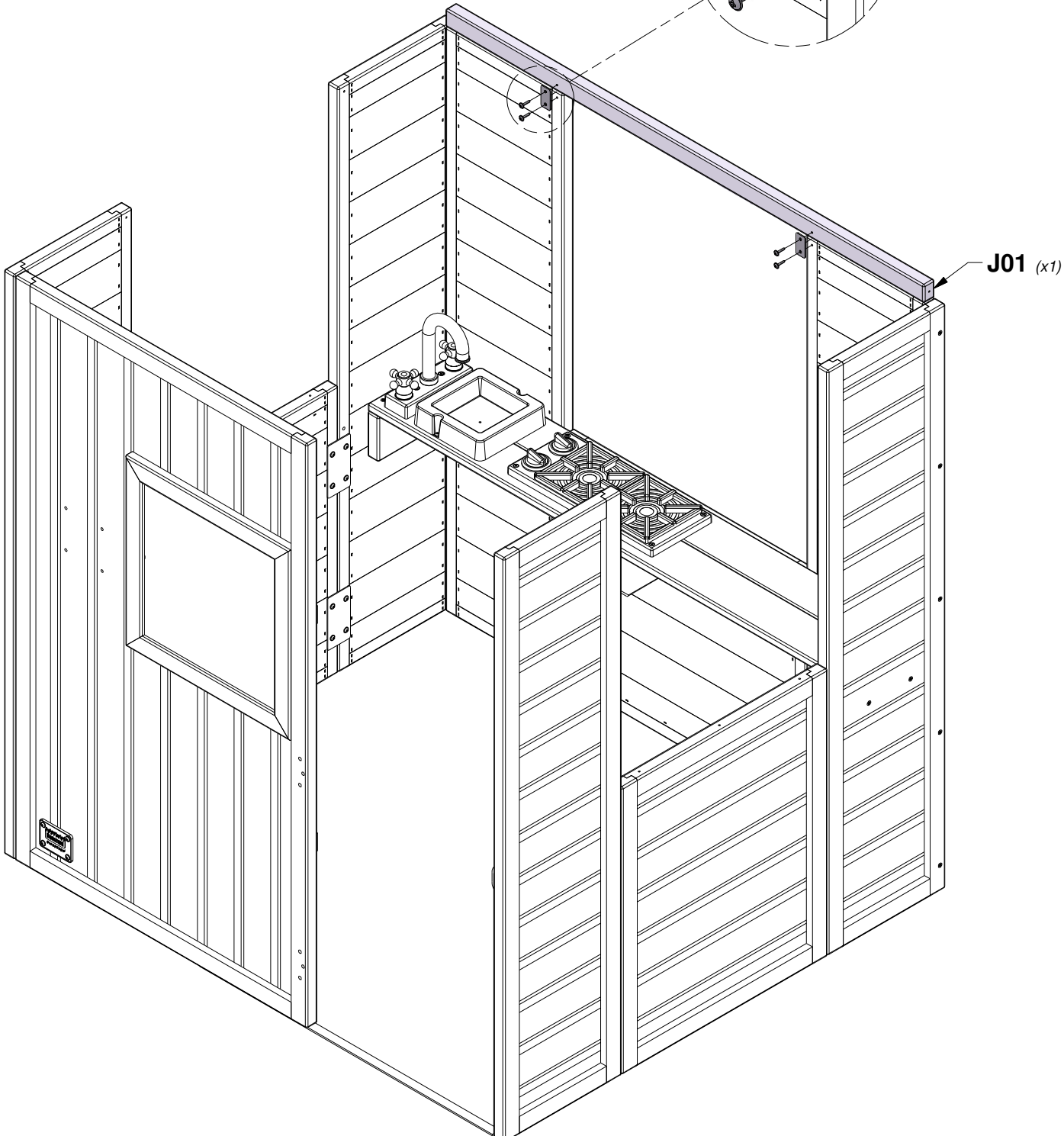
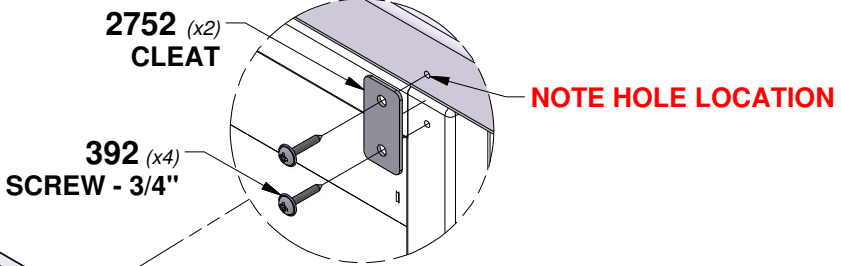

# STEP 17 - PLAYHOUSE ASSEMBLY

QTY	PART NUMBER	DESCRIPTION
1	H100391	SCREW PFH 8x2 BLK
4	H100392	SCREW PWH 8x3/4 BLK

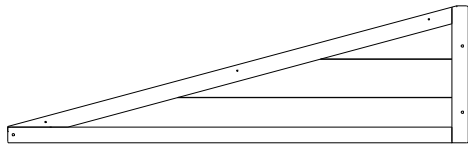

**WP08 WALL PANEL - W2A04147**  
 (x1) 1"x11 3/8"x38 3/8" (24x290x975)

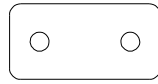

**A4M02752 CLEAT**  
 (x2)

**TIP:**  
**ALIGN PILOT HOLES**

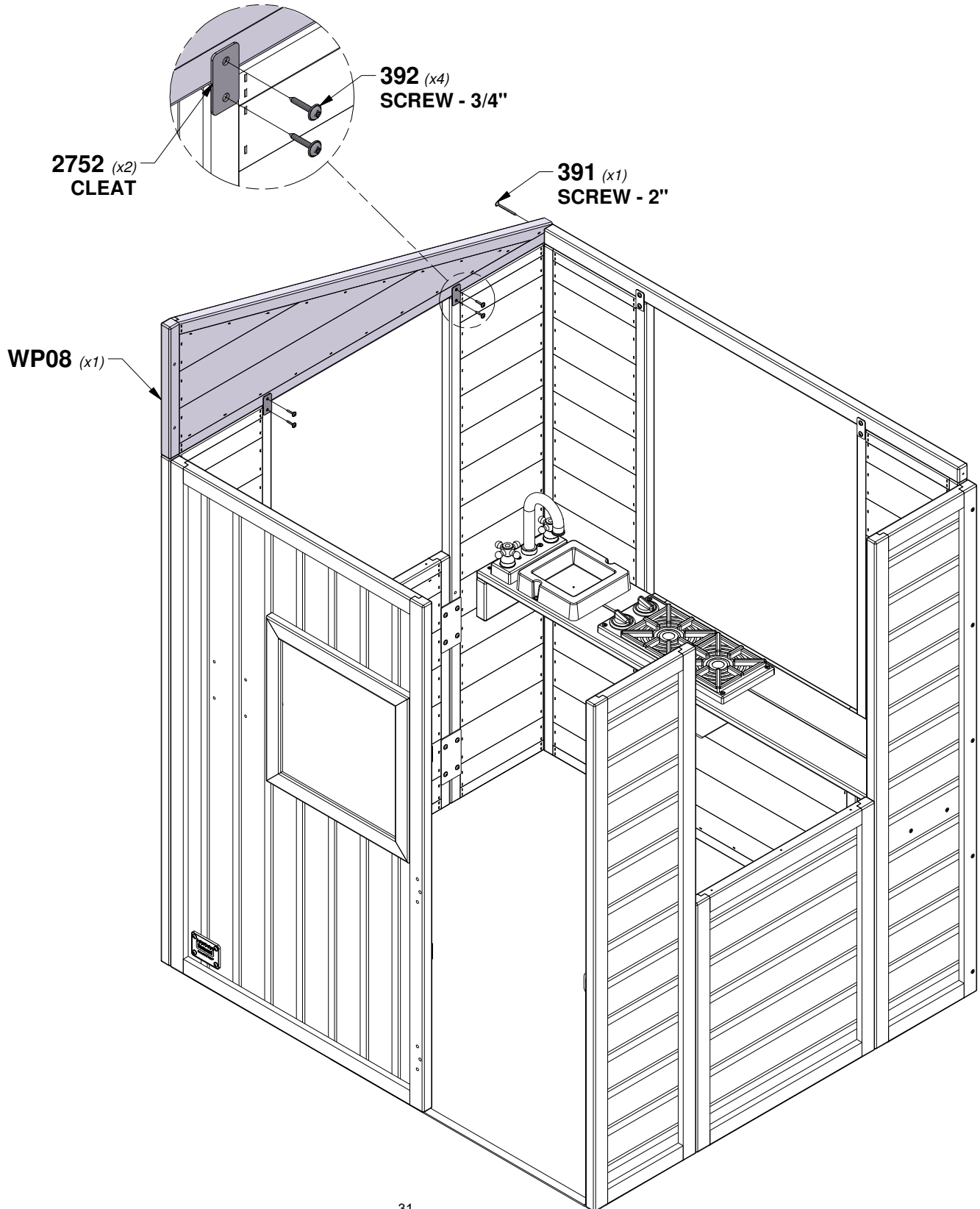

# STEP 18 - PLAYHOUSE ASSEMBLY

QTY	PART NUMBER	DESCRIPTION
1	H100391	SCREW PFH 8x2 BLK
6	H100392	SCREW PWH 8x3/4 BLK

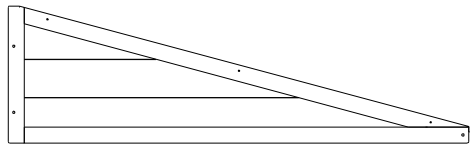

**WP06 WALL PANEL - W2A04145**  
 (x1) 1"x11 3/8"x38 3/8" (24x290x975)

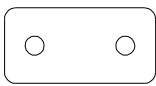

**A4M02752 CLEAT**  
 (x3)

**TIP:**  
**ALIGN PILOT HOLES**

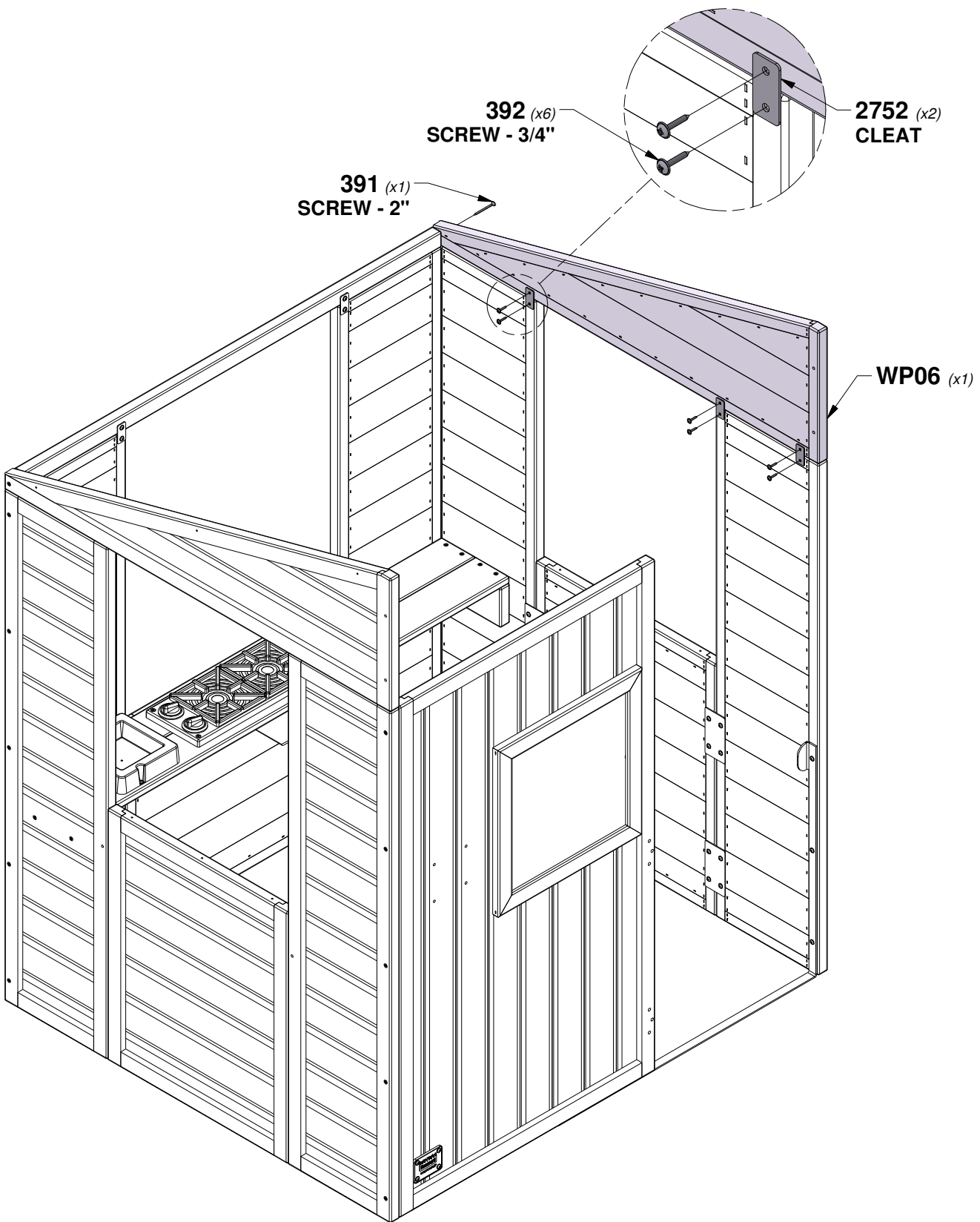

# STEP 19 - PLAYHOUSE ASSEMBLY

QTY	PART NUMBER	DESCRIPTION
4	H100391	SCREW PFH 8x2 BLK
2	H100392	SCREW PWH 8x3/4 BLK

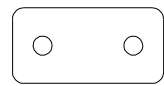
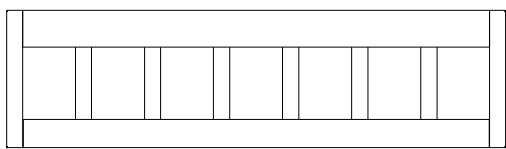

**WP11 WALL PANEL - W2A04222**  
 (x1) 15/16"x11 7/16"x41 5/8" (24x290x1057)

**A4M02752 CLEAT**  
 (x1)

**TIP:**  
**ALIGN PILOT HOLES**

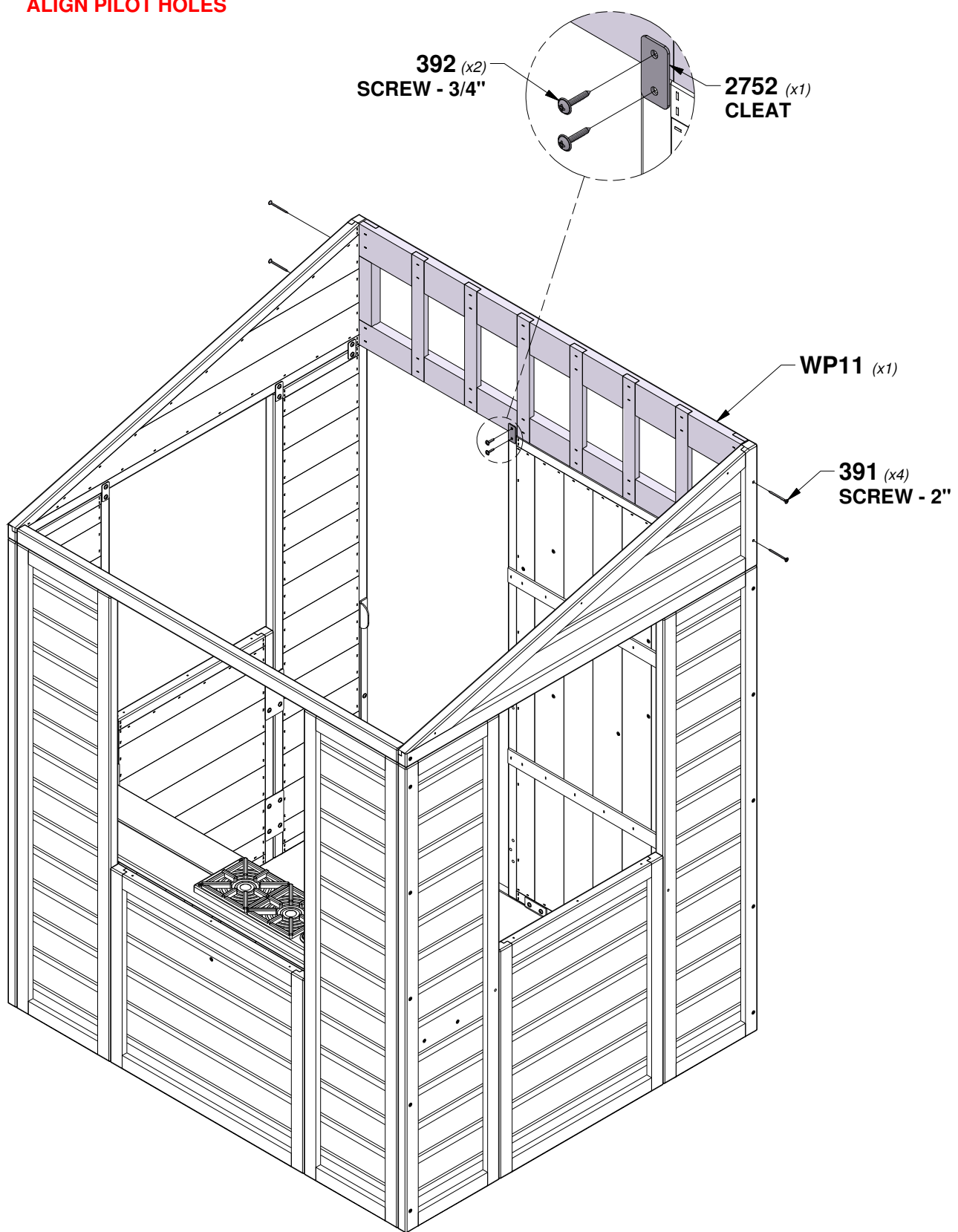

# STEP 20 - PLAYHOUSE ASSEMBLY

QTY	PART NUMBER	DESCRIPTION
3	H100382	SCREW PFH 8x1 3/4 BLK

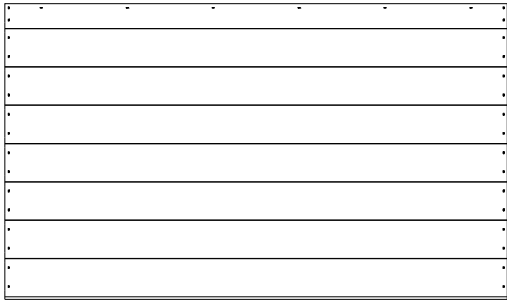

**RP01 ROOF PANEL - W2A04130**  
(x1) 1 3/8"x24 5/8"x41 7/8" (35x625x1064)

**TIP:**  
**ALIGN PILOT HOLES**

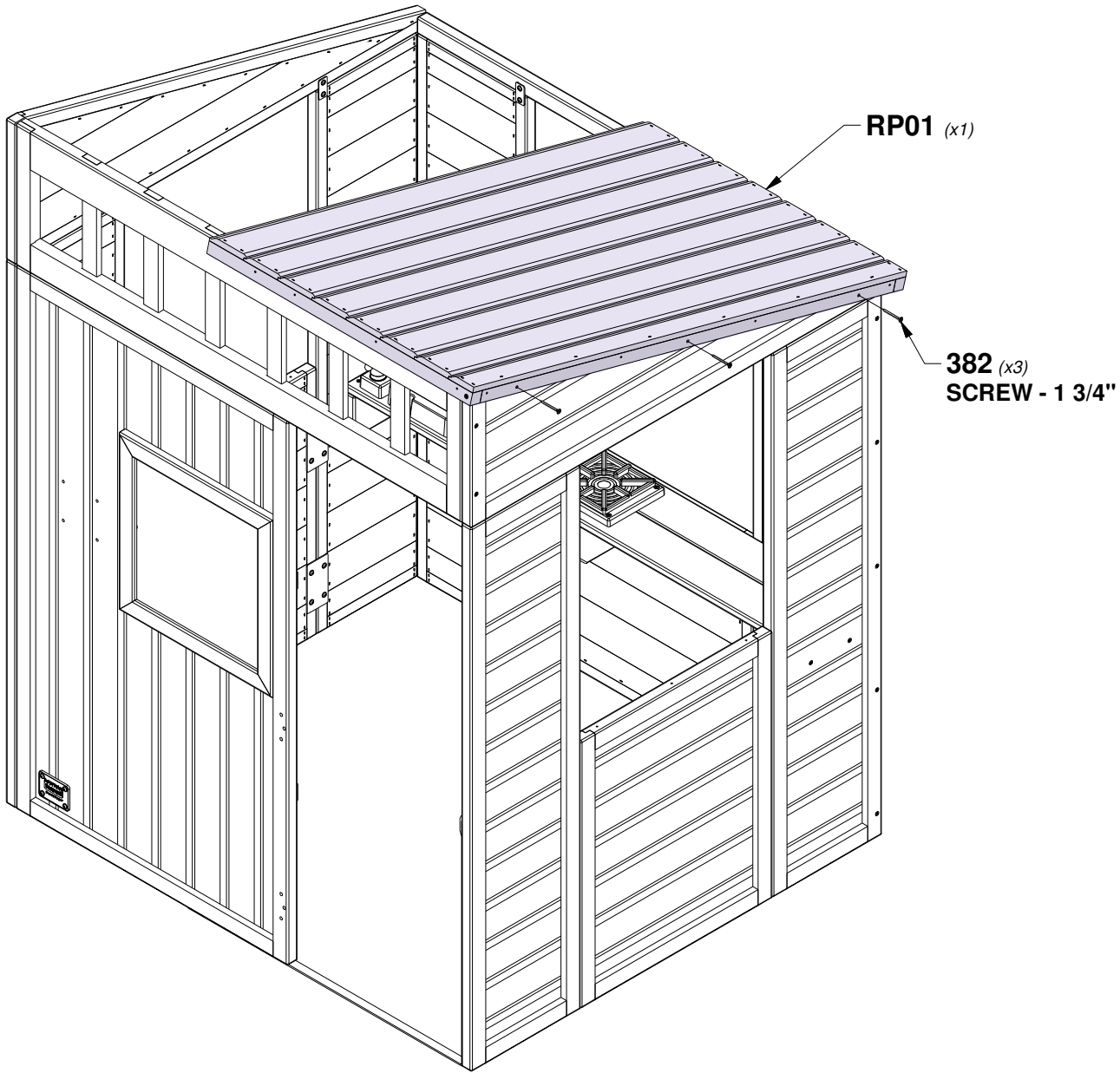

# STEP 21 - PLAYHOUSE ASSEMBLY

QTY	PART NUMBER	DESCRIPTION
3	H100382	SCREW PFH 8x1 3/4 BLK

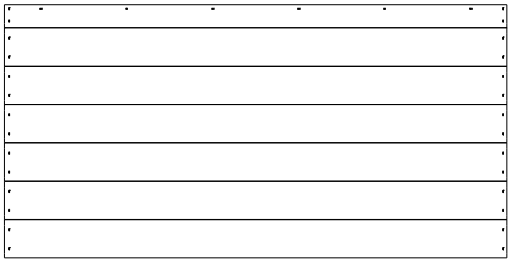

**RP02 ROOF PANEL - W2A04131**  
(x1) 1 3/8"x21 1/8"x41 7/8" (35x535x1064)

**TIP:**  
**ALIGN PILOT HOLES**

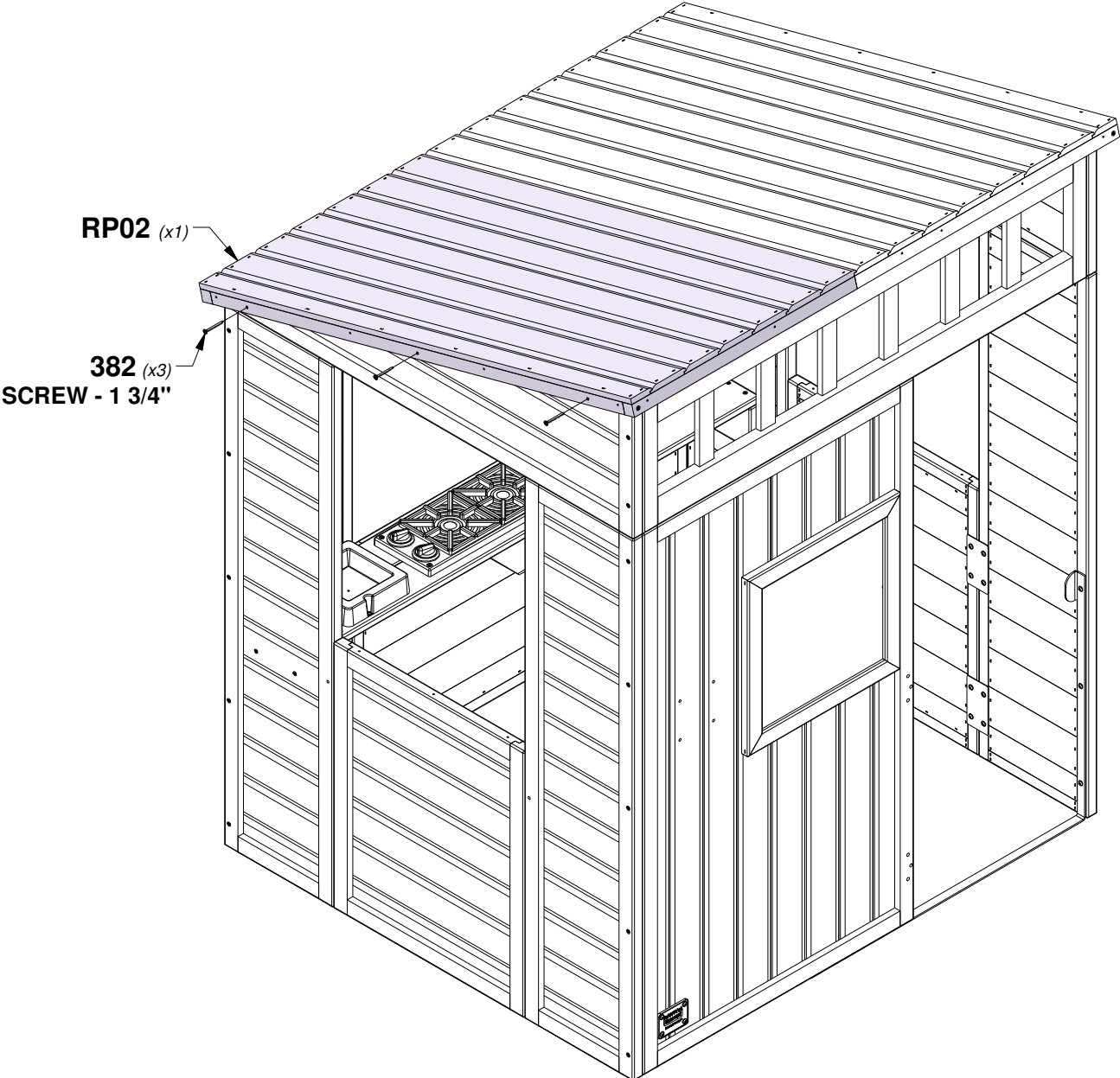

# STEP 22 - PLAYHOUSE ASSEMBLY

QTY	PART NUMBER	DESCRIPTION
6	H100387	SCREW PFH 8x1-1/4 BLK

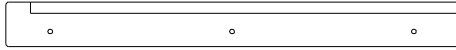

**F03 ROOF TRIM - W4L19820**  
(x1) 1"x1 7/8"x18 7/8" (26x47x479)

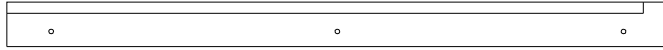

**F02 ROOF TRIM - W4L19316**  
(x1) 1"x1 7/8"x27 1/2" (26x47x700)

**TIP:**  
**ALIGN PILOT HOLES**

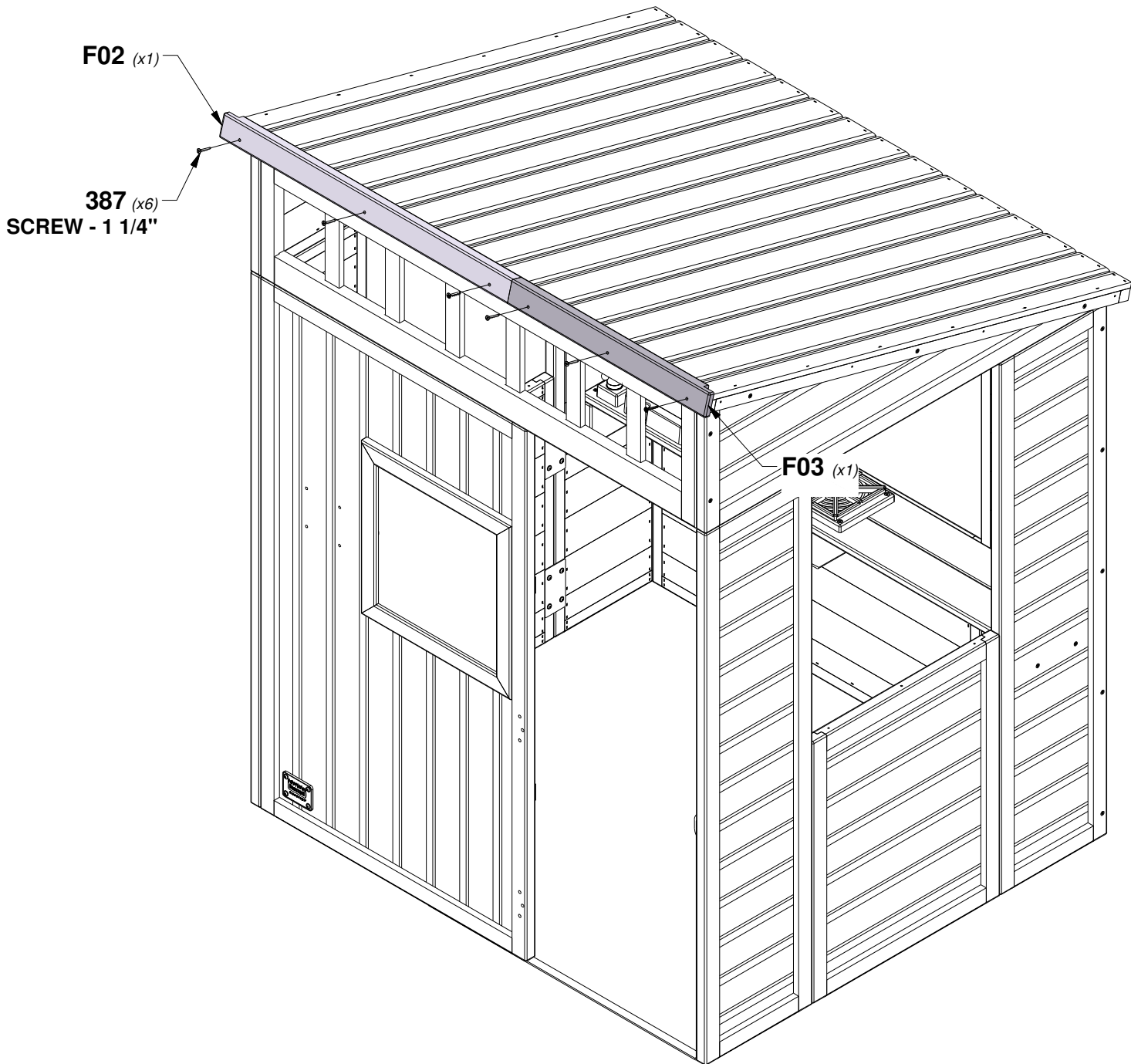

# STEP 23 - PLAYHOUSE ASSEMBLY

QTY	PART NUMBER	DESCRIPTION
4	H100387	SCREW PFH 8x1-1/4 BLK



**F01 ROOF TRIM - W4L19315**  
(x1) 1"x1 7/8"x41 7/8" (26x47x1064)

**TIP:**  
**ALIGN PILOT HOLES**

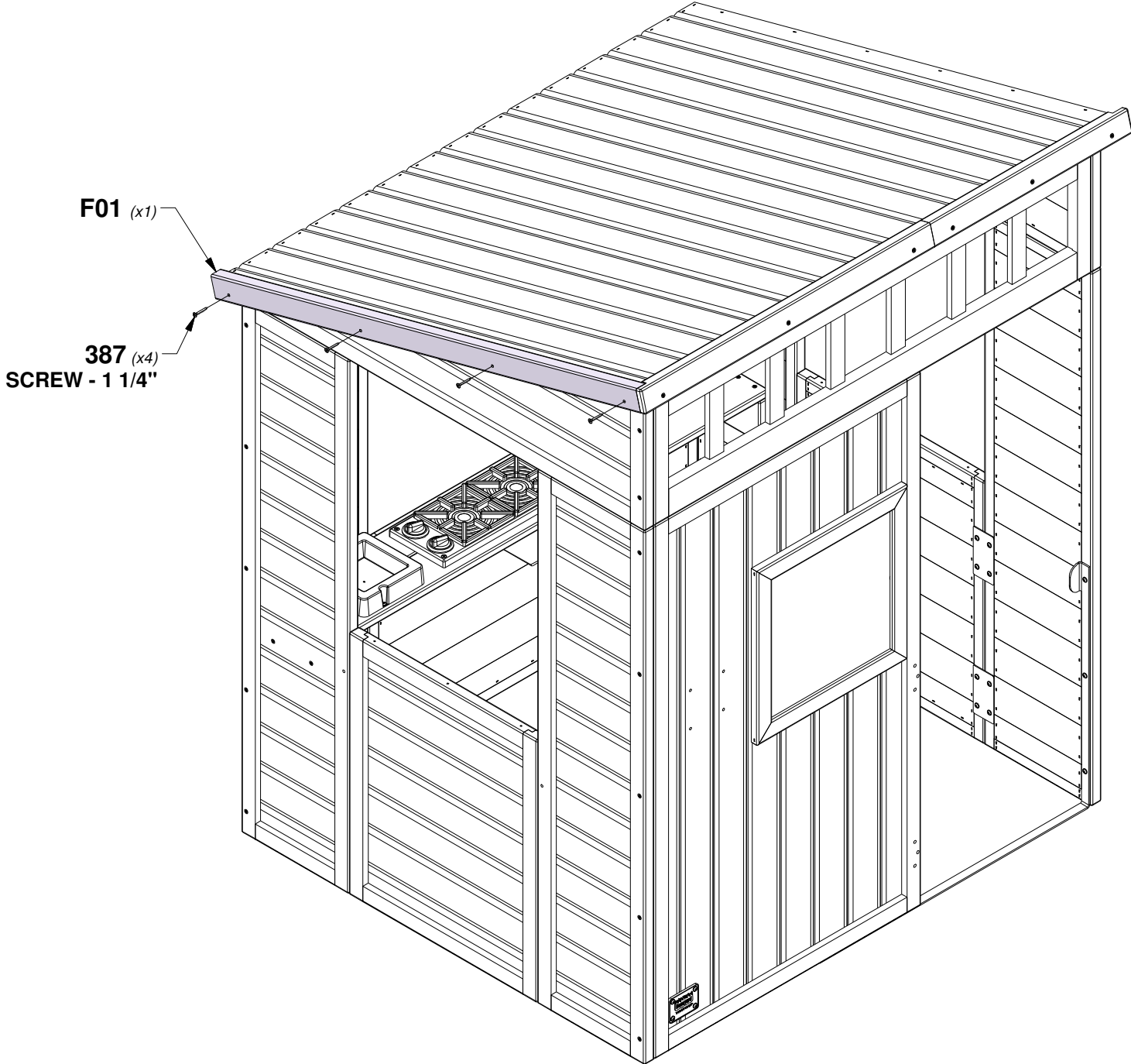

# STEP 24 - PLAYHOUSE ASSEMBLY

QTY	PART NUMBER	DESCRIPTION
4	H100387	SCREW PFH 8x1-1/4 BLK



**F01 ROOF TRIM - W4L19315**  
(x1) 1"x1 7/8"x41 7/8" (26x47x1064)

**TIP:**  
**ALIGN PILOT HOLES**

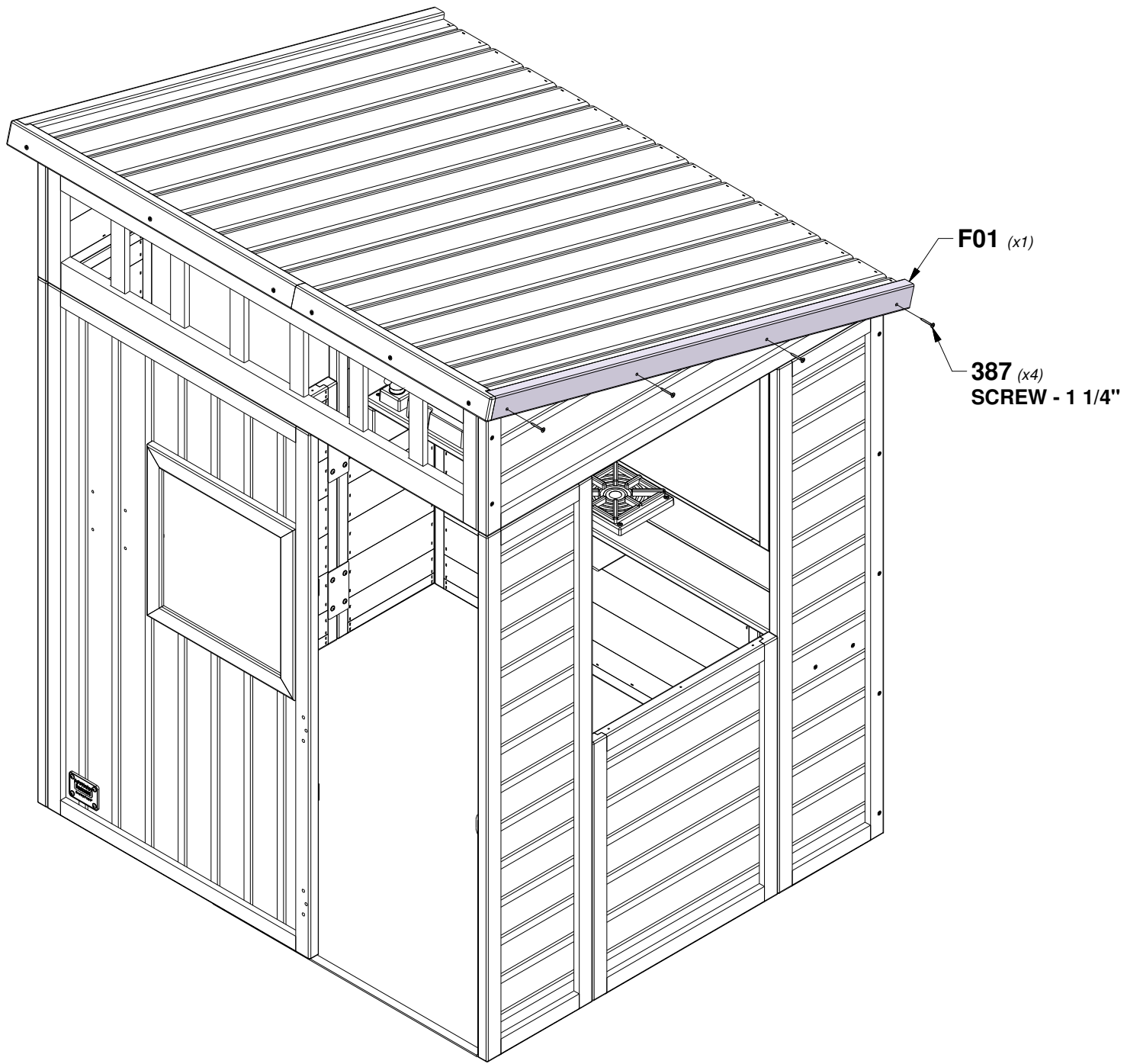

# STEP 25 - PLAYHOUSE ASSEMBLY

QTY	PART NUMBER	DESCRIPTION
7	H100387	SCREW PFH 8x1-1/4 BLK

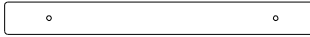

**N04 ROOF TRIM - W4L19819**  
(x1) 5/8"x1 3/8"x12 3/4" (16x34x324)

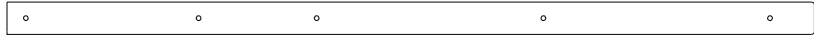

**N03 ROOF TRIM - W4L19317**  
(x1) 5/8"x1 3/8"x33 5/8" (16x34x855)

**TIP:**  
**ALIGN PILOT HOLES**

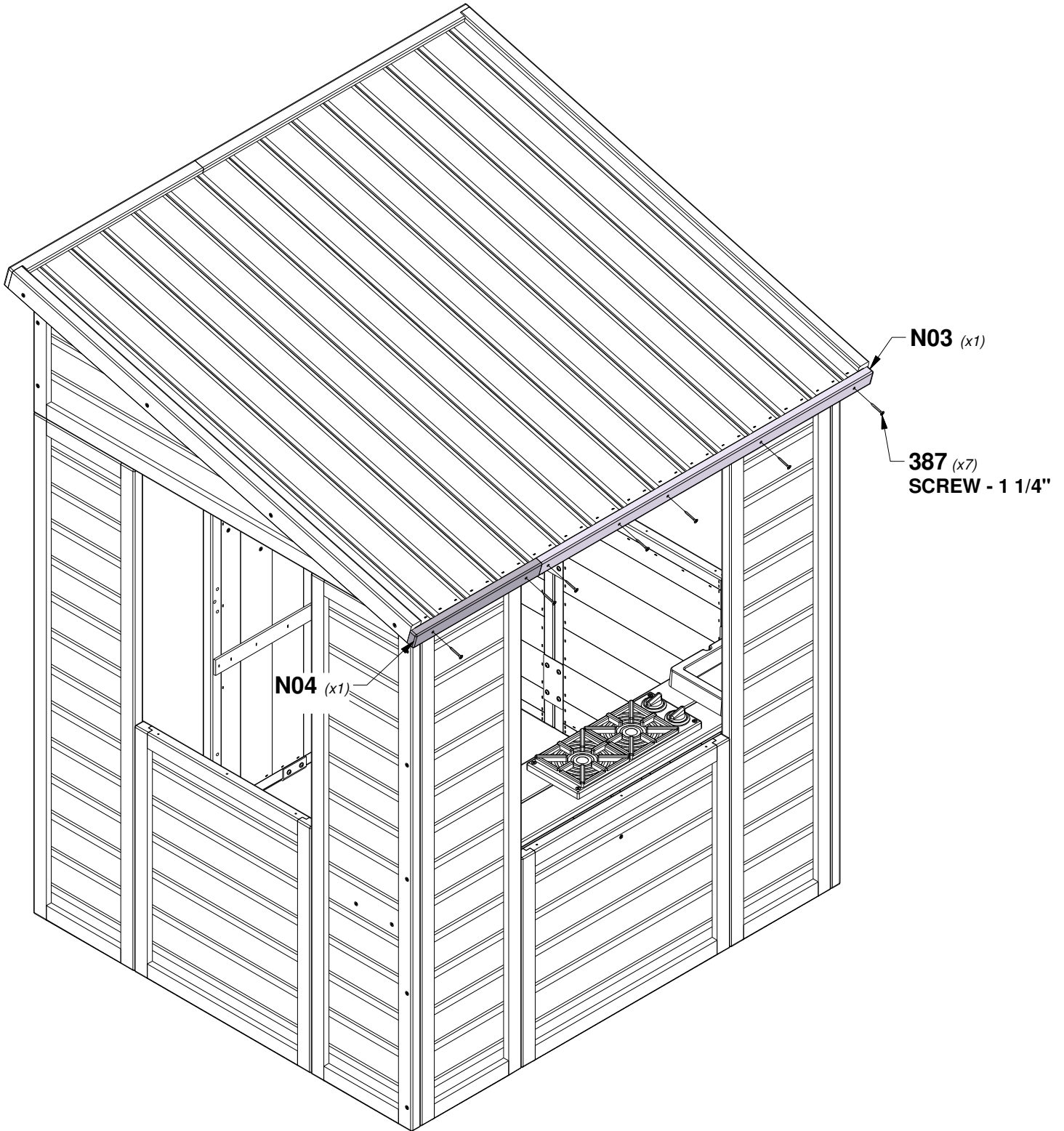

# STEP 26 - PLAYHOUSE ASSEMBLY

QTY	PART NUMBER	DESCRIPTION
12	H100804	T-NUT 8/32
12	H100807	SCREW POH-MS 8/32x1 BLK

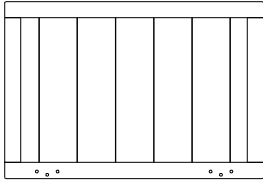

**DP01 DOOR PANEL - W2A04148**  
(x1) 1"x10 1/4"x43 7/8" (24x374x548)



**A4M00624 HINGE (DOOR, SPRING LOADED)**  
(x1)



**A4M00994 HINGE (DOOR, NON-SPRING LOADED)**  
(x1)

**TIP:**  
**INSTALL T-NUTS IN WOOD FIRST**

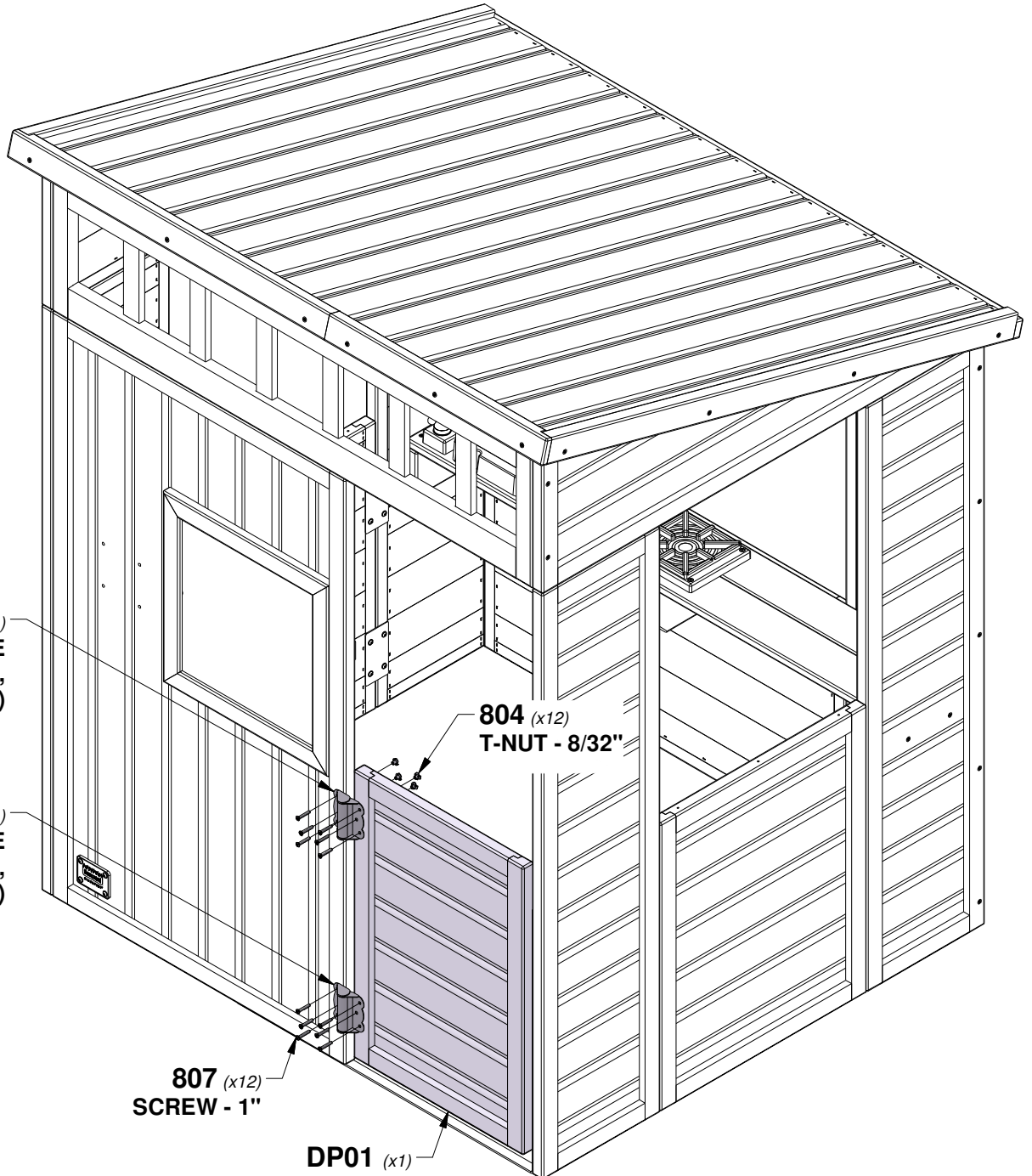

**624 (x1) HINGE (DOOR, SPRING LOADED)**

**994 (x1) HINGE (DOOR, NON-SPRING LOADED)**

**804 (x12) T-NUT - 8/32"**

**807 (x12) SCREW - 1"**

**DP01 (x1)**

# STEP 27 - PLAYHOUSE ASSEMBLY

QTY	PART NUMBER	DESCRIPTION
4	H100797	SCREW PWH 8x1 BLK

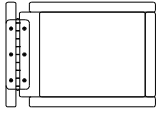

**MB01 MAILBOX - W2A04223**  
(x1) 3 3/8"x6 9/16"x8 3/4" (86x166x222)

**TIP:**  
**ALIGN PILOT HOLES**

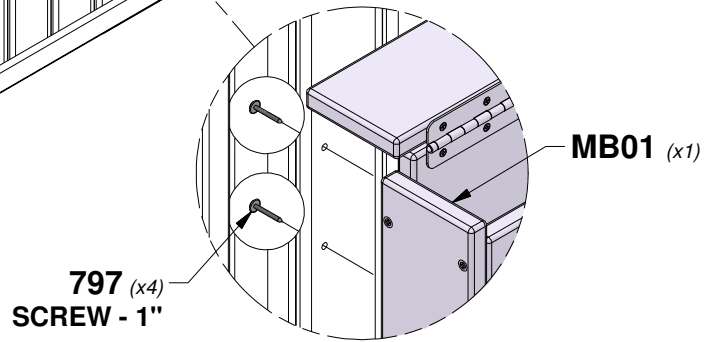
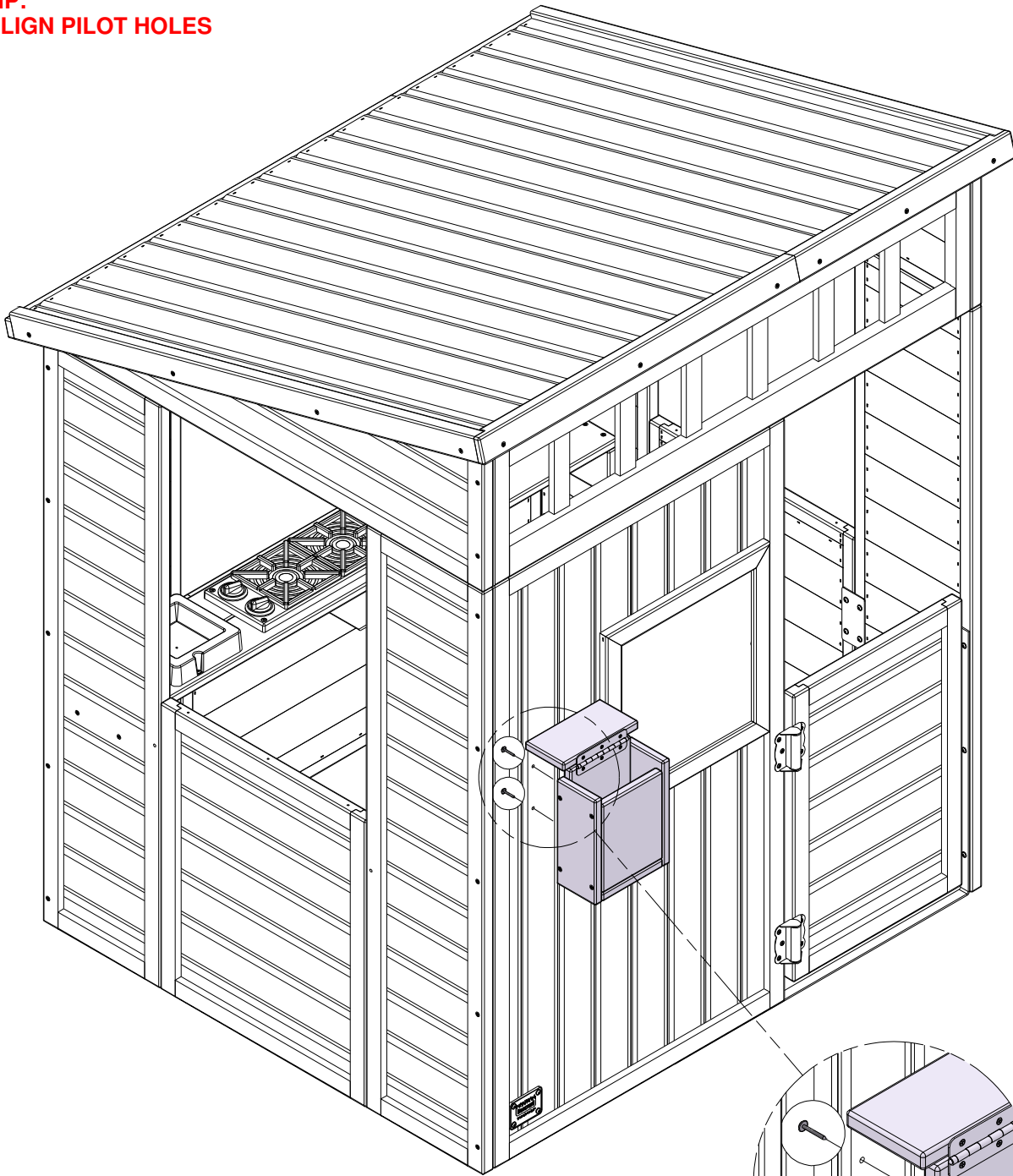

# STEP 28 - PLAYHOUSE ASSEMBLY

QTY	PART NUMBER	DESCRIPTION
2	H100391	SCREW PFH 8x2 BLK

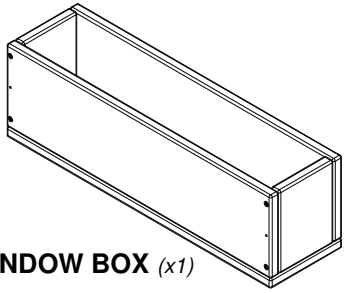

WINDOW BOX (x1)

**TIP:**  
**ALIGN PILOT HOLES**

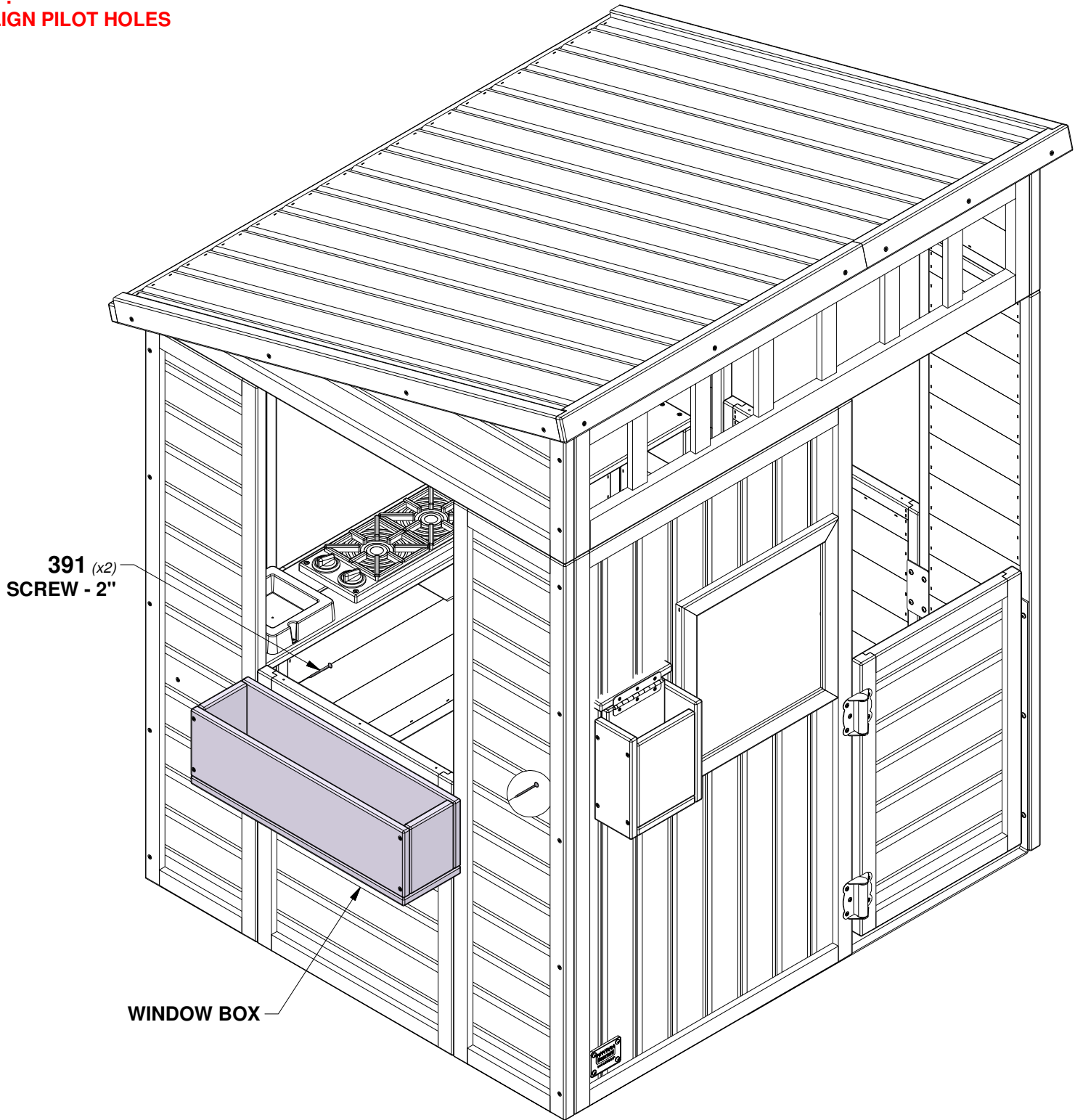

# STEP 29 - PLAYHOUSE ASSEMBLY

QTY	PART NUMBER	DESCRIPTION
3	H100200	SCREW PFH 8x1-1/2 BLK

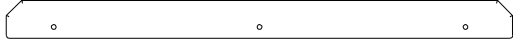

**N02 WINDOW BOARD - W4L19310**  
(x1) 5/8"x1 5/8"x21 1/8" (16x40x536)

**TIP:**  
**ALIGN PILOT HOLES**

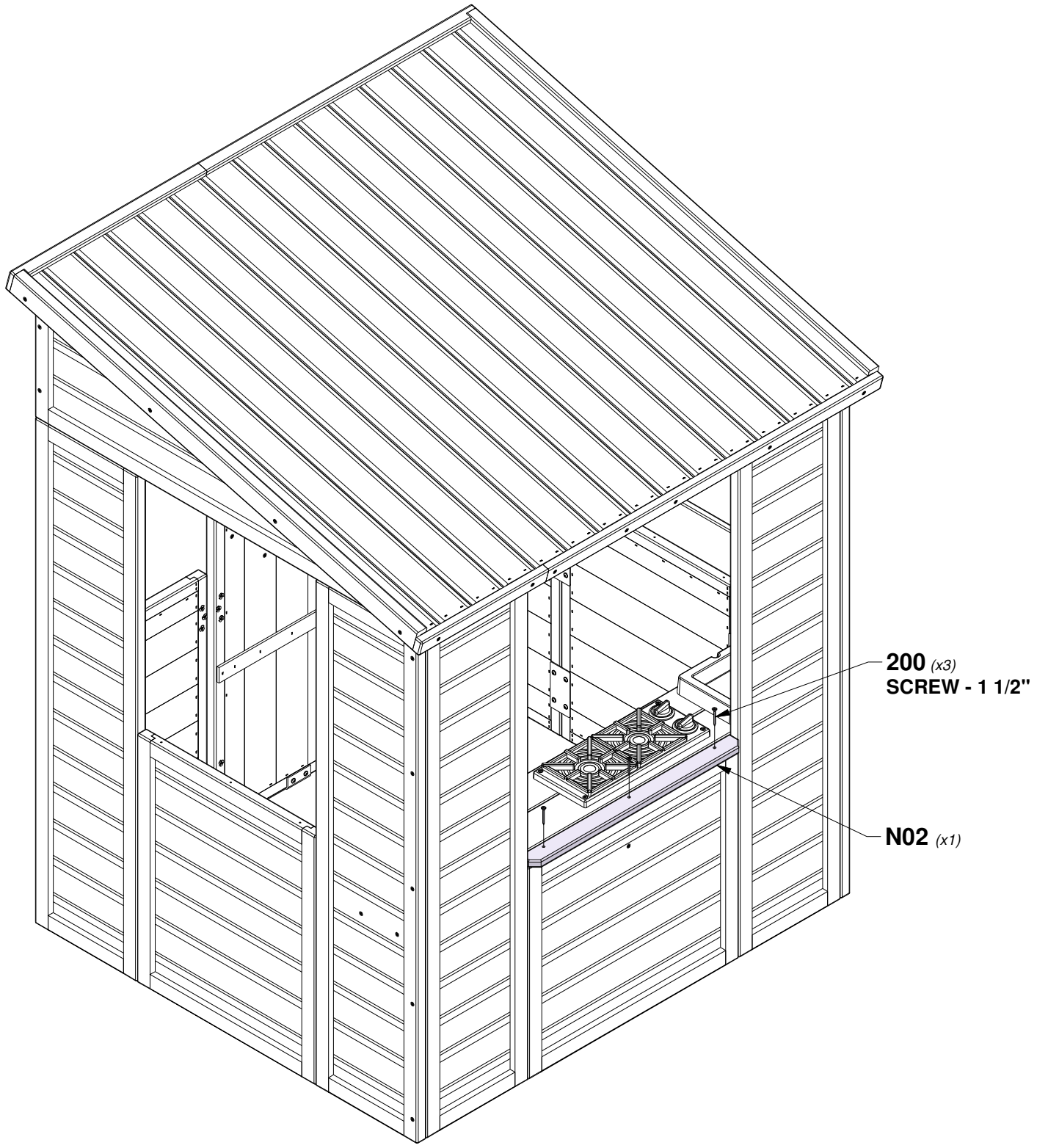

# STEP 30 - PLAYHOUSE ASSEMBLY

QTY	PART NUMBER	DESCRIPTION
3	H100200	SCREW PFH 8x1-1/2 BLK

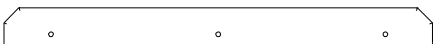

**N01 WINDOW BOARD - W4L19309**  
(x1) 5/8"x1 5/8"x17 7/8" (16x40x454)

**TIP:**  
**ALIGN PILOT HOLES**

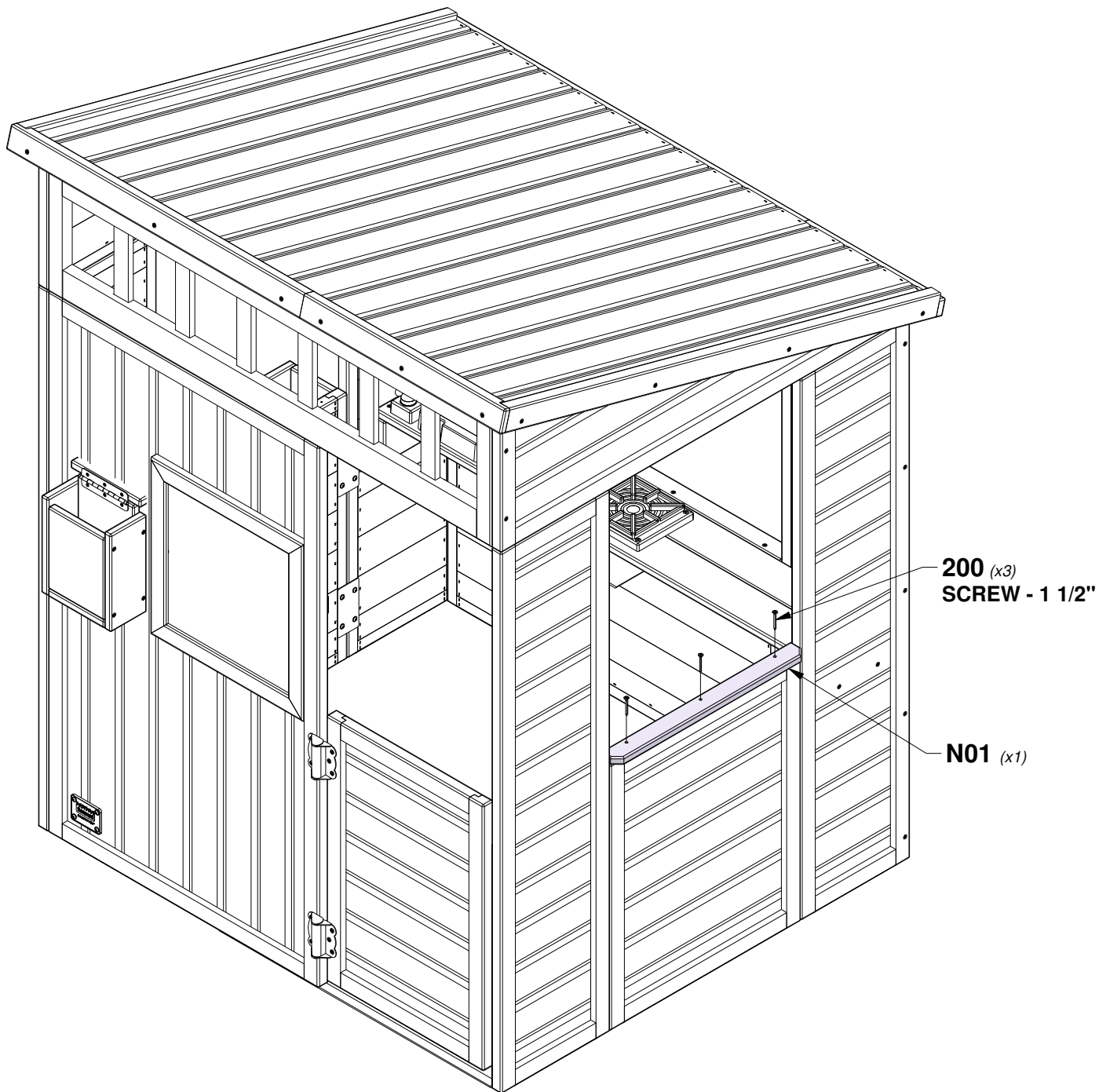

# STEP 31 - PLAYHOUSE ASSEMBLY

QTY	PART NUMBER	DESCRIPTION
3	H100200	SCREW PFH 8x1-1/2 BLK



**N01 WINDOW BOARD - W4L19309**  
(x1) 5/8"x1 5/8"x17 7/8" (16x40x454)

**TIP:**  
**ALIGN PILOT HOLES**

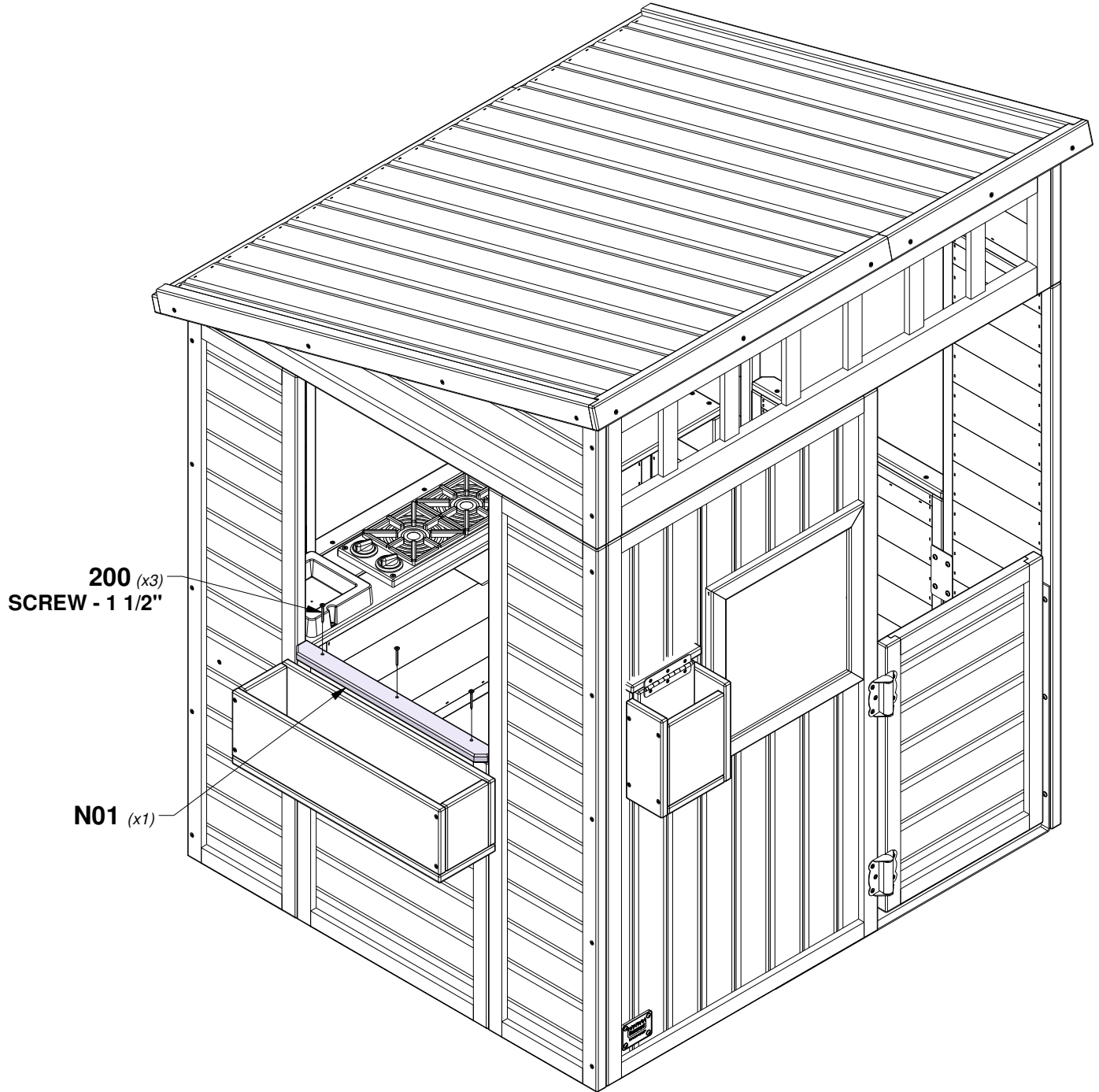

# STEP 32 - PLAYHOUSE ASSEMBLY

QTY	PART NUMBER	DESCRIPTION
4	H100192	NUT BARREL WH 5/16x7/8 BLK
4	H100199	WASHER LOCK EXT 12x19 BLK
4	H100396	BOLT WH 5/16x1/2 BLK



**NOTE:**  
TAP IN GROUND STAKES AT AN APPROXIMATE 45° ANGLE AT LOCATIONS SHOWN. USING GROUND STAKE AS A GUIDE, DRILL 3/8" [10mm] DIA HOLES FOR HARDWARE.

**TOP VIEW**

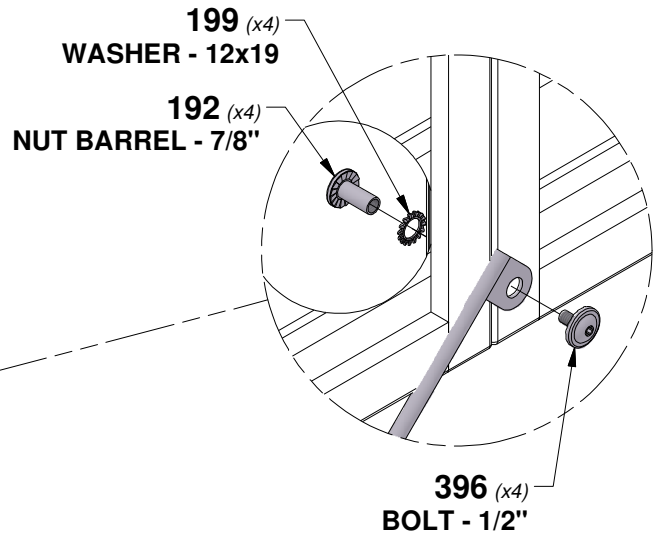
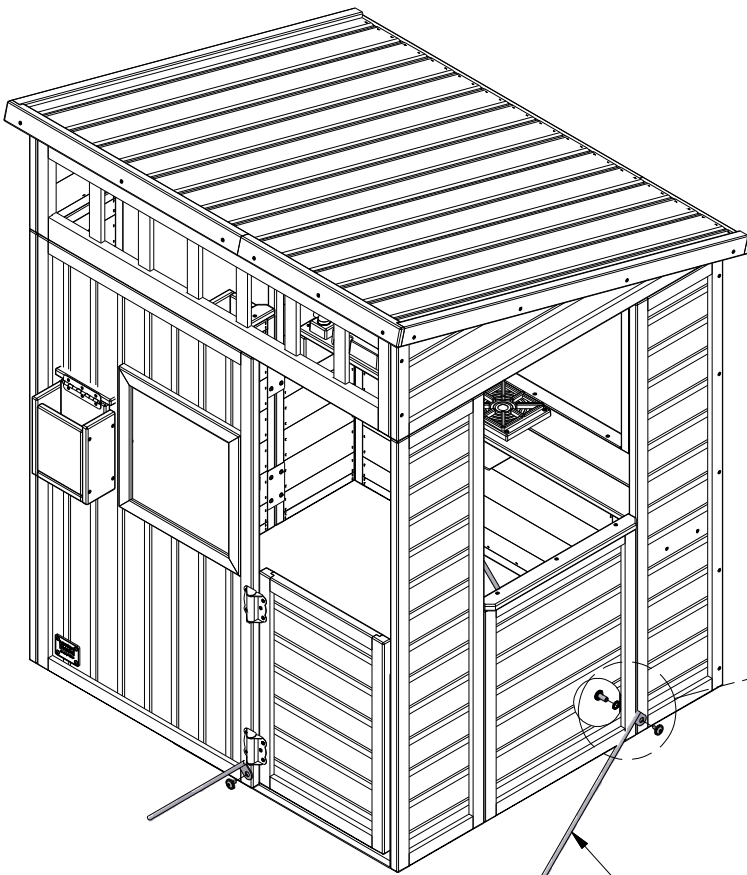
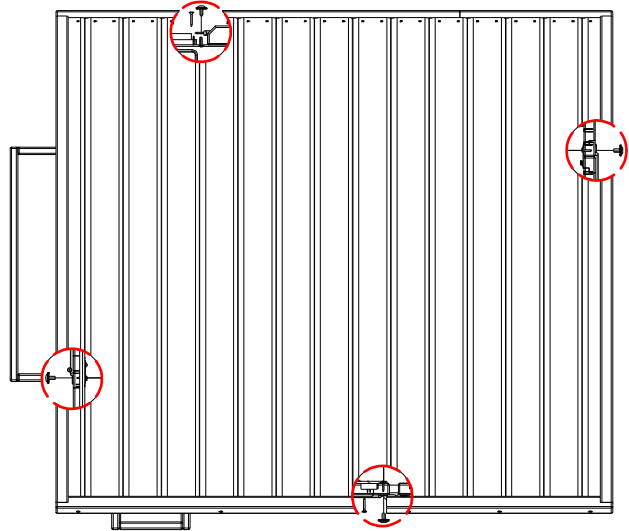

**527 (x4)**  
GROUND STAKE REBAR