



MANUFACTURED BY:
Backyard Discovery
3305 Airport Drive, Pittsburg, KS 66762
800-856-4445

Backyard Discovery Australia Pty Ltd 2/7 Hood Street, Hampton VIC 3188, Phone: 1800-087-941

CARAWAY COTTAGE - WHITE PLAYHOUSE

Model # 2503052

The assembly manual must be retained
since it contains important information



WARNING
Adult Assembly Required.
FOR DOMESTIC USE ONLY. INTENDED FOR OUTDOOR USE.

CAN ICES-003 (B)/NMB-003(B)



Please visit www.backyarddiscovery.com

For the most up to date assembly manual, to register your set, or to order replacement parts
Para obtener instrucciones en español, visite www.backyarddiscovery.com

Owner's Manual - Basic Setup Dimensions & Assembly Notes

Selecting the correct location for your play product is important for your children's safety and the product's longevity

- The safe play area refers to a zone extending 6'-7" (2007m) beyond the play product on all sides, including the space above the play product.

SAFE PLAY AREA DIAGRAM

Ground Dimension

3'-7 1/4" [1096 mm] x 4'-2 1/4" [1276 mm]

Safe Play Area

16'-9 1/4" [5110 mm] x 17'-4 1/4" [5290 mm] x 11'-4" [3454 m]

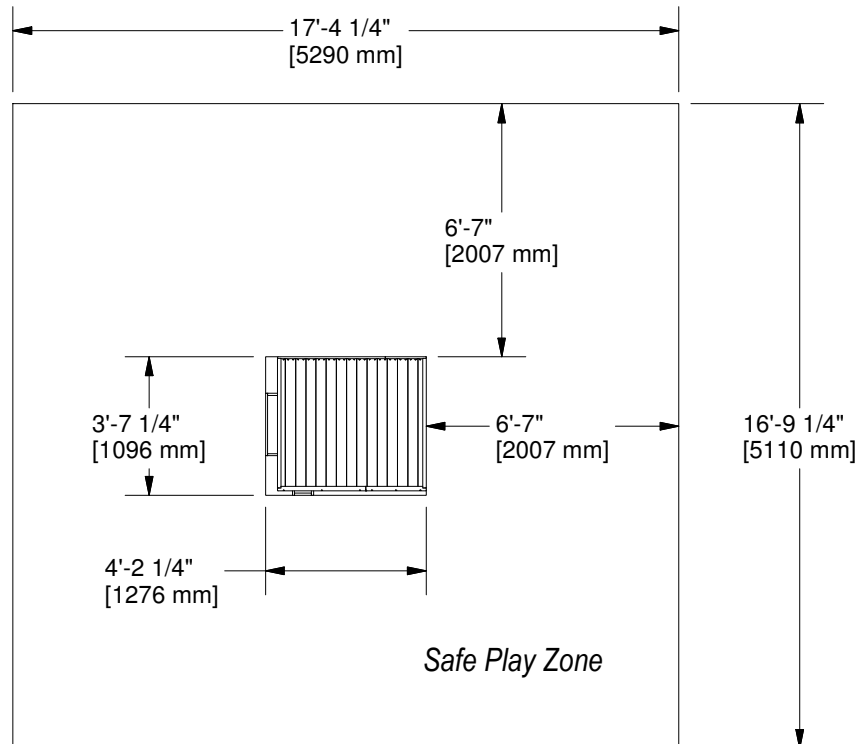

SAFE PLAY HEIGHT: 11'-4" [3454 mm]
MAXIMUM FALL HEIGHT: 1'-10 3/4" [578 mm]

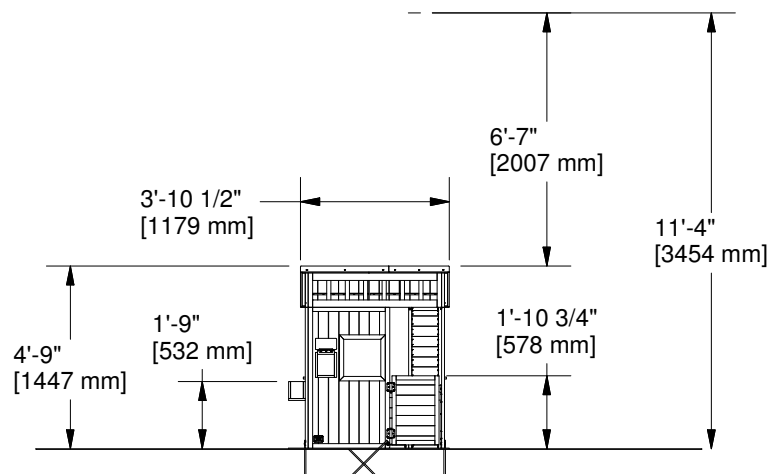

General Information:

Your set has been designed and engineered for children only and for residential use only.
A maximum of 150 lbs. per child is recommended for play activities designed for individual use.
A maximum of 120 lbs. per child is recommended for play activities designed for multiple child use.
A maximum of 6 children is recommended for this playhouse.

Owner's Manual - Parts Identification

Wood Components (Not to Scale)

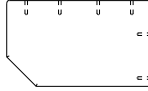

AD01 TABLE TOP SUPPORT - W4L19818

(x1) 1"x4"x6 3/4" (24x102x172)



F01 ROOF TRIM - W4L19315

(x2) 1"x1 7/8"x41 7/8" (26x47x1064)

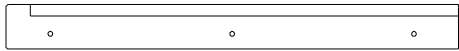

F03 ROOF TRIM - W4L19820

(x1) 1"x1 7/8"x18 7/8" (26x47x479)

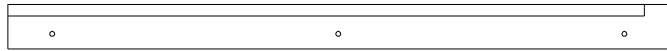

F02 ROOF TRIM - W4L19316

(x1) 1"x1 7/8"x27 1/2" (26x47x700)

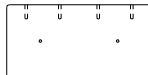

H01 TABLE TOP SUPPORT - W4L19817

(x2) 1"x3 3/8"x6 3/4" (24x86x172)



J01 TOP RAIL - W4L19308

(x1) 1"x1 3/8"x41 5/8" (24x34x1057)



K01 FRONT - W4L19311

(x1) 5/8"x5 1/4"x19 1/2" (16x134x495)



K02 BACK - W4L19312

(x1) 5/8"x5 1/4"x19 1/2" (16x134x495)

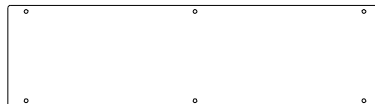

K03 BOTTOM - W4L19314

(x1) 5/8"x5 1/4"x19 1/2" (16x134x495)

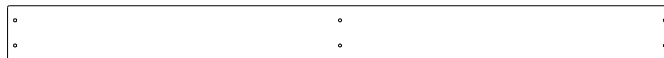

M02 TABLE TOP - W4L19816

(x2) 5/8"x3 3/8"x41 5/8" (16x86x1056)



N01 WINDOW BOARD - W4L19309

(x2) 5/8"x1 5/8"x17 7/8" (16x40x454)

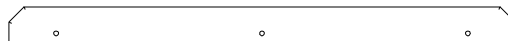

N02 WINDOW BOARD - W4L19310

(x1) 5/8"x1 5/8"x21 1/8" (16x40x536)



N04 ROOF TRIM - W4L19819

(x1) 5/8"x1 3/8"x12 3/4" (16x34x324)



N03 ROOF TRIM - W4L19317

(x1) 5/8"x1 3/8"x33 5/8" (16x34x855)



Y01 SIDE - W4L19313

(x2) 5/8"x4"x5 1/4" (16x102x134)

Owner's Manual - Parts Identification

Wood Components (Not to Scale)

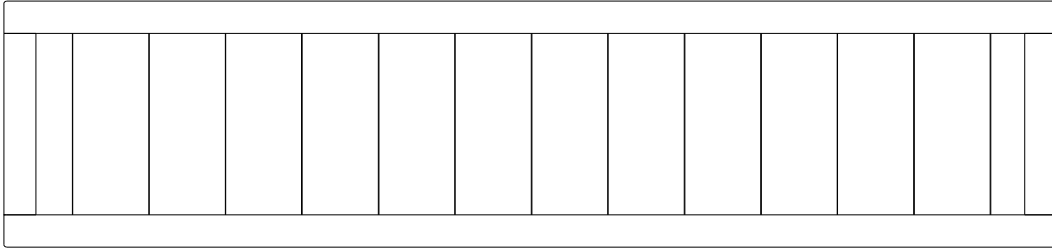

WP01 WALL PANEL - W2A04117
(x1) 1"x10 1/4"x43 7/8" (24x260x1115)

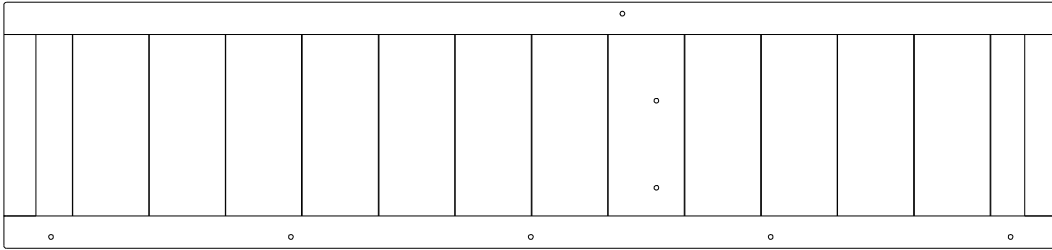

WP02 WALL PANEL - W2A04118
(x1) 1"x10 1/4"x43 7/8" (24x260x1115)

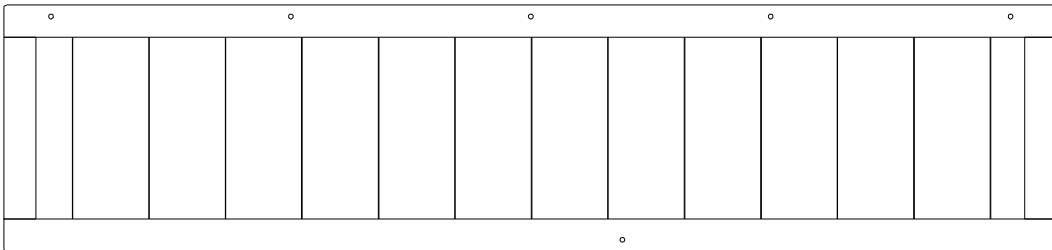

WP03 WALL PANEL - W2A04119
(x1) 1"x10 1/4"x43 7/8" (24x260x1115)

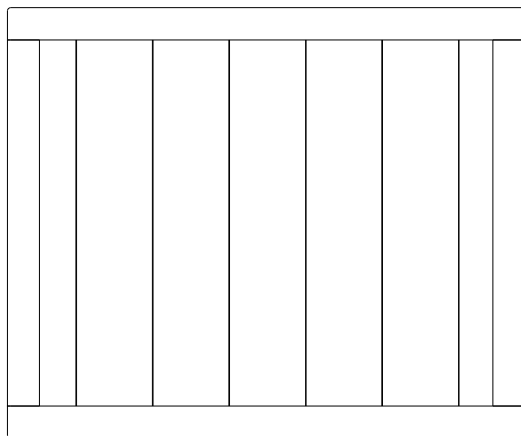

WP04 WALL PANEL - W2A04120
(x2) 1"x10 1/4"x43 7/8" (24x455x548)

Owner's Manual - Parts Identification

Wood Components (Not to Scale)

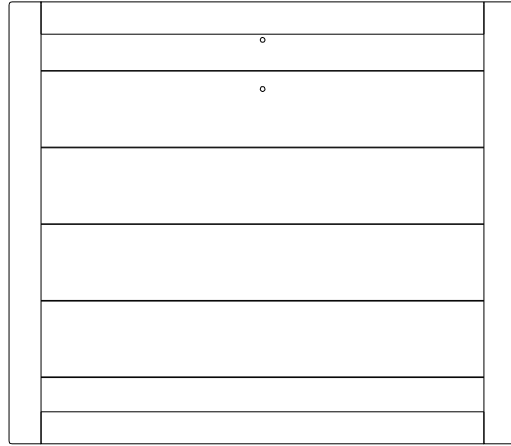

WP05 WALL PANEL - W2A04121
(x1) 1"x18 3/8"x21 1/8" (24x467x537)

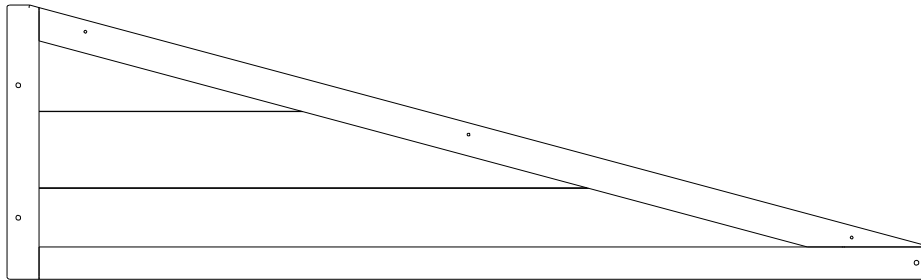

WP06 WALL PANEL - W2A04122
(x1) 1"x11 3/8"x38 3/8" (24x290x975)

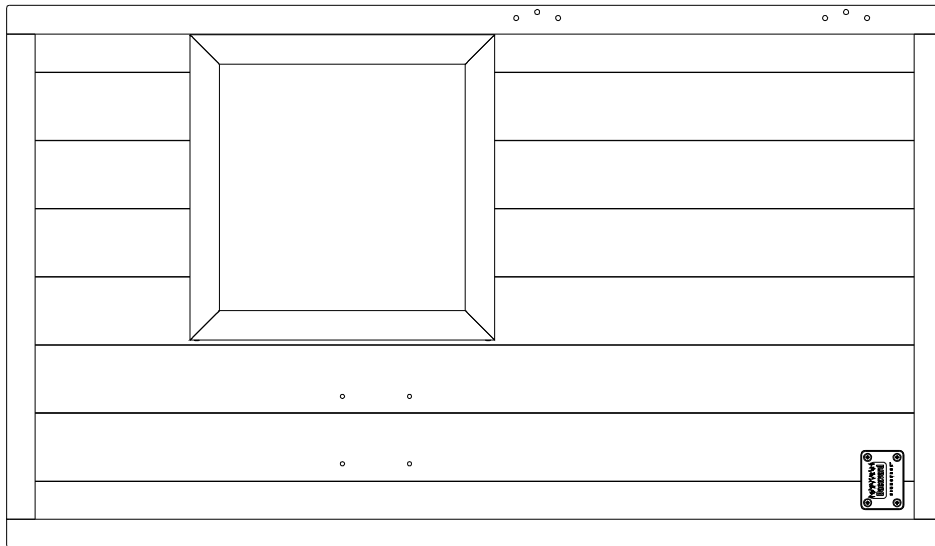

WP07 WALL PANEL - W2A04123
(x1) 1"x10 1/4"x43 7/8" (24x645x1115)

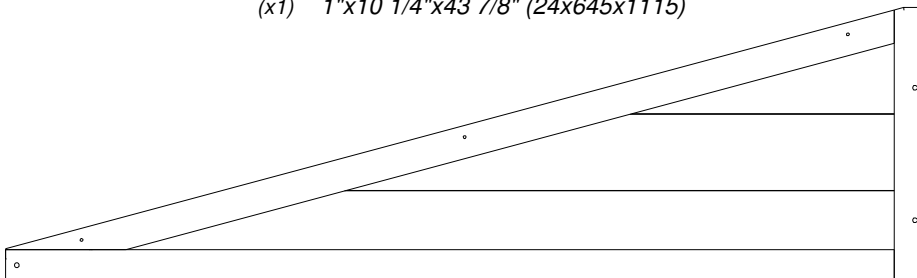

WP08 WALL PANEL - W2A04124
(x1) 1"x11 3/8"x38 3/8" (24x290x975)

Owner's Manual - Parts Identification

Wood Components (Not to Scale)

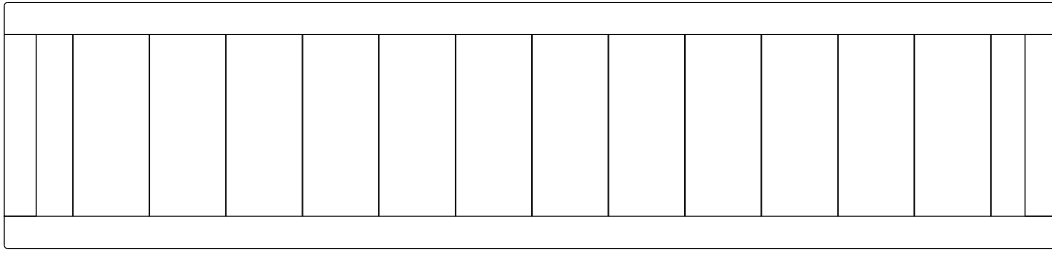

WP09 WALL PANEL - W2A04126
(x1) 1"x10 1/4"x43 7/8" (24x260x1115)

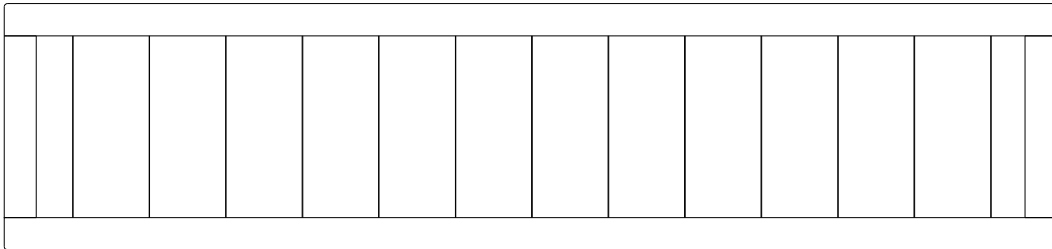

WP10 WALL PANEL - W2A04127
(x1) 1"x10 1/4"x43 7/8" (24x260x1115)

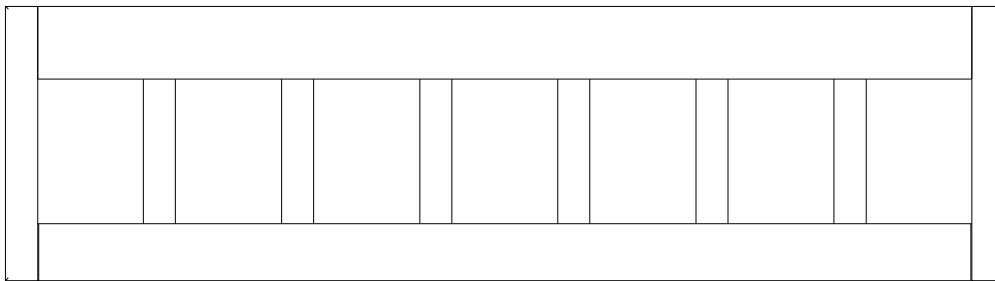

WP11 WALL PANEL - W2A04128
(x1) 15/16"x11 7/16"x41 5/8" (24x290x1057)

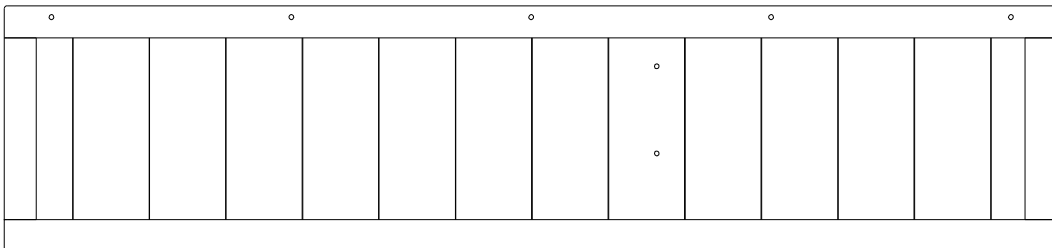

WP12 WALL PANEL - W2A04132
(x1) 1"x10 1/4"x43 7/8" (24x260x1115)

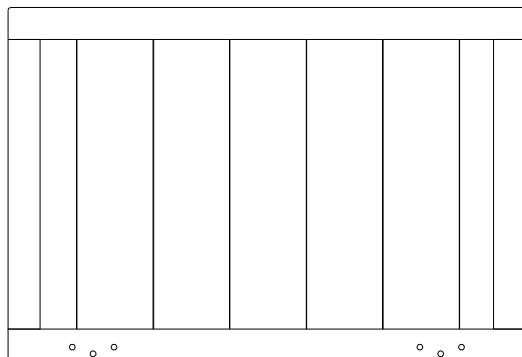

DP01 DOOR PANEL - W2A04125
(x1) 1"x10 1/4"x43 7/8" (24x374x548)

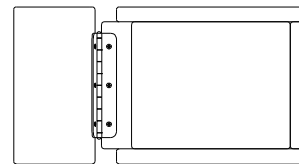

MB01 MAILBOX - W2A04129
(x1) 3 3/8"x6 9/16"x8 3/4" (86x166x222)

Owner's Manual - Parts Identification

Wood Components (Not to Scale)

RP01 ROOF PANEL - W2A04130
(x1) 1 3/8"x24 5/8"x41 7/8" (35x625x1064)

RP02 ROOF PANEL - W2A04131
(x1) 1 3/8"x21 1/8"x41 7/8" (35x535x1064)

Owner's Manual - Parts Identification

Hardware Components

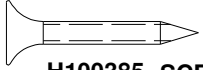

H100385 SCREW PFH BLK
(x4) 8x1

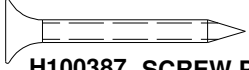

H100387 SCREW PFH BLK
(x25) 8x1 1/4

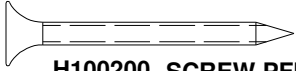

H100200 SCREW PFH BLK
(x39) 8x1 1/2

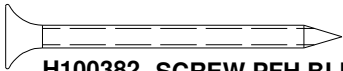

H100382 SCREW PFH BLK
(x6) 8x1 3/4

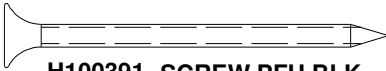

H100391 SCREW PFH BLK
(x23) 8x2

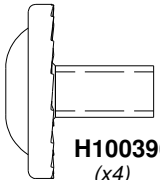

H100396 BOLT WH BLK
(x4) 5/16x1/2

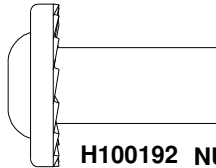

H100192 NUT BARREL WH BLK
(x4) 5/16x7/8

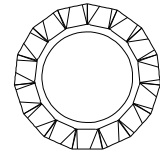

H100199 WASHER LOCK EXT BLK
(x4) 12x19

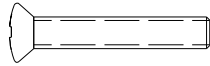

H100807 SCREW POH BLK
(x12) 8/32x1



H100804 T-NUT
(x12) 8/32

Owner's Manual - Parts Identification

Accessory Components (Not to Scale)

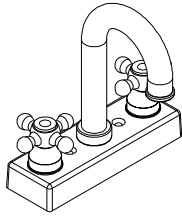

A6P00024 FAUCET KIT
(x1)

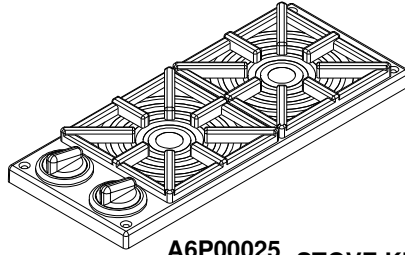

A6P00025 STOVE KIT
(x1)

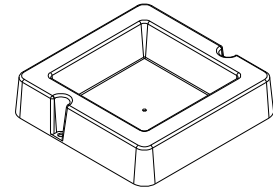

A6P00032 SURFACE MOUNT BASIN
(x1)



A6P00336 BOIL POT
(x1)



A6P00338 FRY PAN
(x1)



A6P00337 POT/PAN LID
(x1)

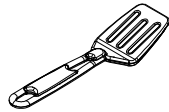

A6P00339 SPATULA
(x1)

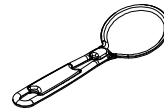

A6P00340 LADLE
(x1)

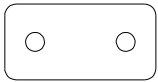

A4M02752 CLEAT
(x8)



A4M00624 HINGE (DOOR, SPRING LOADED)
(x1)

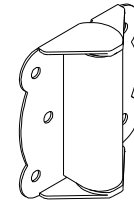

A4M00994 HINGE (DOOR, NON-SPRING LOADED)
(x1)

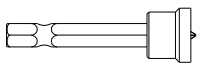

H100764 SCREW SETTER
(x1)

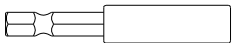

H101100 MAGNETIC DRIVER
(x1)

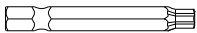

H100147 T-30 TORX BIT
(x1)

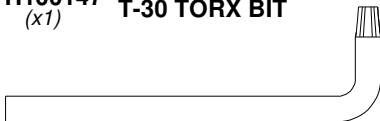

H100114 T-30 TORX WRENCH
(x1)



A4M00527 GROUND STAKE REBAR
(x4)

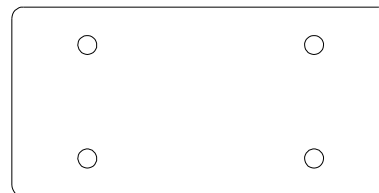

A4M02100 CLEAT
(x12)



A4M02754 METAL TIE STRAP
(x1)

PRE-ASSEMBLY STEP 1 - SORTING PARTS

It is critical for ease of assembly that you take the time to sort and organize the wood and hardware.

WOOD PARTS:

- Organize wood parts by the three-digit, alpha-numeric number stamped on each board (ex. P01).
- If there are multiple boards with the same stamped number, stack those pieces together.
- Stamps can be found on the flat surface of the boards or on the end of the boards.
- Allow yourself plenty of room - the wood pieces can take up a significant amount of space.

NOTE: CARTONS ARE NOT ORGANIZED BY BOARD NUMBER.

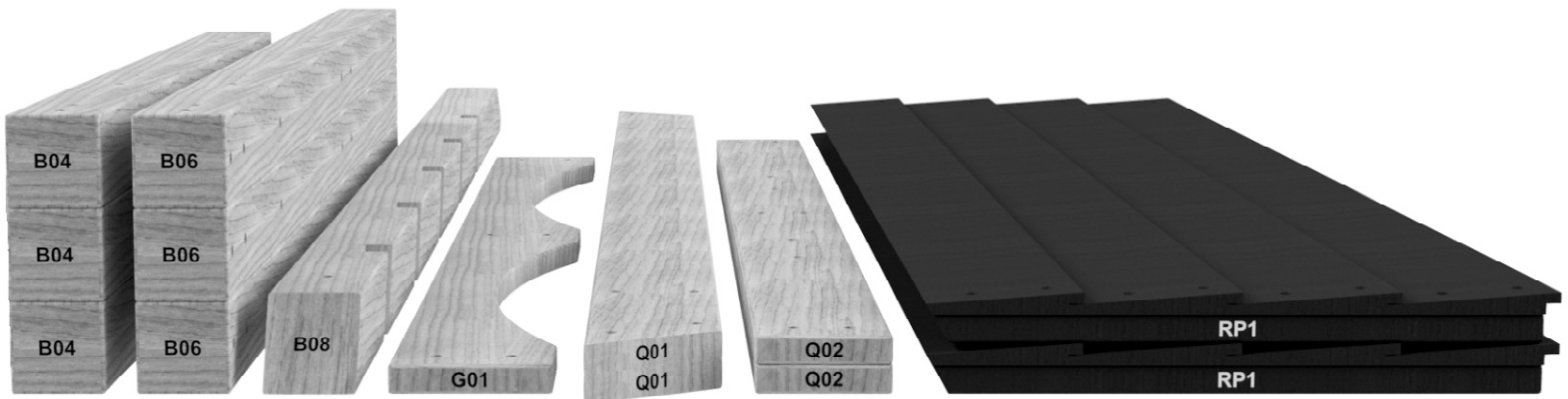

HARDWARE PARTS:

- We recommend that you have a separate table to organize the hardware.
- Hardware bags are printed with a seven-digit, alpha-numeric part number.
- You can organize your hardware by part number or group by hardware type (i.e. bolts, nuts, etc.).
- During assembly you only need to reference the last four digits of the number.



PRE-ASSEMBLY STEP 2 - TOOLS REQUIRED



Cordless Drill or
Electric Drill

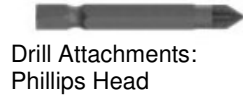

Drill Attachments:
Phillips Head



1/8", 3/16", 3/8" & 7/16" Drill Bits



Phillips Screw Driver



Open End Wrenches 1/2" & 9/16"



3/8" Drive Ratchet, 1/2" &
9/16" STD Sockets 1/2" & 9/16" Deep Sockets



Claw Hammer



Rubber Mallet - Optional

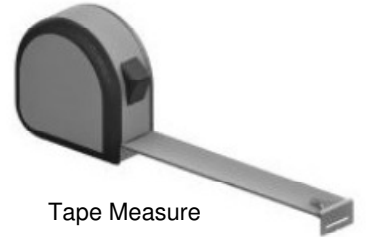

Tape Measure

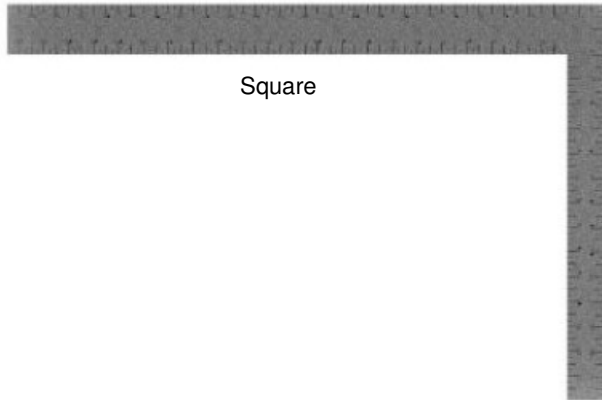

Square



Level 24"

STEP 1 - BOX ASSEMBLY

QTY	PART NUMBER	DESCRIPTION
4	H100200	SCREW PFH 8x1-1/2 BLK



K01 FRONT - W4L19311
(x1) 5/8"x5 1/4"x19 1/2" (16x134x495)

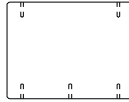

Y01 SIDE - W4L19313
(x2) 5/8"x4"x5 1/4" (16x102x134)

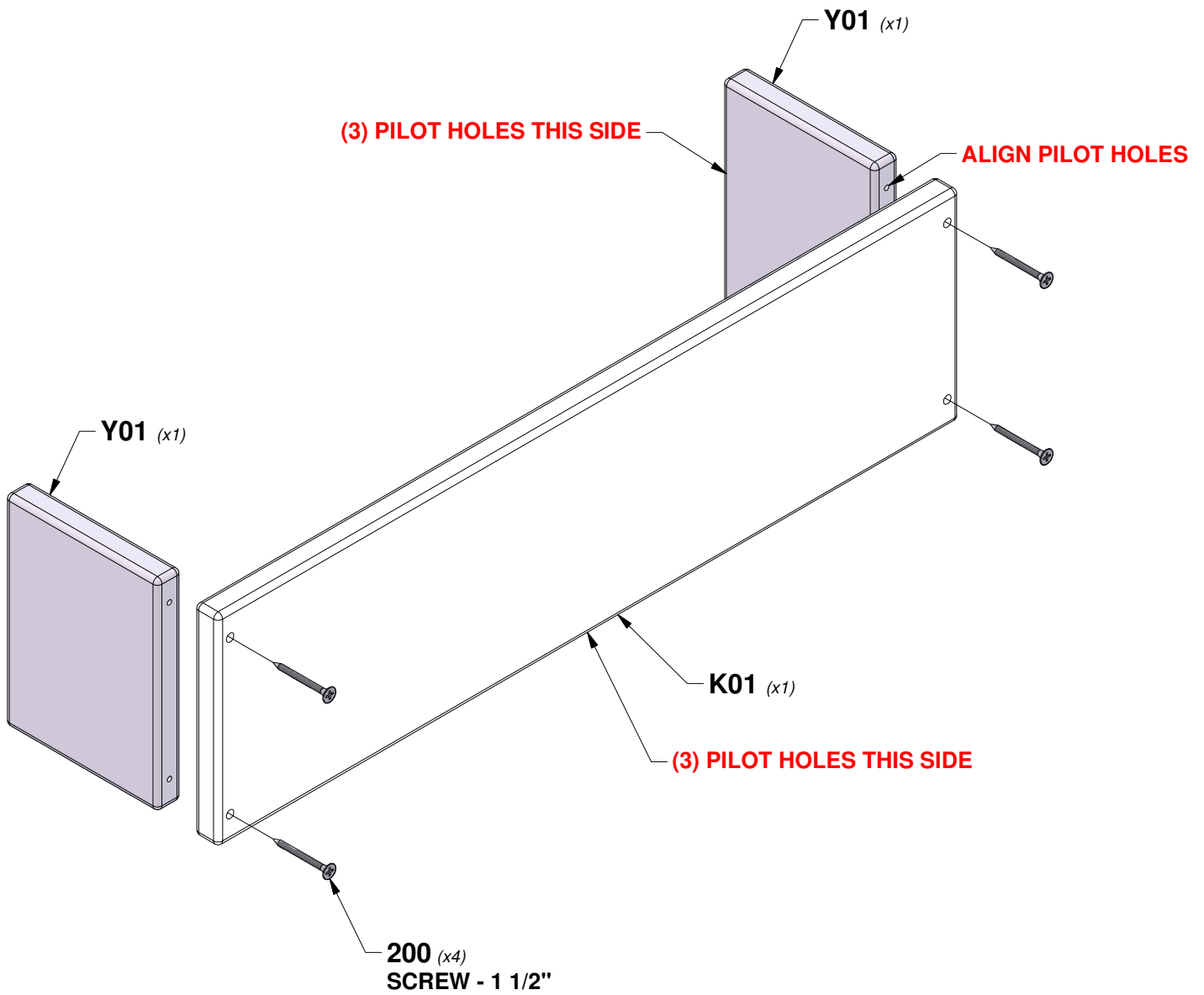

STEP 2 - BOX ASSEMBLY

QTY	PART NUMBER	DESCRIPTION
4	H100200	SCREW PFH 8x1-1/2 BLK

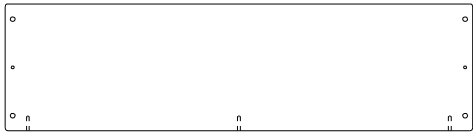

K02 BACK - W4L19312
(x1) 5/8"x5 1/4"x19 1/2" (16x134x495)

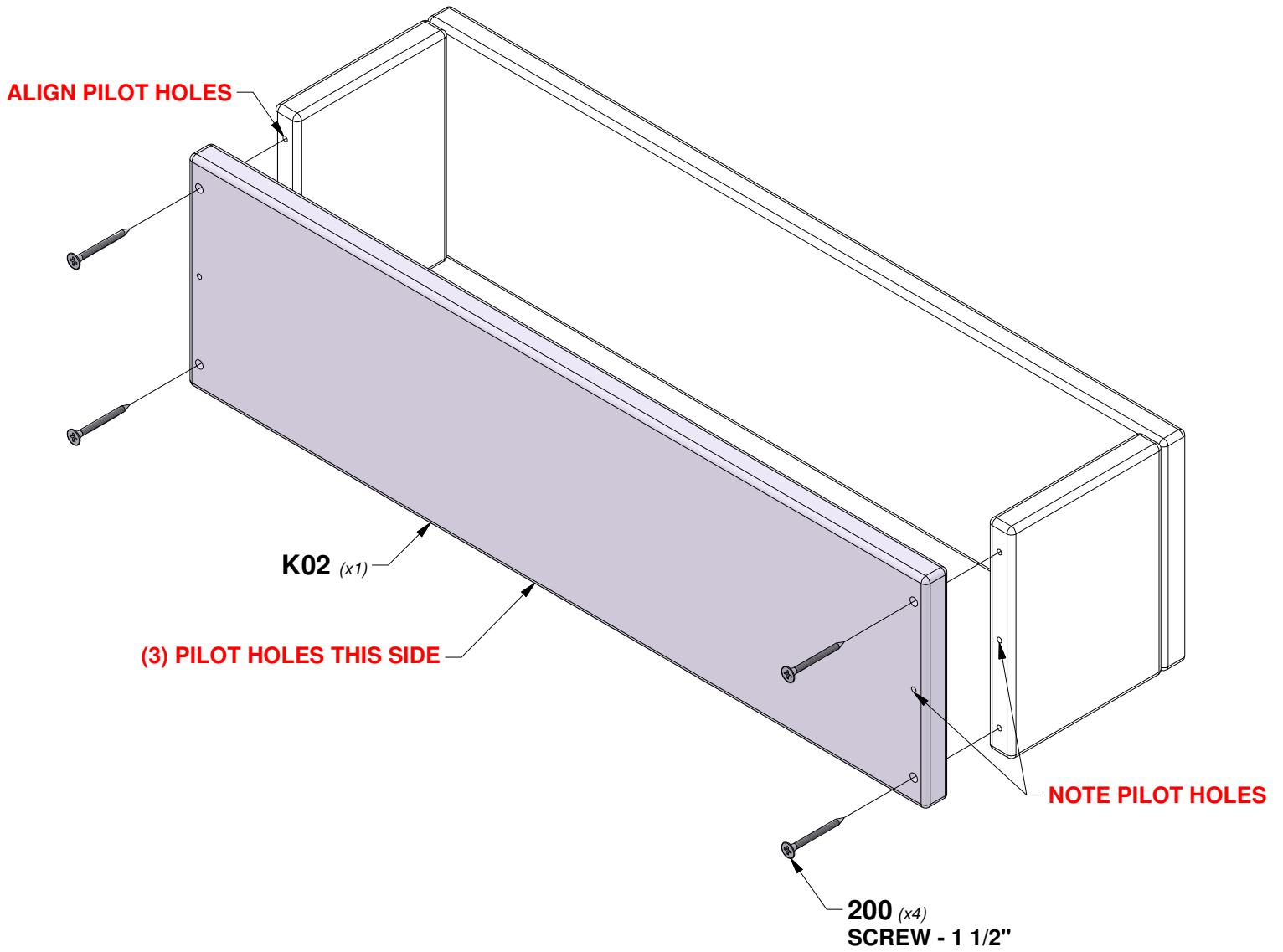

STEP 3 - BOX ASSEMBLY

QTY	PART NUMBER	DESCRIPTION
6	H100200	SCREW PFH 8x1-1/2 BLK



K03 BOTTOM - W4L19314
(x1) 5/8"x5 1/4"x19 1/2" (16x134x495)

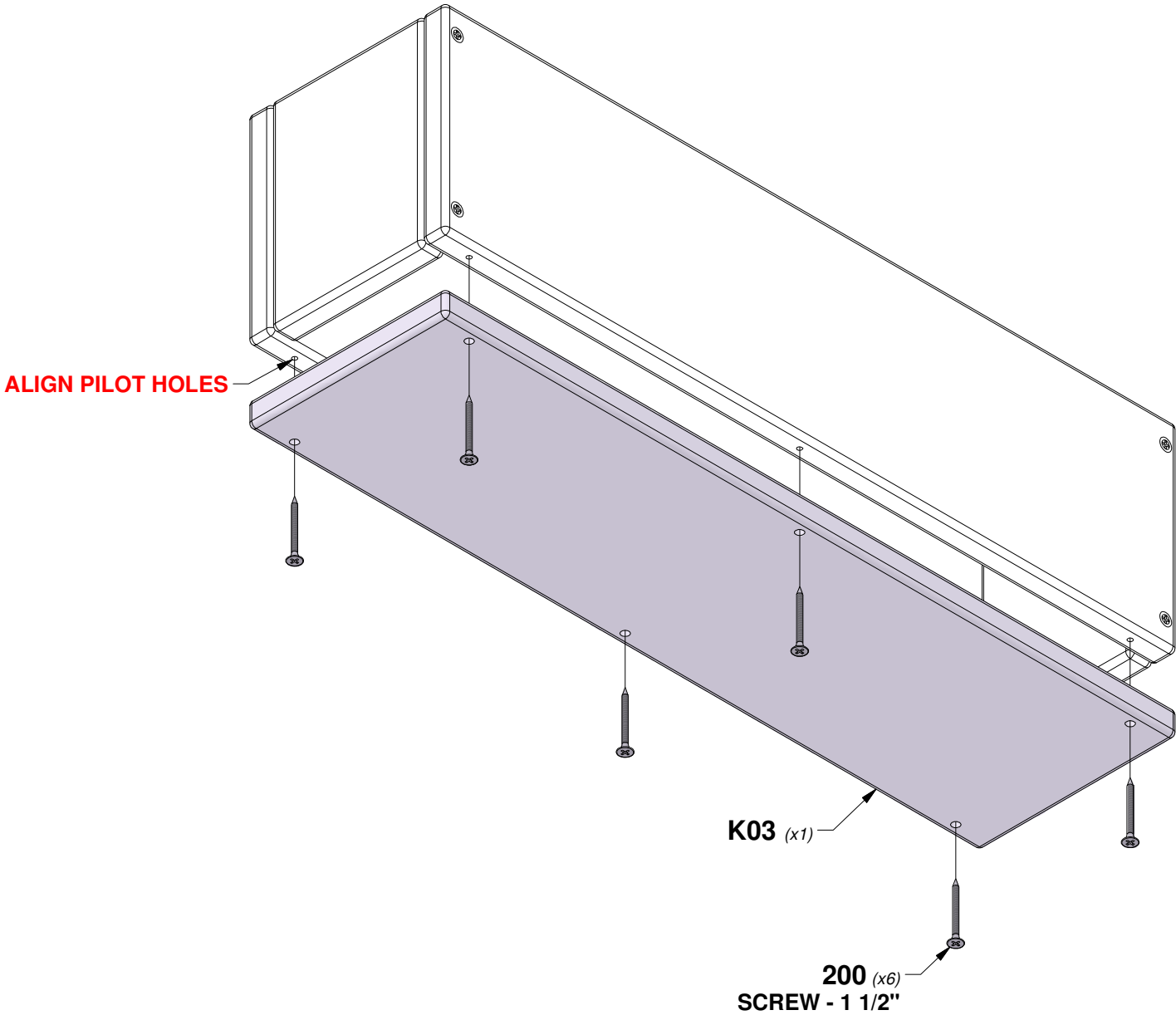

STEP 1 - PLAYHOUSE ASSEMBLY

QTY	PART NUMBER	DESCRIPTION
5	H100391	SCREW PFH 8x2 BLK

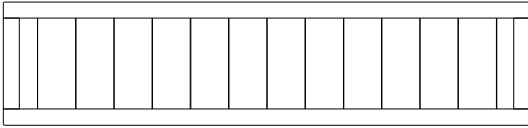

WP01 WALL PANEL - W2A04117
(x1) 1"x10 1/4"x43 7/8" (24x260x1115)

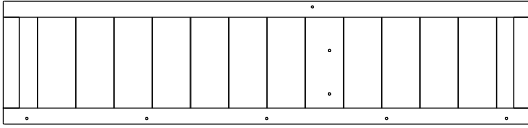

WP02 WALL PANEL - W2A04118
(x1) 1"x10 1/4"x43 7/8" (24x260x1115)

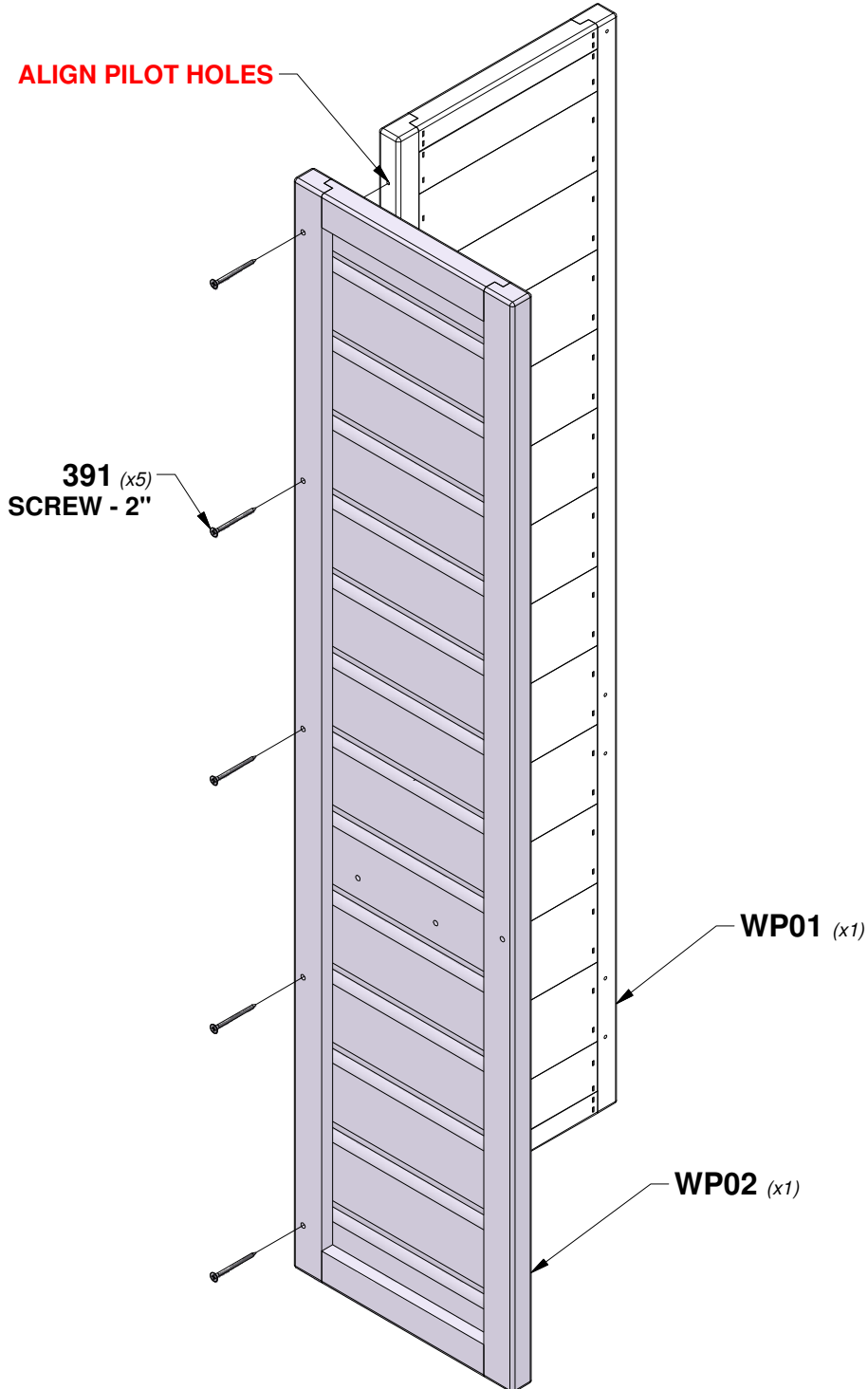

STEP 2 - PLAYHOUSE ASSEMBLY

QTY	PART NUMBER	DESCRIPTION
8	H100392	SCREW PWH 8x3/4 BLK

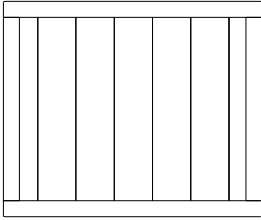

WP04 WALL PANEL - W2A04120
 (x1) 1"x10 1/4"x43 7/8" (24x455x548)



A4M02100 CLEAT
 (x2)

TIP:
ALIGN PILOT HOLES

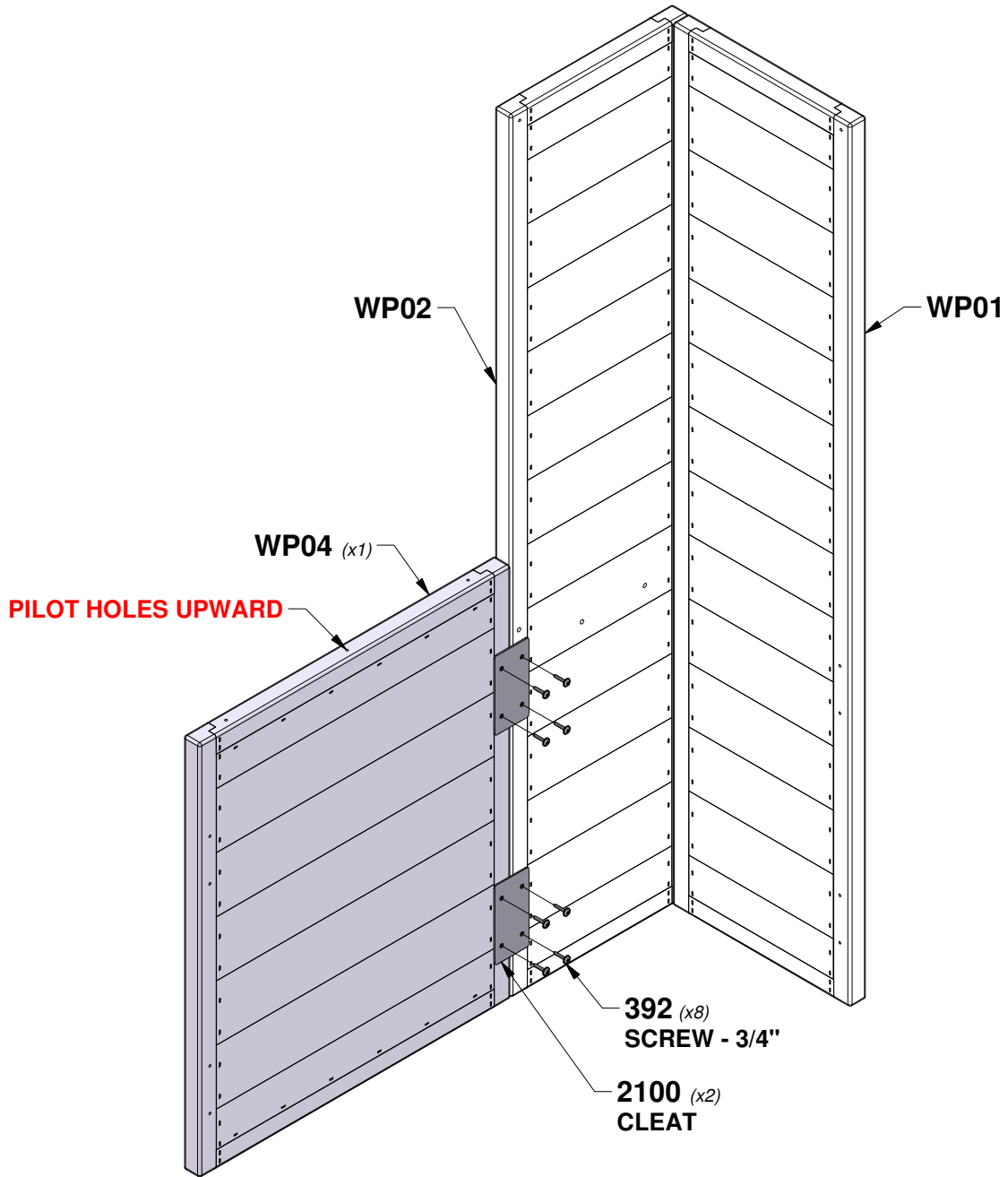

STEP 3 - PLAYHOUSE ASSEMBLY

QTY	PART NUMBER	DESCRIPTION
8	H100392	SCREW PWH 8x3/4 BLK

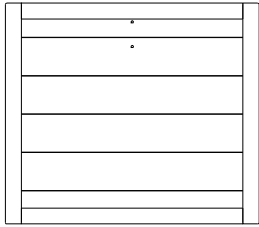

WP05 WALL PANEL - W2A04121
(x1) 1"x18 3/8"x21 1/8" (24x467x537)



A4M02100 CLEAT
(x2)

TIP:
ALIGN PILOT HOLES

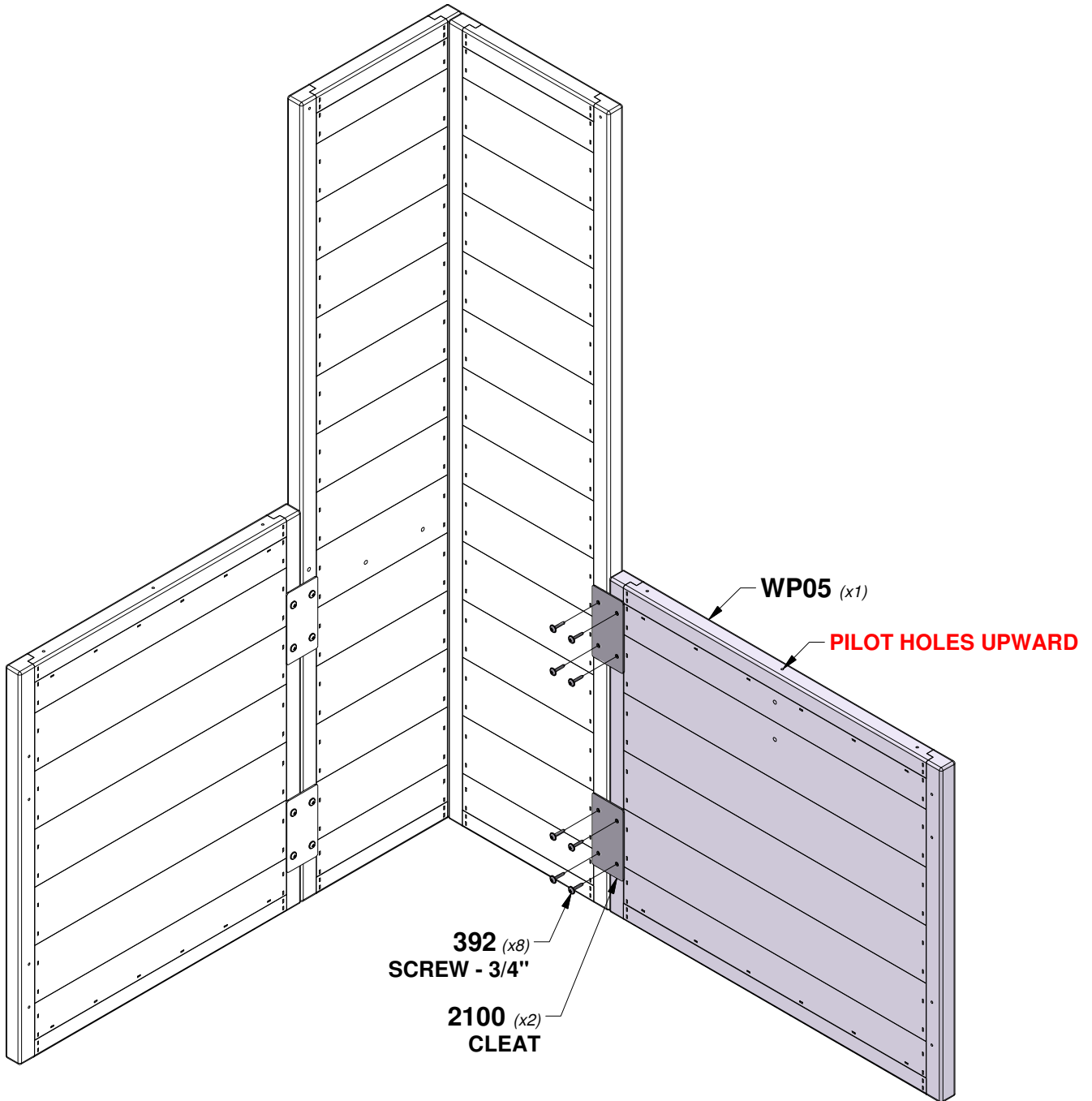

STEP 4 - PLAYHOUSE ASSEMBLY

QTY	PART NUMBER	DESCRIPTION
8	H100392	SCREW PWH 8x3/4 BLK

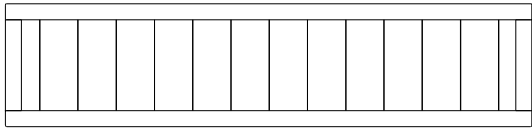

WP09 WALL PANEL - W2A04126
 (x1) 1"x10 1/4"x43 7/8" (24x260x1115)

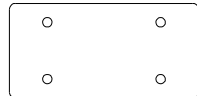

A4M02100 CLEAT
 (x2)

TIP:
ALIGN PILOT HOLES

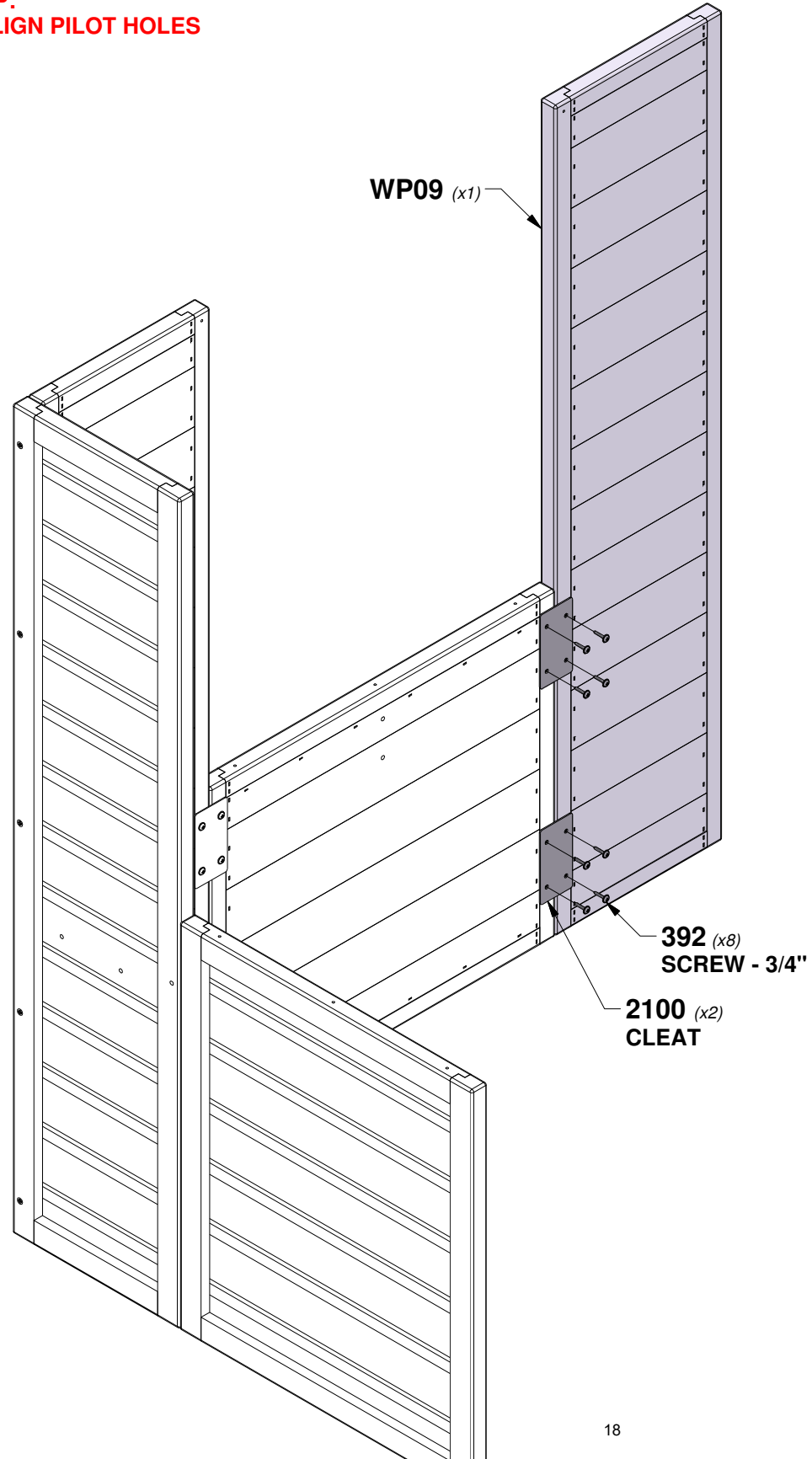

STEP 5 - PLAYHOUSE ASSEMBLY

QTY	PART NUMBER	DESCRIPTION
5	H100391	SCREW PFH 8x2 BLK

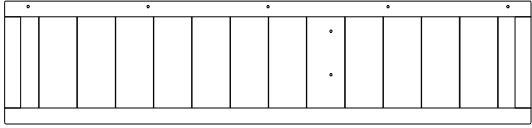

WP12 WALL PANEL - W2A04132
(x1) 1"x10 1/4"x43 7/8" (24x260x1115)

TIP:
ALIGN PILOT HOLES

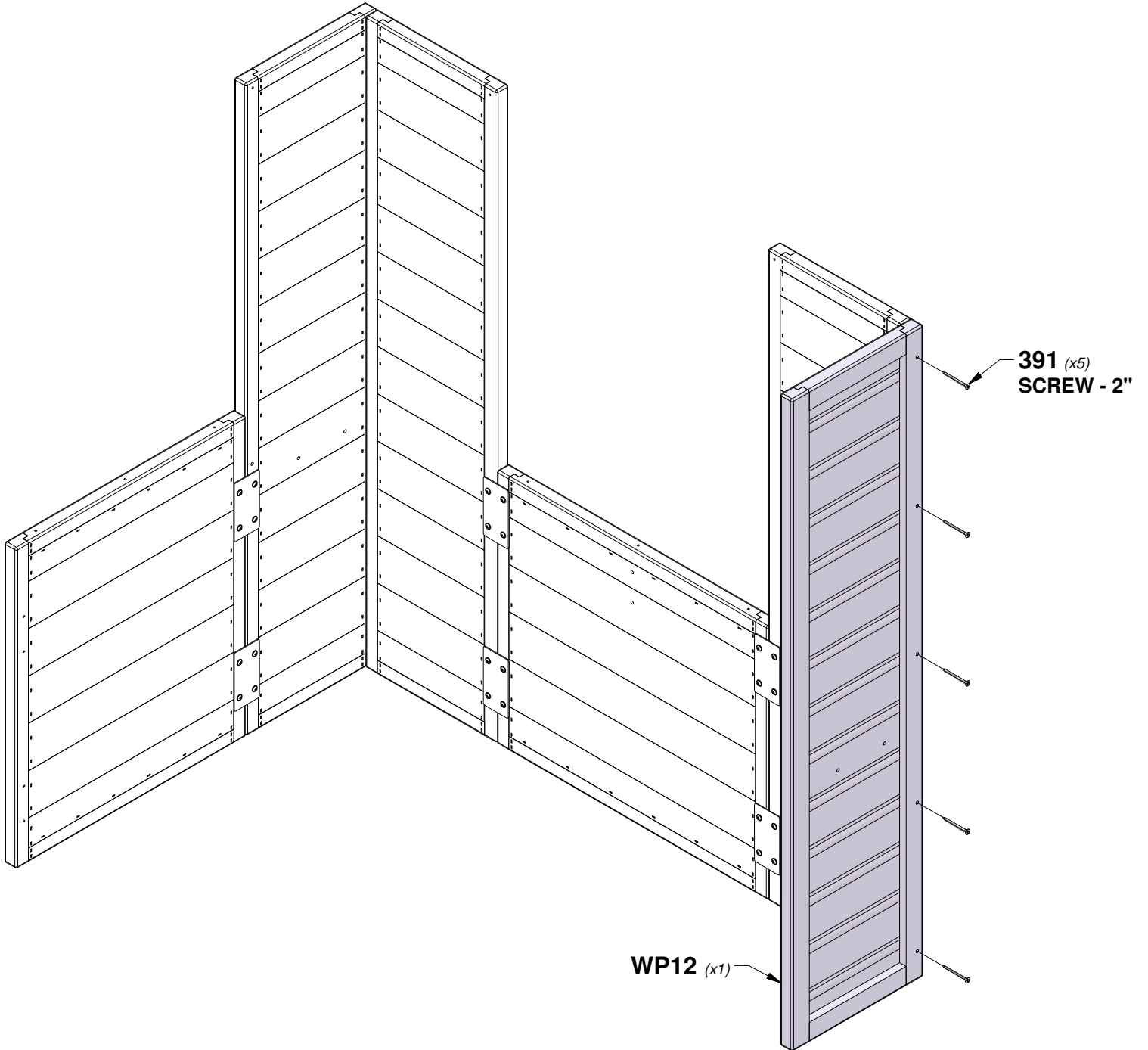

STEP 6 - PLAYHOUSE ASSEMBLY

QTY	PART NUMBER	DESCRIPTION
8	H100392	SCREW PWH 8x3/4 BLK

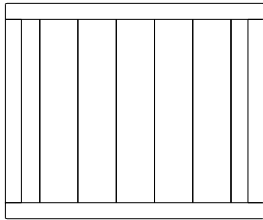

WP04 WALL PANEL - W2A04120
(x1) 1"x10 1/4"x43 7/8" (24x455x548)



A4M02100 CLEAT
(x2)

TIP:
ALIGN PILOT HOLES

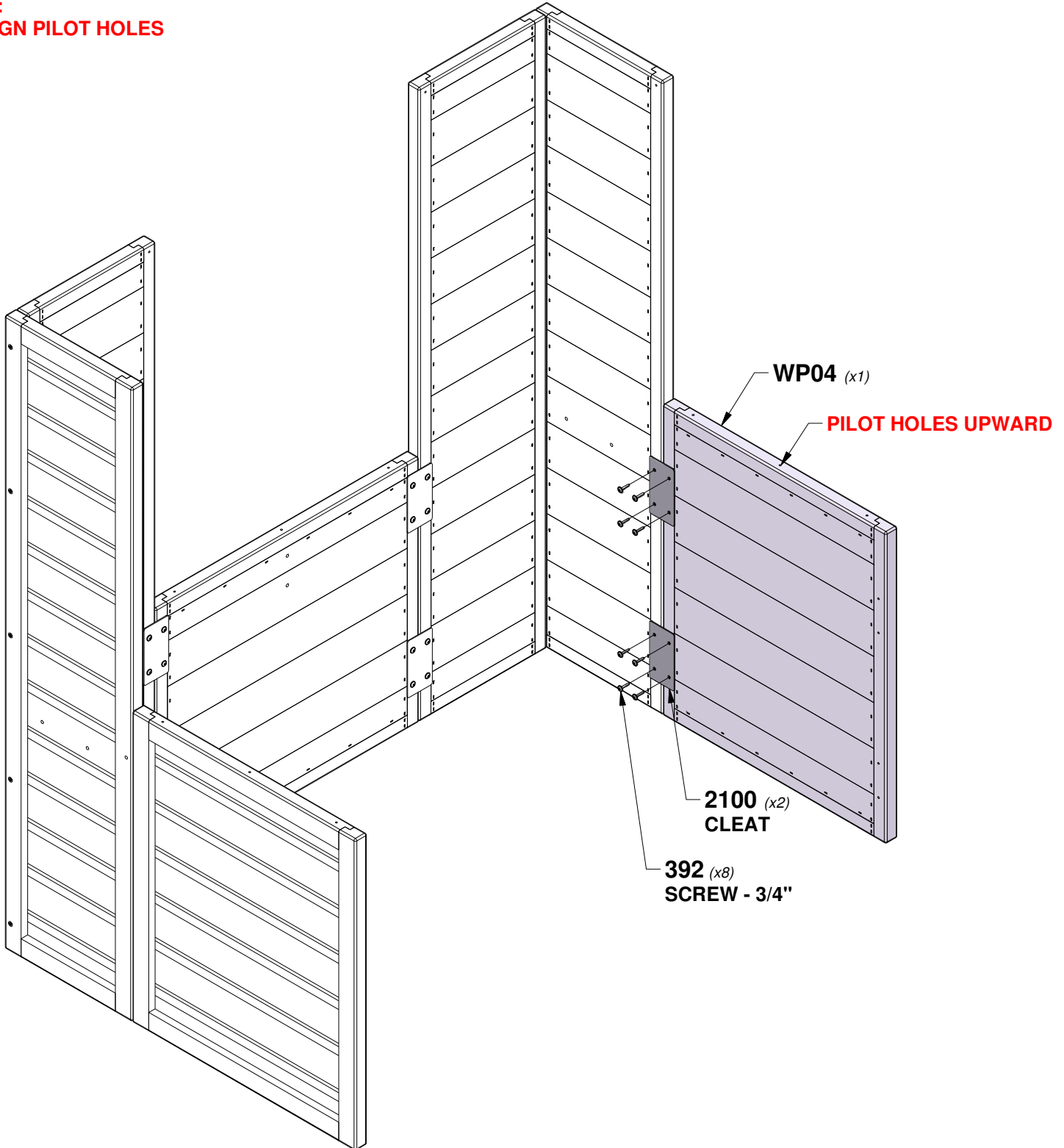

STEP 7 - PLAYHOUSE ASSEMBLY

QTY	PART NUMBER	DESCRIPTION
8	H100392	SCREW PWH 8x3/4 BLK

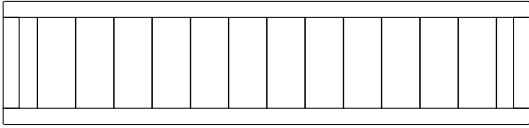

WP10 WALL PANEL - W2A04127
 (x1) 1"x10 1/4"x43 7/8" (24x260x1115)



A4M02100 CLEAT
 (x2)

TIP:
ALIGN PILOT HOLES

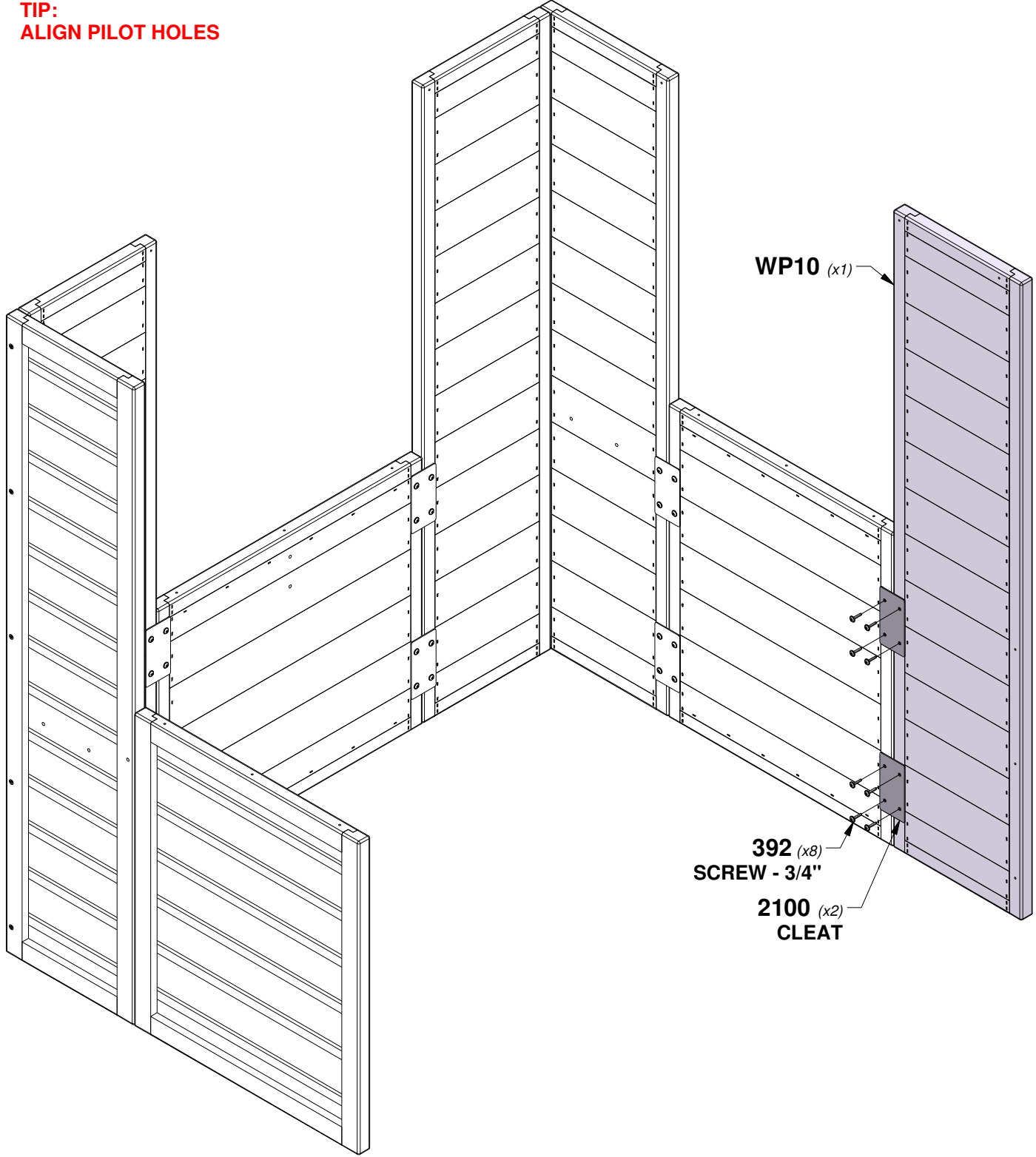

STEP 8 - PLAYHOUSE ASSEMBLY

QTY	PART NUMBER	DESCRIPTION
8	H100392	SCREW PWH 8x3/4 BLK

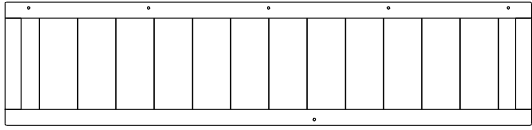

WP03 WALL PANEL - W2A04119
 (x1) 1"x10 1/4"x43 7/8" (24x260x1115)



A4M02100 CLEAT
 (x2)

TIP:
ALIGN PILOT HOLES

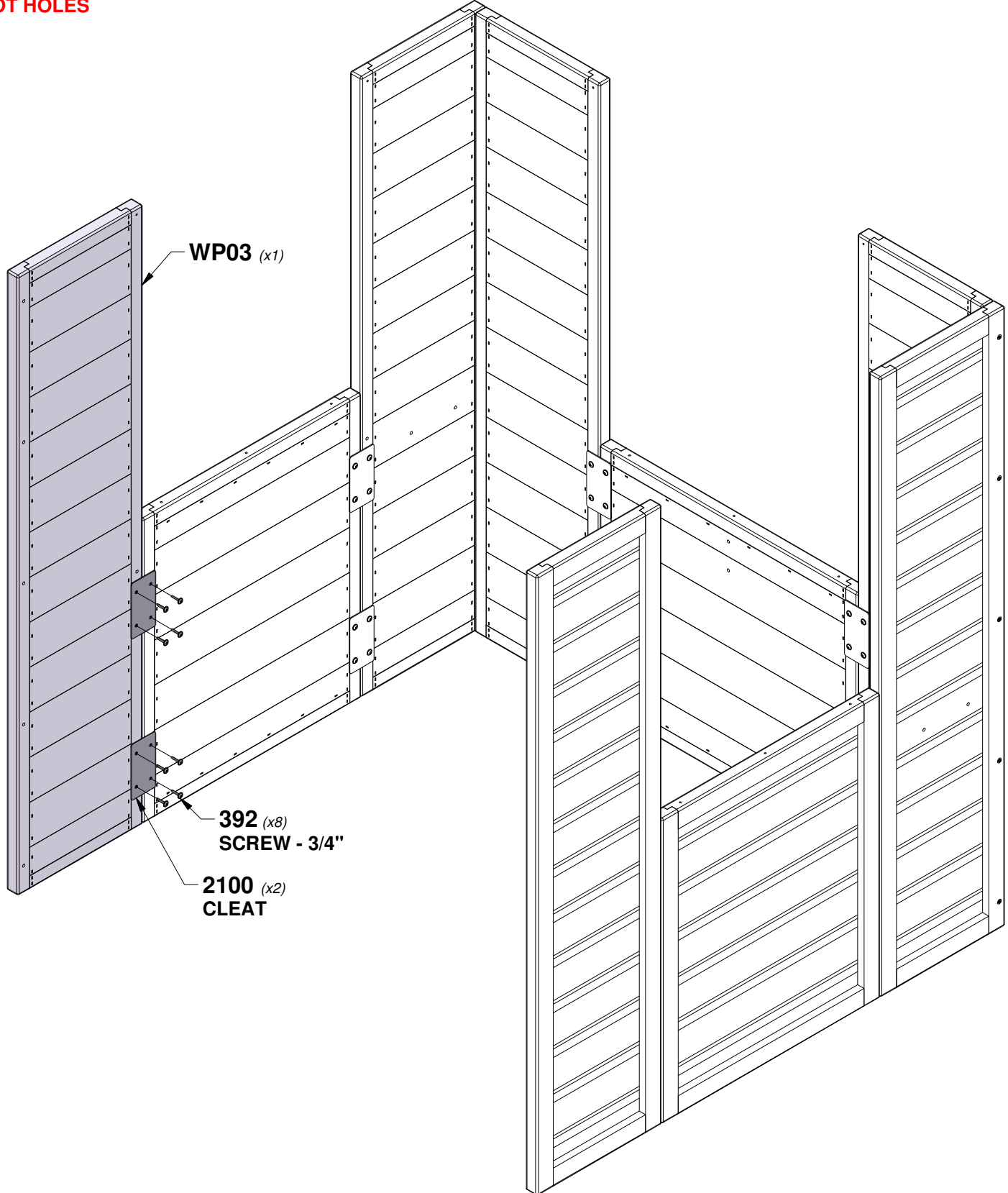

STEP 9 - PLAYHOUSE ASSEMBLY

QTY	PART NUMBER	DESCRIPTION
5	H100391	SCREW PFH 8x2 BLK

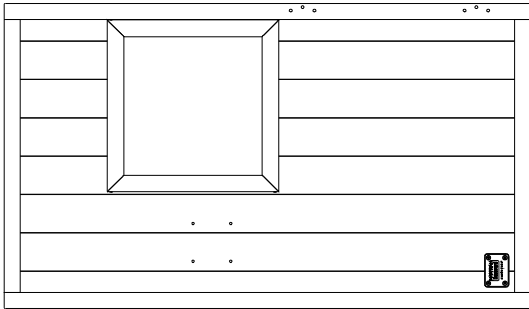

WP07 WALL PANEL - W2A04123
(x1) 1"x10 1/4"x43 7/8" (24x645x1115)

TIP:
ALIGN PILOT HOLES

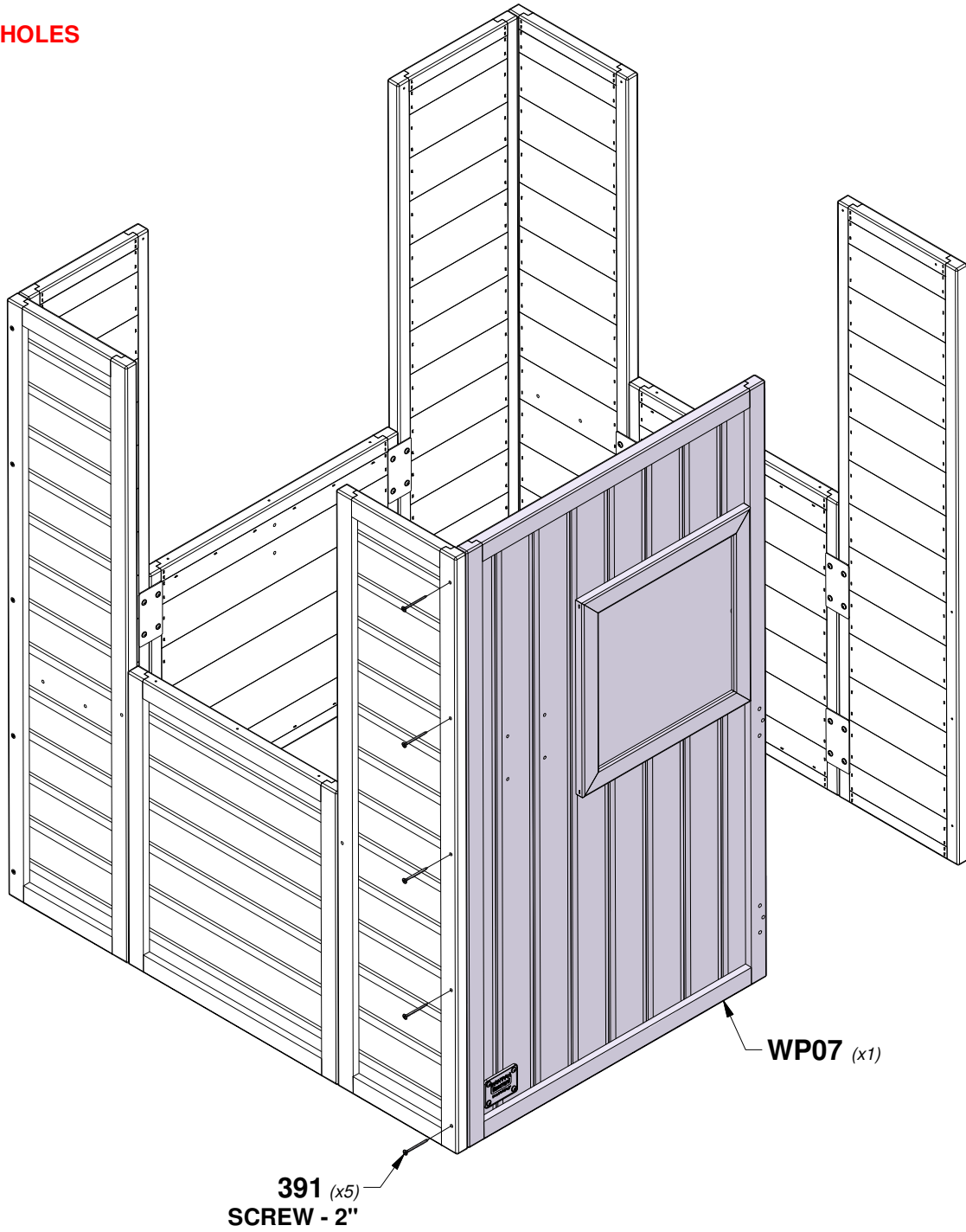

STEP 10 - PLAYHOUSE ASSEMBLY

QTY	PART NUMBER	DESCRIPTION
7	H100392	SCREW PWH 8x3/4 BLK

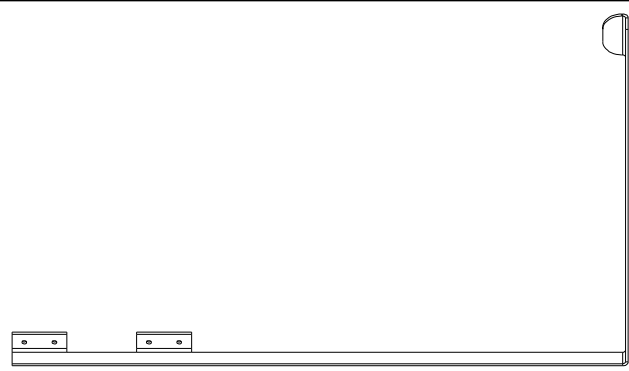

A4M02754 METAL TIE STRAP
(x1)

TIP:
ALIGN PILOT HOLES

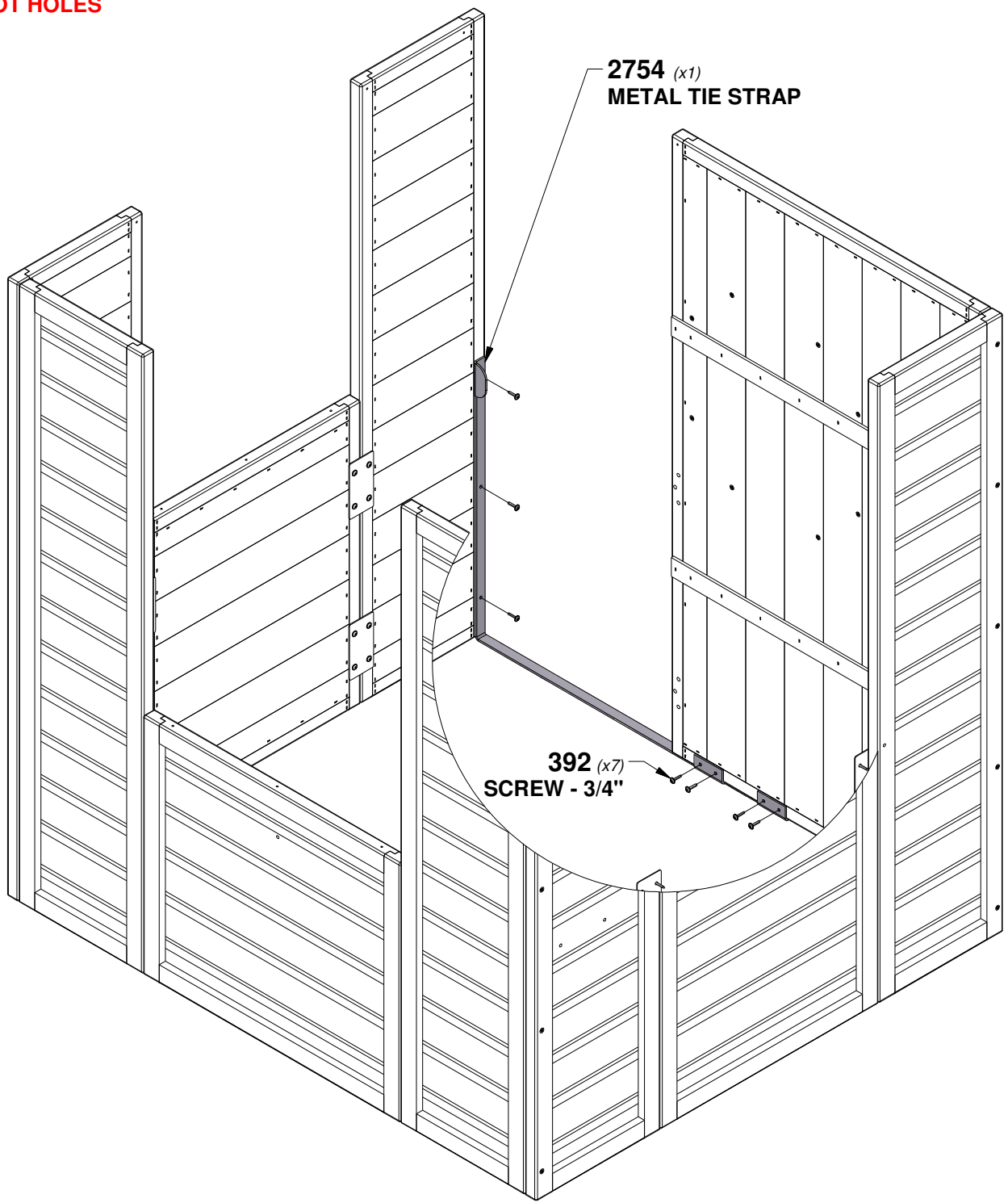

STEP 11 - PLAYHOUSE ASSEMBLY

QTY	PART NUMBER	DESCRIPTION
2	H100200	SCREW PFH 8x1-1/2 BLK
4	H100387	SCREW PFH 8x1-1/4 BLK

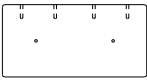

H01 TABLE TOP SUPPORT - W4L19817
 (x2) 1"x3 3/8"x6 3/4" (24x86x172)

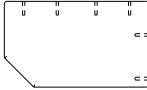

AD01 TABLE TOP SUPPORT - W4L19818
 (x1) 1"x4"x6 3/4" (24x102x172)

TIP:
ALIGN PILOT HOLES

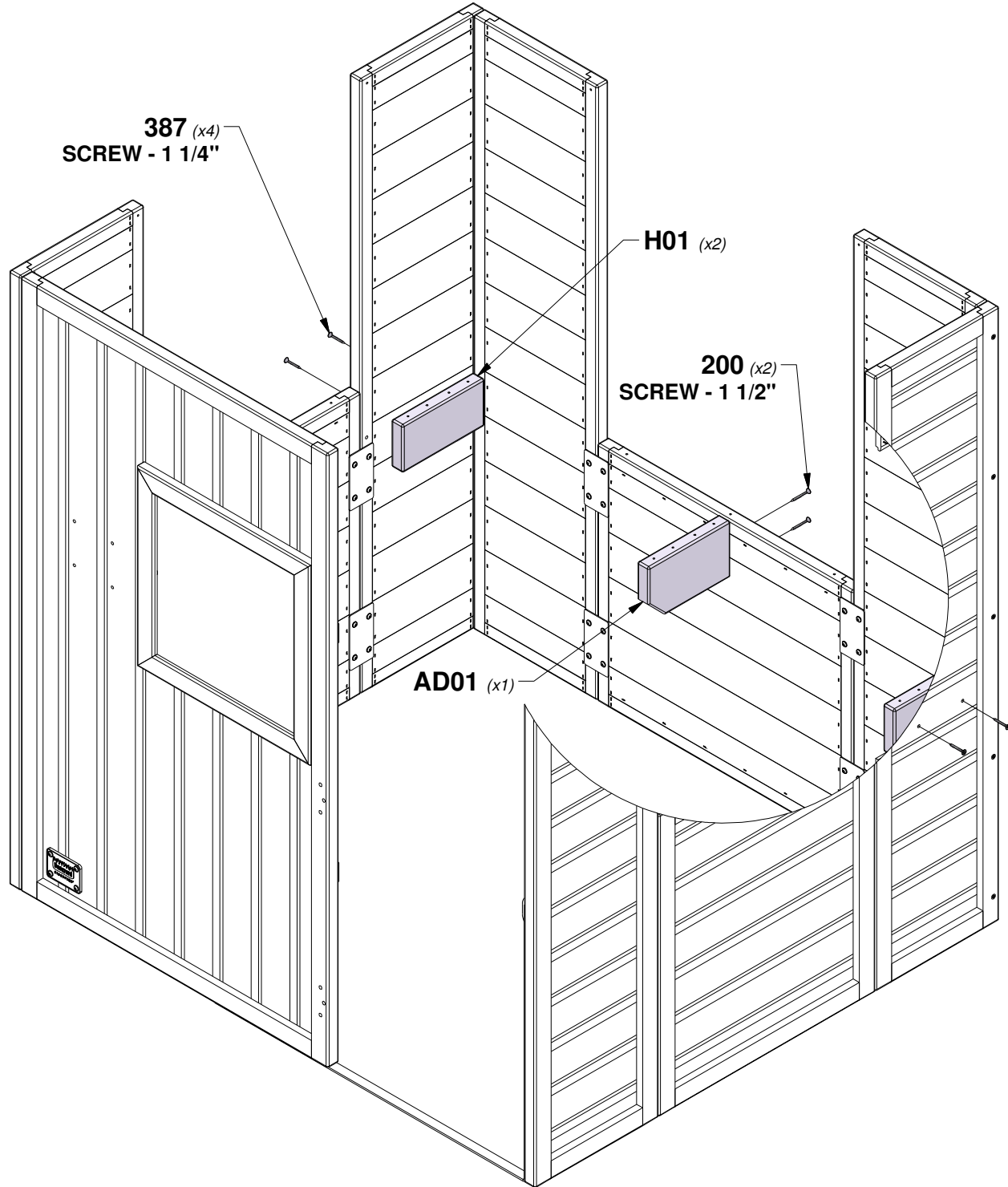

387 (x4)
SCREW - 1 1/4"

H01 (x2)

200 (x2)
SCREW - 1 1/2"

AD01 (x1)

STEP 12 - PLAYHOUSE ASSEMBLY

QTY	PART NUMBER	DESCRIPTION
12	H100200	SCREW PFH 8x1-1/2 BLK

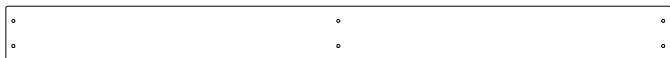

M02 TABLE TOP - W4L19816
(x2) 5/8"x3 3/8"x41 5/8" (16x86x1056)

TIP:
ALIGN PILOT HOLES

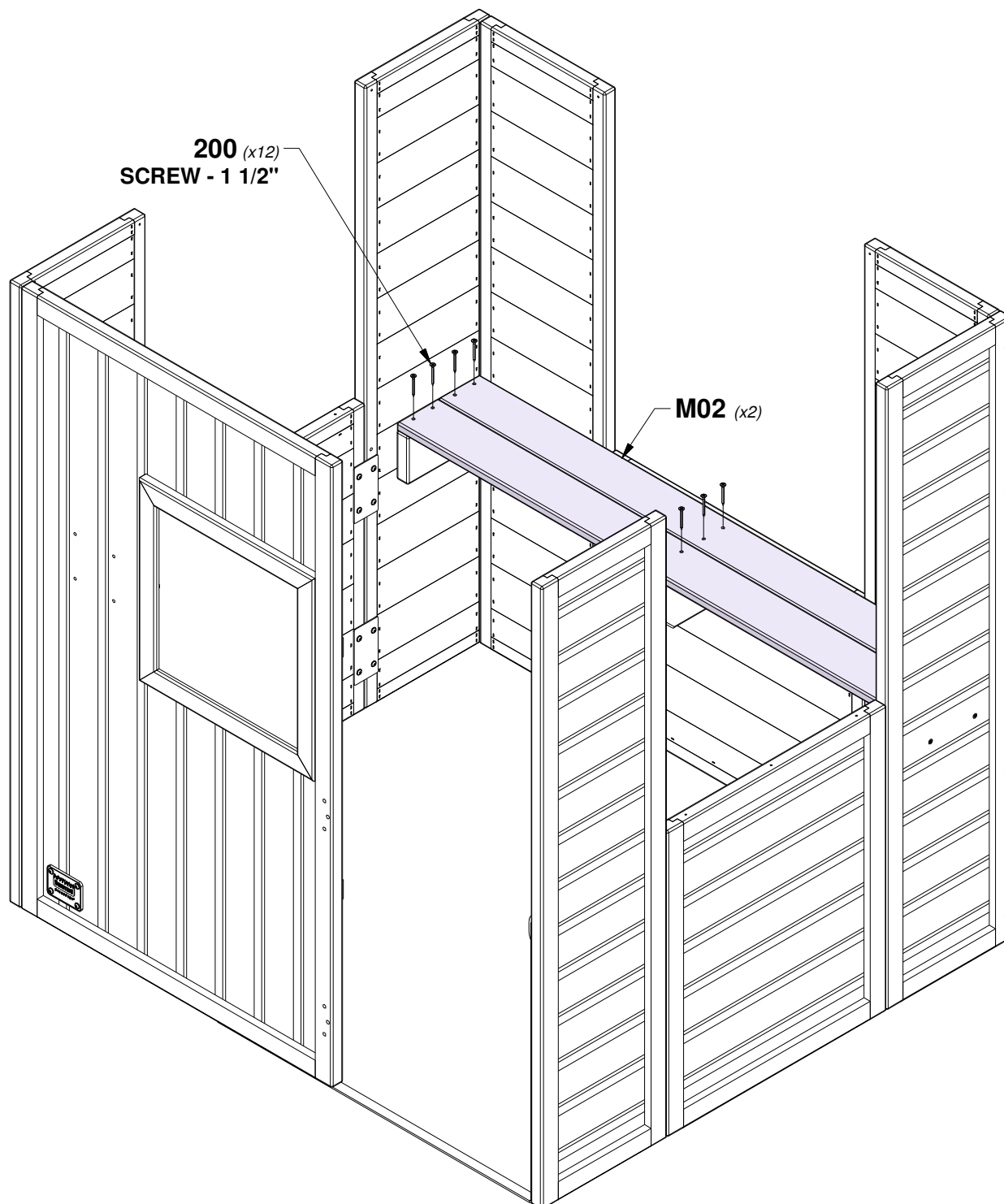

STEP 13 - PLAYHOUSE ASSEMBLY

QTY	PART NUMBER	DESCRIPTION
2	H100200	SCREW PFH 8x1-1/2 BLK

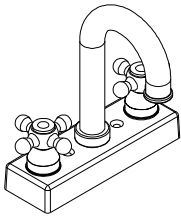

A6P00024
(x1) FAUCET KIT

PLACE AS DESIRED

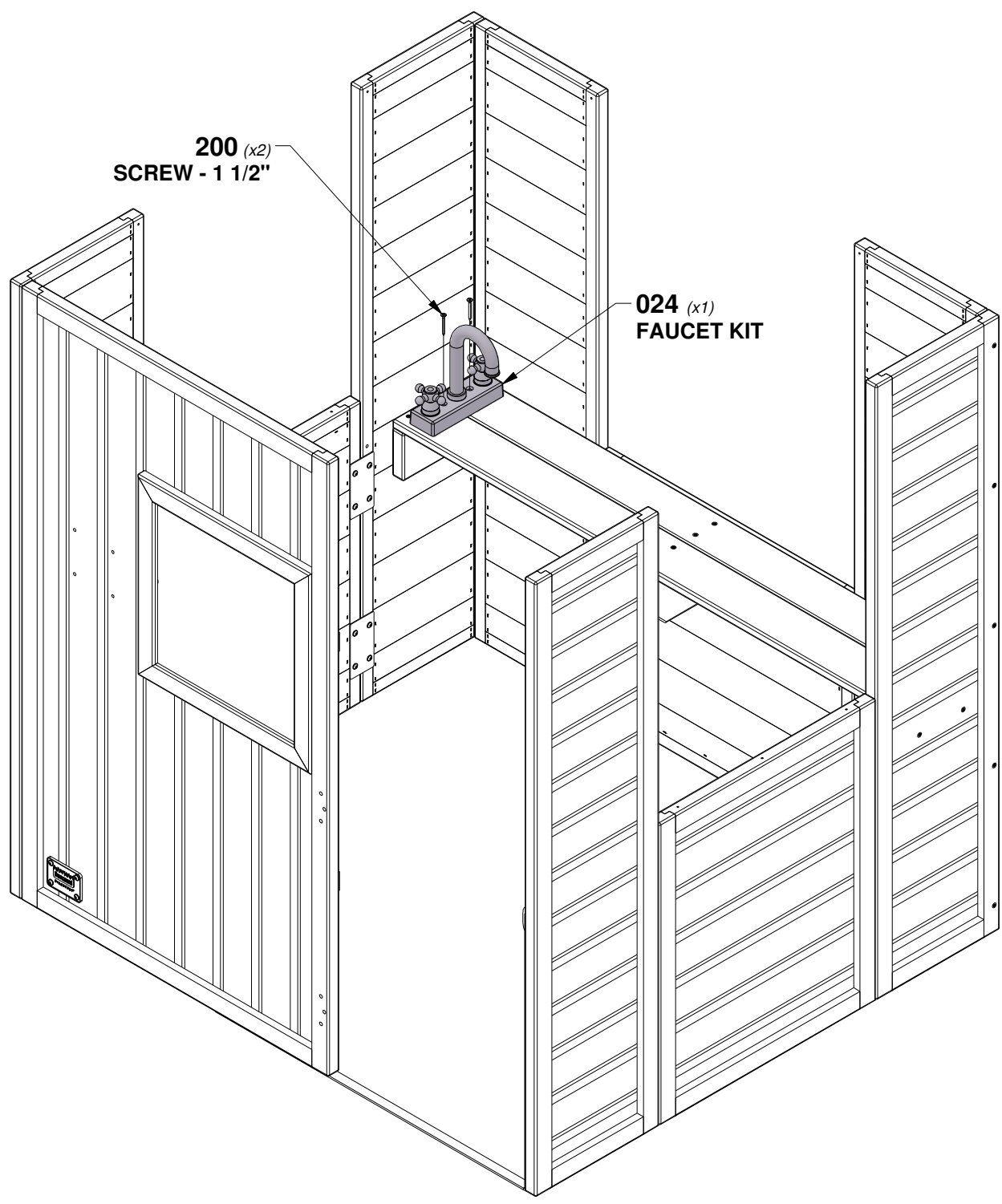

STEP 14 - PLAYHOUSE ASSEMBLY

QTY	PART NUMBER	DESCRIPTION
2	H100202	SCREW PWH 8x5/8 BLK

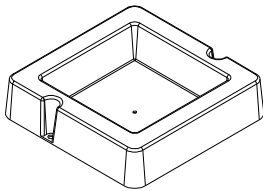

A6P00032 SURFACE MOUNT BASIN
(x1)

PLACE AS DESIRED

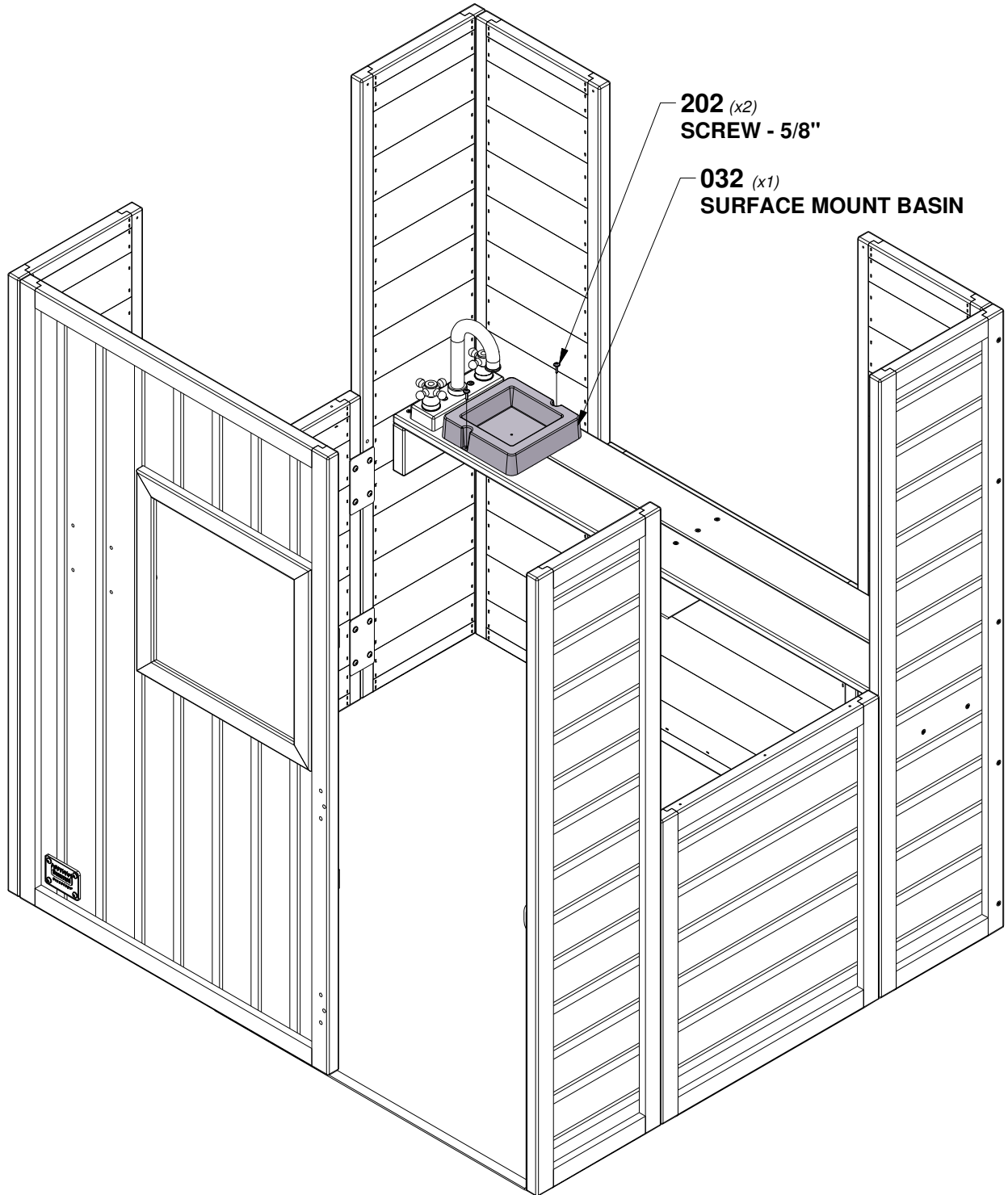

STEP 15 - PLAYHOUSE ASSEMBLY

QTY	PART NUMBER	DESCRIPTION
4	H100385	SCREW PFH 8x1 BLK

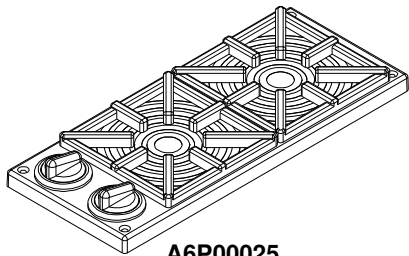

A6P00025
(x1) STOVE KIT

PLACE AS DESIRED

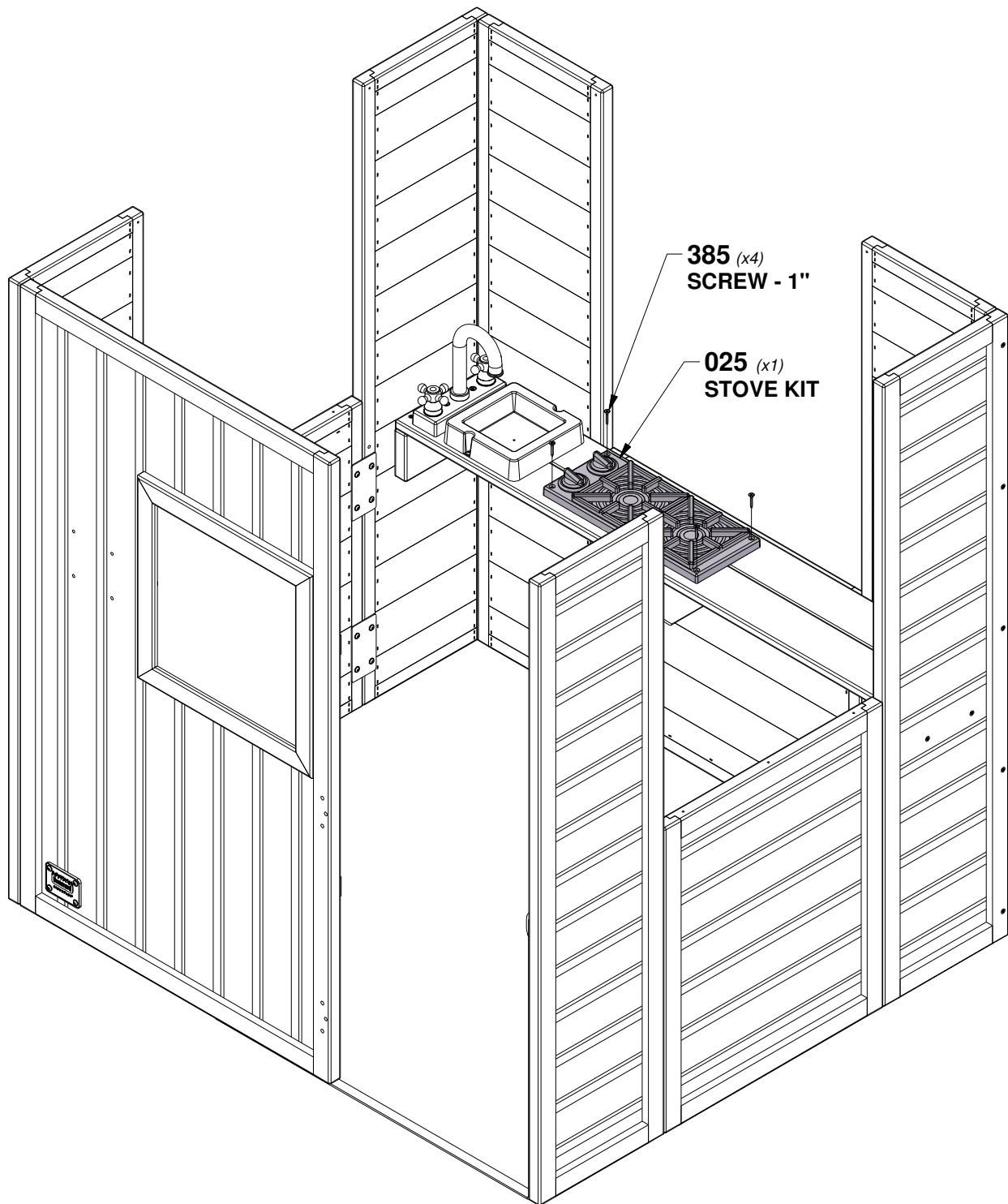

STEP 16 - PLAYHOUSE ASSEMBLY

QTY	PART NUMBER	DESCRIPTION
4	H100392	SCREW PWH 8x3/4 BLK



J01 TOP RAIL - W4L19308
 (x1) 1"x1 3/8"x41 5/8" (24x34x1057)



A4M02752 CLEAT
 (x2)

TIP:
ALIGN PILOT HOLES

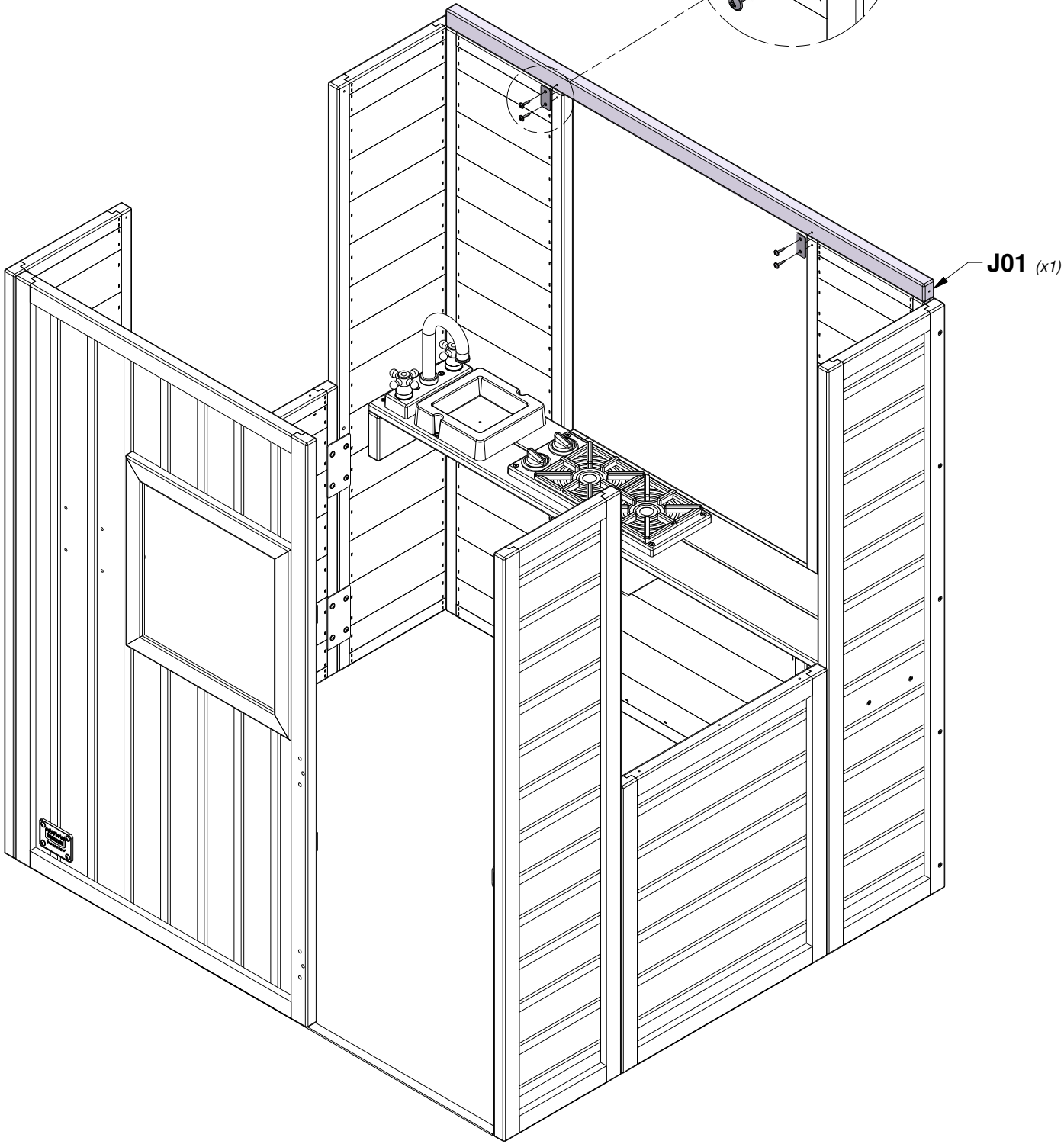
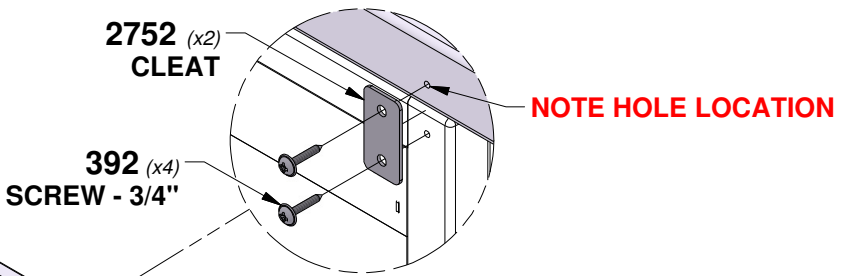

STEP 17 - PLAYHOUSE ASSEMBLY

QTY	PART NUMBER	DESCRIPTION
1	H100391	SCREW PFH 8x2 BLK
4	H100392	SCREW PWH 8x3/4 BLK

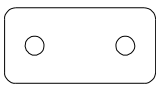
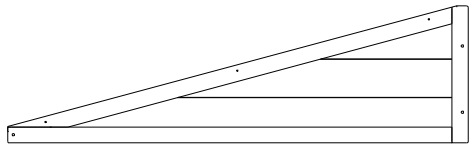

WP08 WALL PANEL - W2A04124
 (x1) 1"x11 3/8"x38 3/8" (24x290x975)

A4M02752 CLEAT
 (x2)

TIP:
ALIGN PILOT HOLES

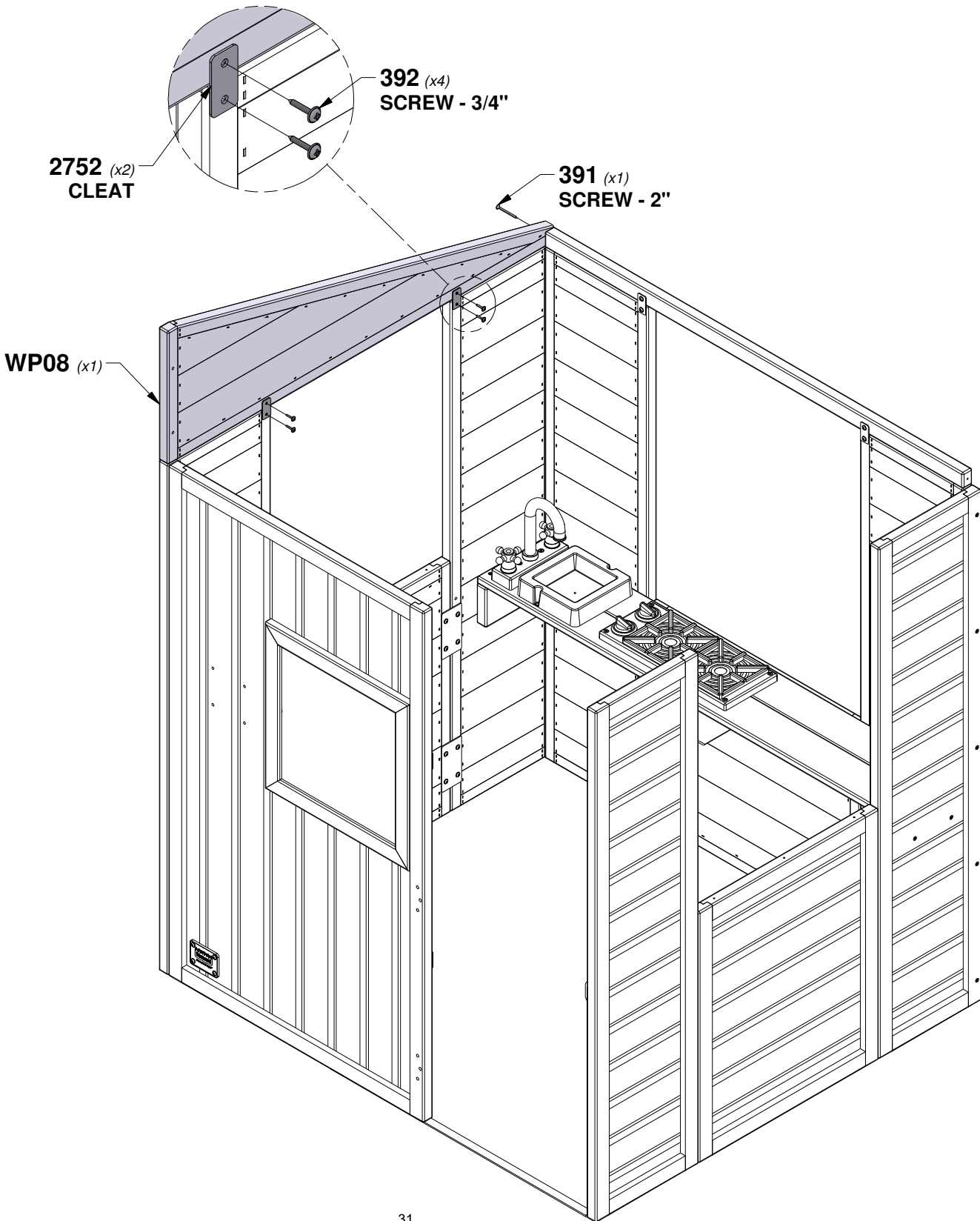

STEP 18 - PLAYHOUSE ASSEMBLY

QTY	PART NUMBER	DESCRIPTION
1	H100391	SCREW PFH 8x2 BLK
6	H100392	SCREW PWH 8x3/4 BLK

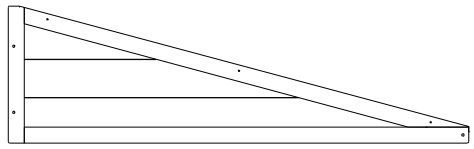

WP06 WALL PANEL - W2A04122
 (x1) 1"x11 3/8"x38 3/8" (24x290x975)

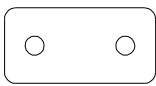

A4M02752 CLEAT
 (x3)

TIP:
ALIGN PILOT HOLES

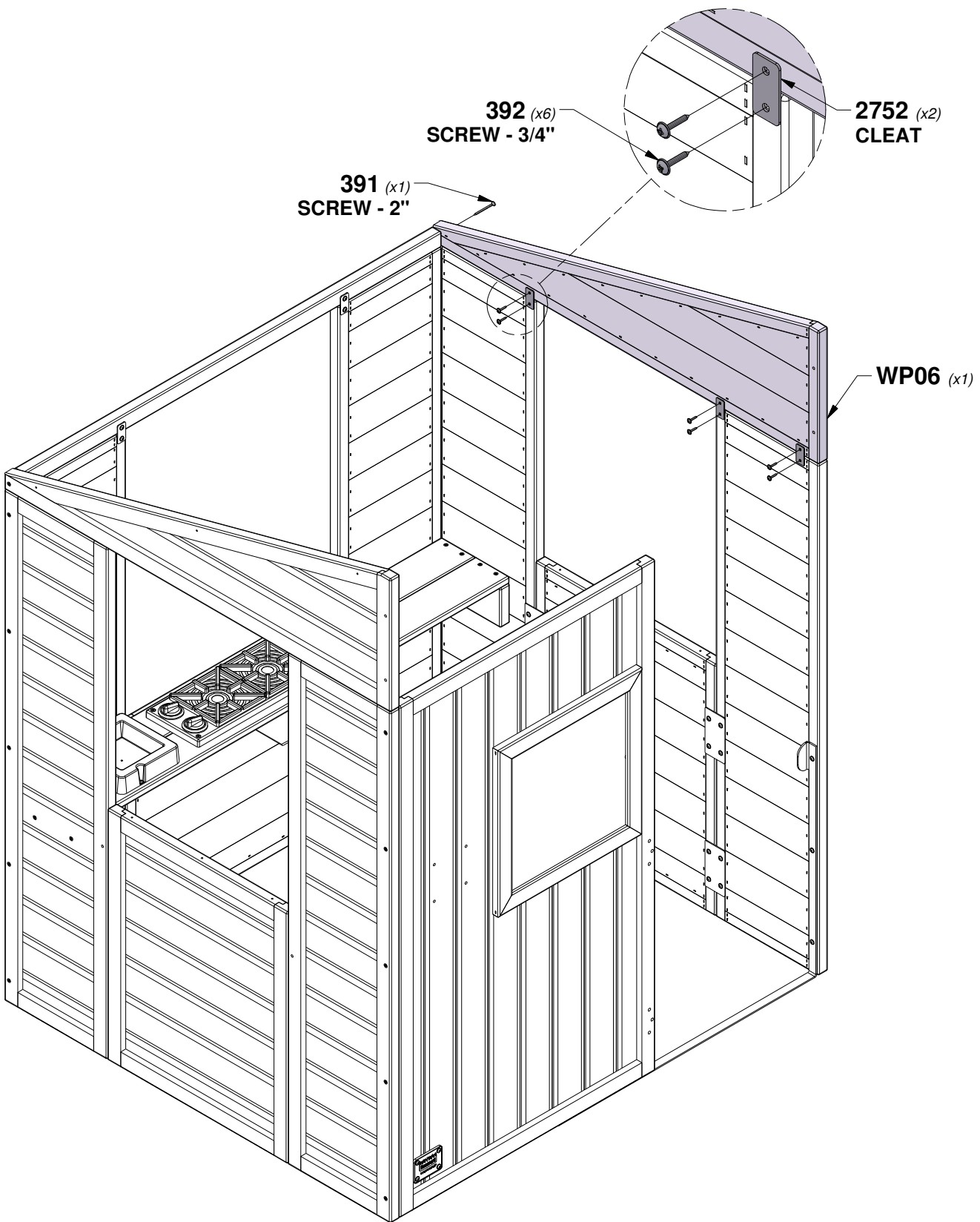

STEP 19 - PLAYHOUSE ASSEMBLY

QTY	PART NUMBER	DESCRIPTION
4	H100391	SCREW PFH 8x2 BLK
2	H100392	SCREW PWH 8x3/4 BLK

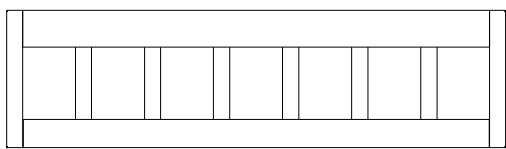

WP11 WALL PANEL - W2A04128
 (x1) 15/16"x11 7/16"x41 5/8" (24x290x1057)

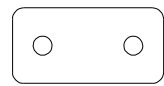

A4M02752 CLEAT
 (x1)

TIP:
ALIGN PILOT HOLES

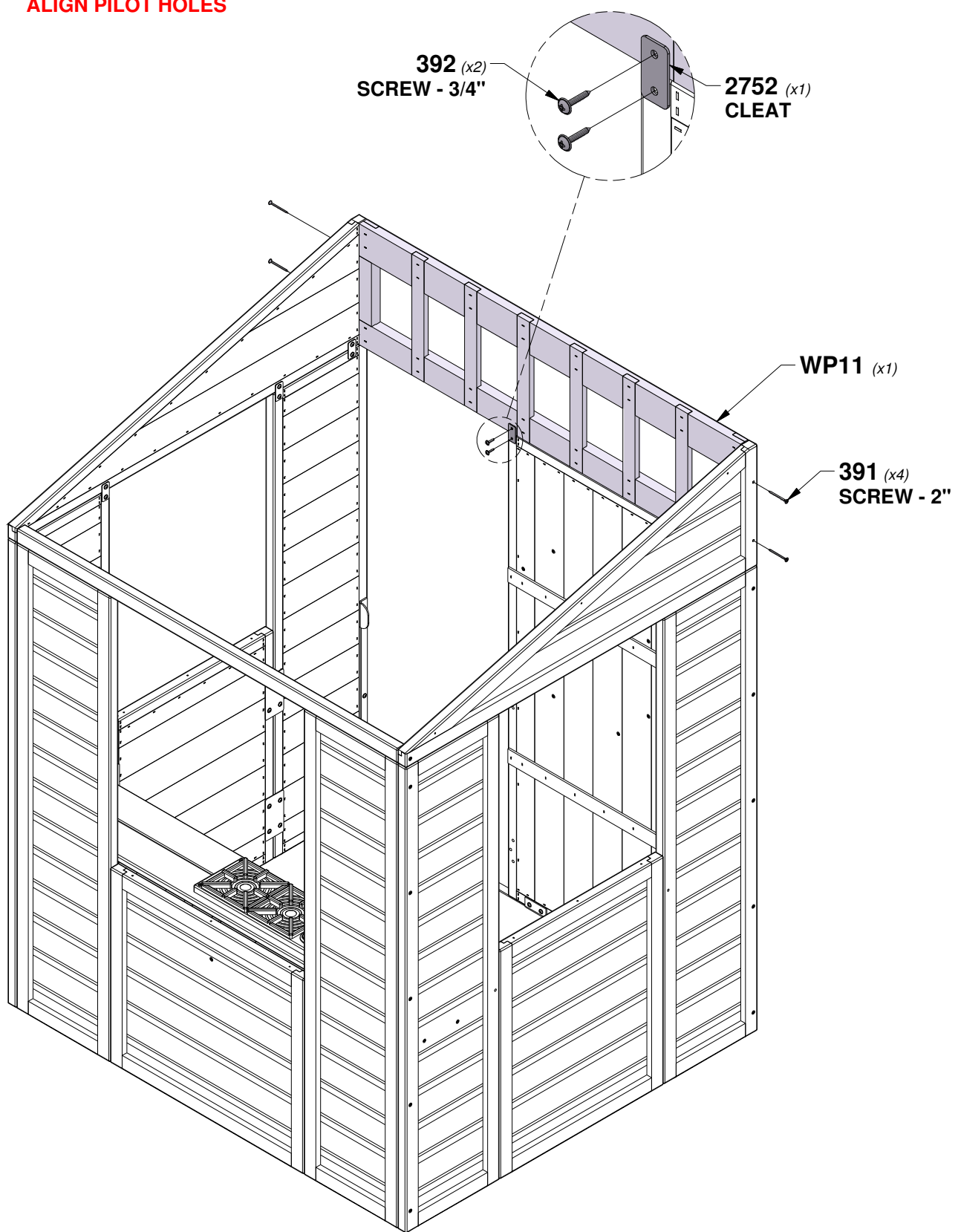

STEP 20 - PLAYHOUSE ASSEMBLY

QTY	PART NUMBER	DESCRIPTION
3	H100382	SCREW PFH 8x1 3/4 BLK

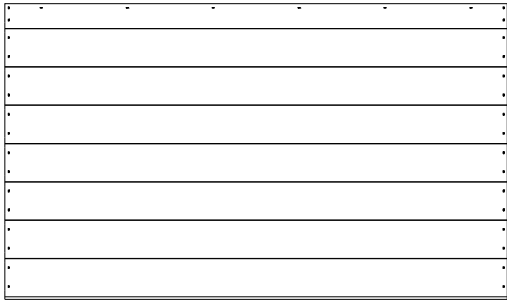

RP01 ROOF PANEL - W2A04130
(x1) 1 3/8"x24 5/8"x41 7/8" (35x625x1064)

TIP:
ALIGN PILOT HOLES

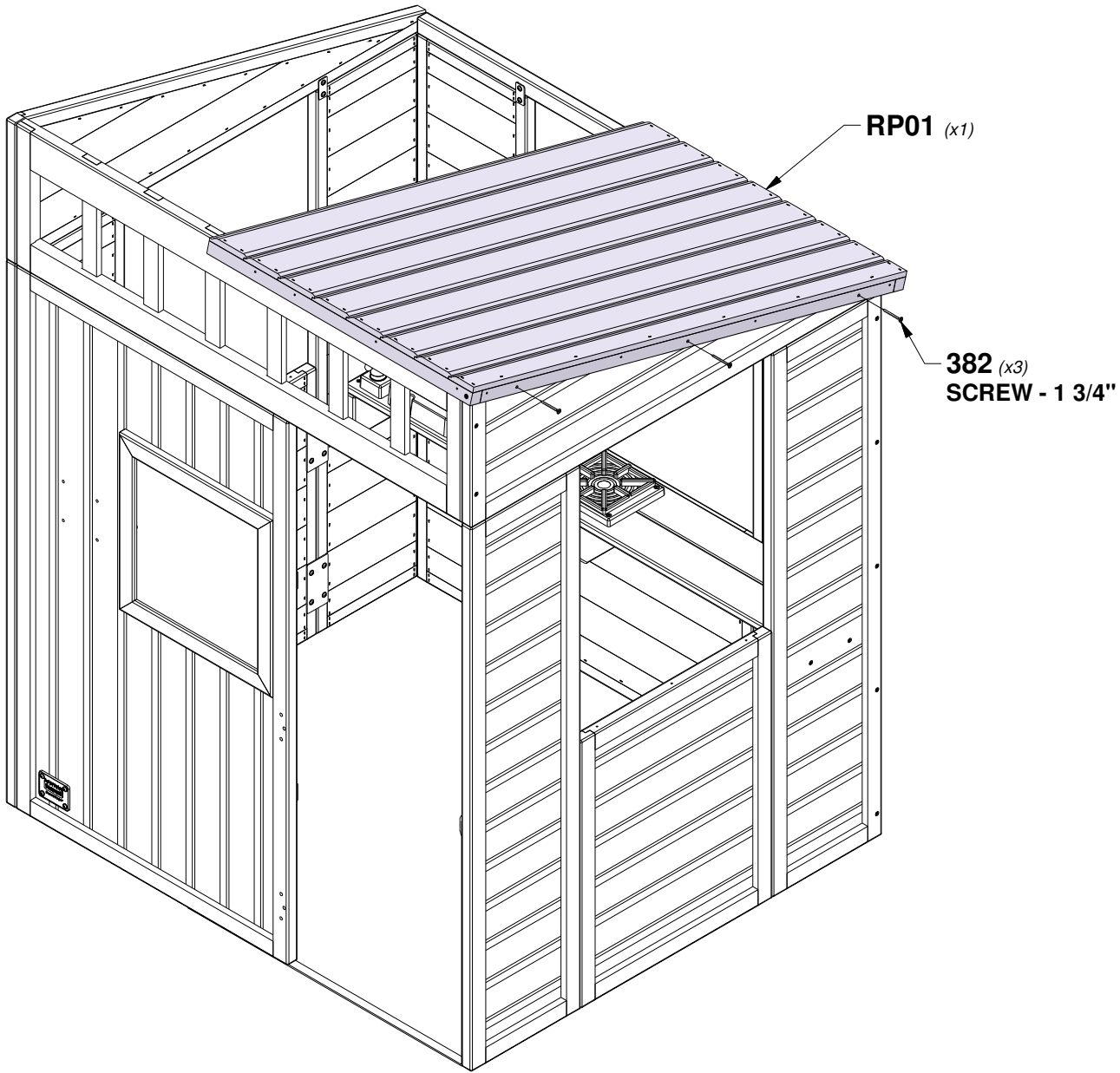

STEP 21 - PLAYHOUSE ASSEMBLY

QTY	PART NUMBER	DESCRIPTION
3	H100382	SCREW PFH 8x1 3/4 BLK

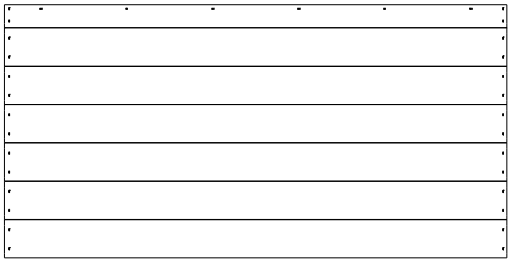

RP02 ROOF PANEL - W2A04131
(x1) 1 3/8"x21 1/8"x41 7/8" (35x535x1064)

TIP:
ALIGN PILOT HOLES

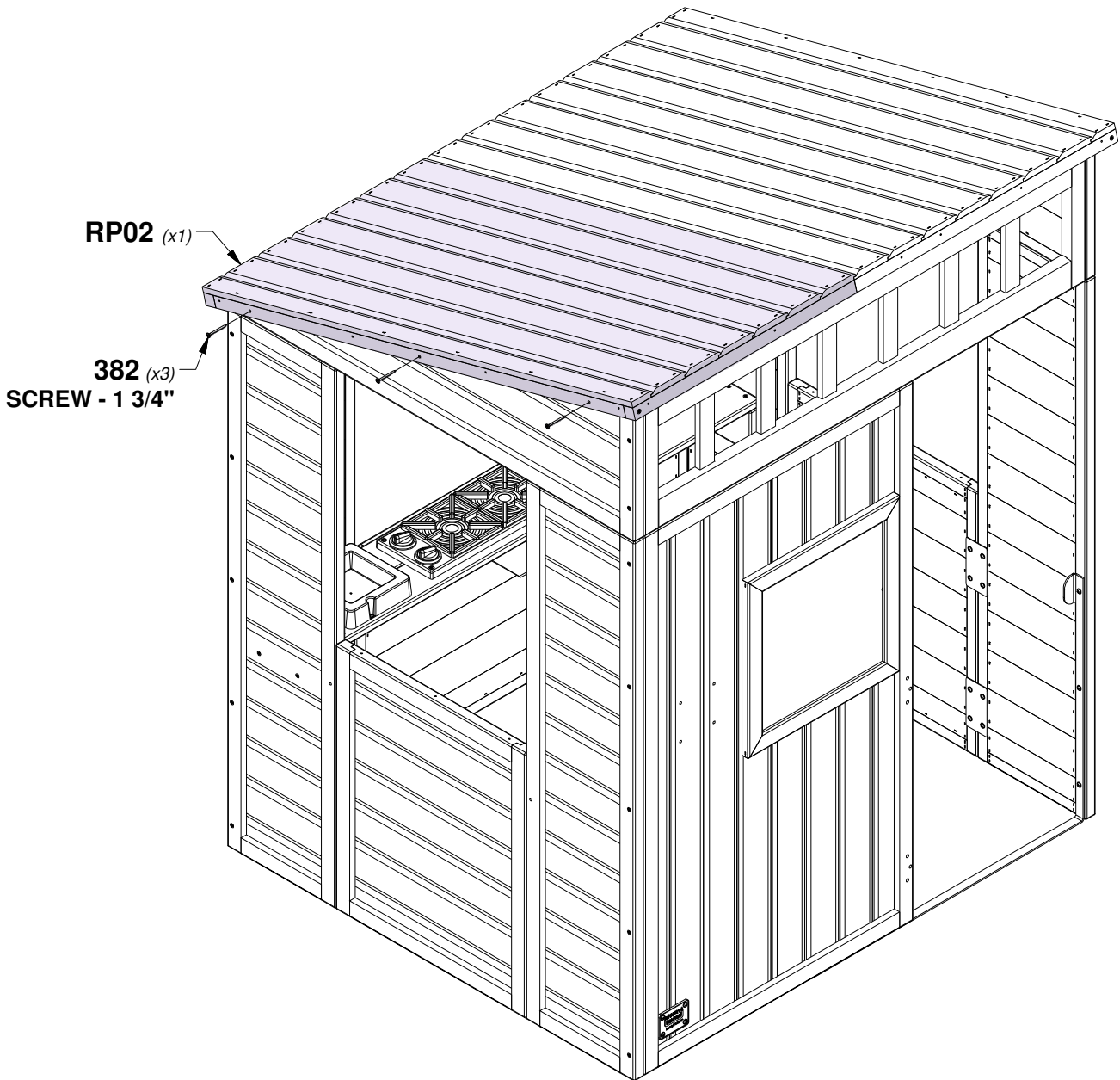

STEP 22 - PLAYHOUSE ASSEMBLY

QTY	PART NUMBER	DESCRIPTION
6	H100387	SCREW PFH 8x1-1/4 BLK

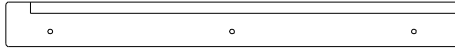

F03 ROOF TRIM - W4L19820
(x1) 1"x1 7/8"x18 7/8" (26x47x479)

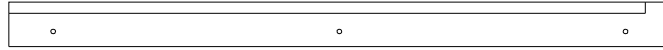

F02 ROOF TRIM - W4L19316
(x1) 1"x1 7/8"x27 1/2" (26x47x700)

TIP:
ALIGN PILOT HOLES

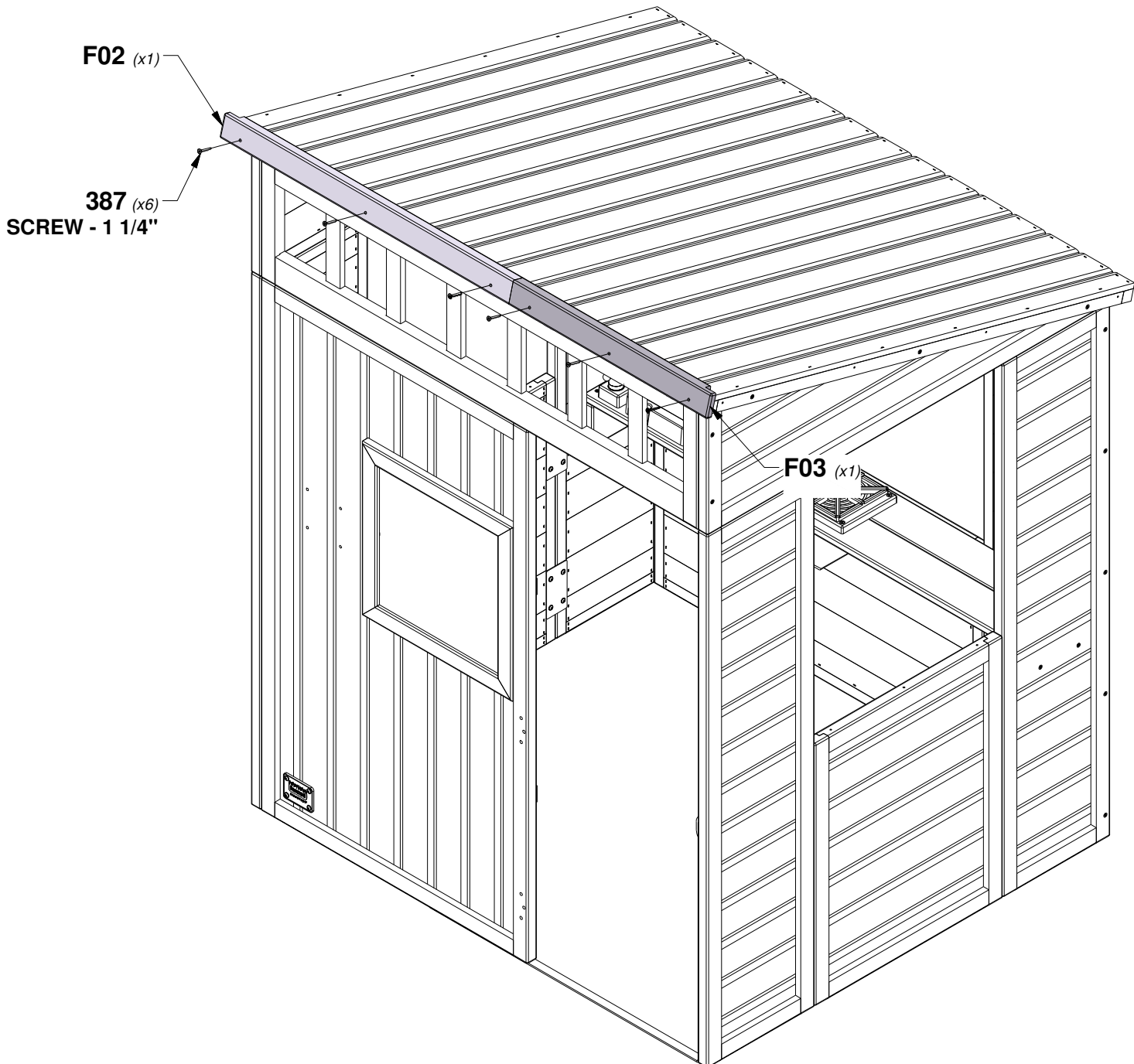

STEP 23 - PLAYHOUSE ASSEMBLY

QTY	PART NUMBER	DESCRIPTION
4	H100387	SCREW PFH 8x1-1/4 BLK



F01 ROOF TRIM - W4L19315
(x1) 1"x1 7/8"x41 7/8" (26x47x1064)

TIP:
ALIGN PILOT HOLES

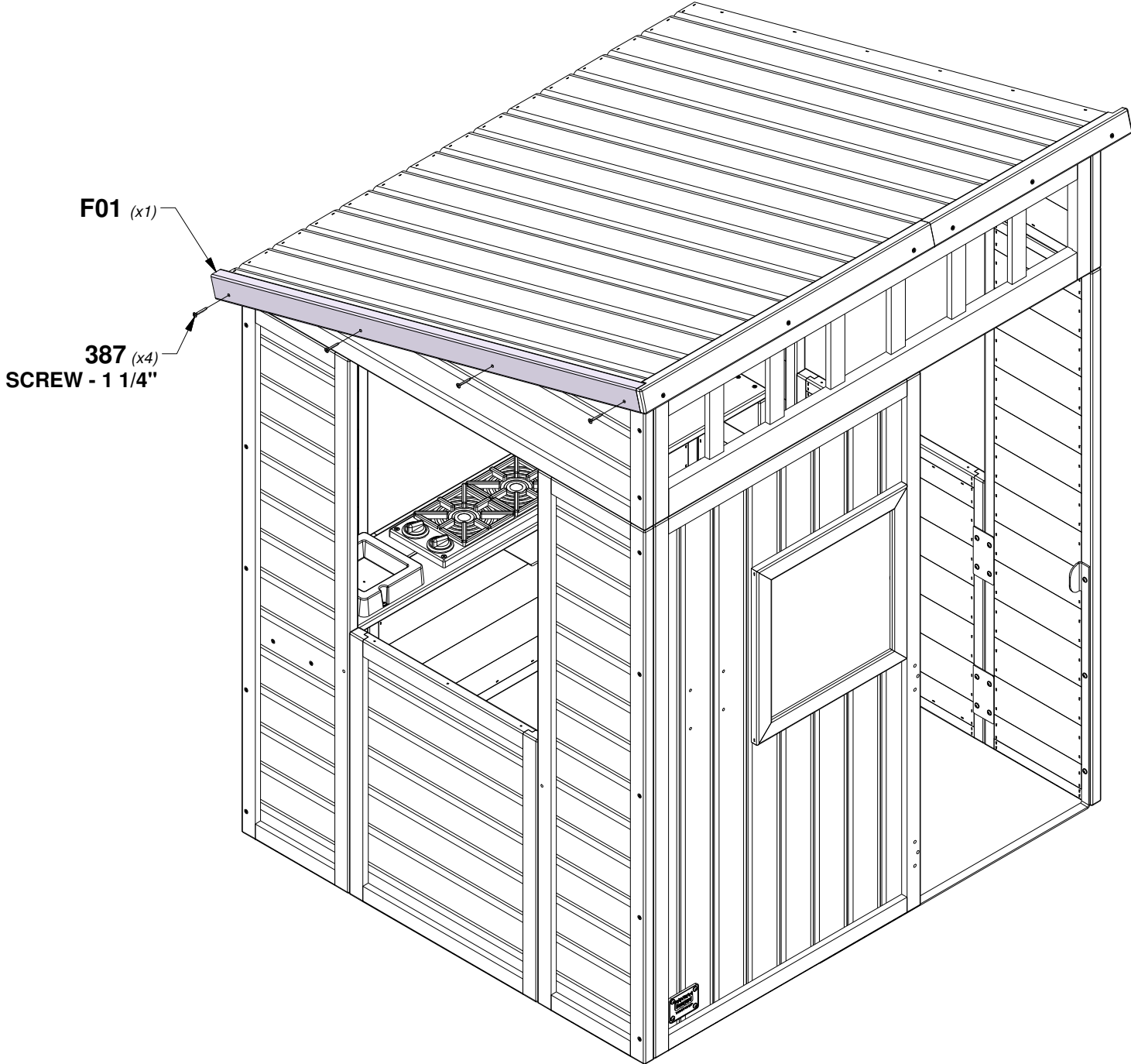

STEP 24 - PLAYHOUSE ASSEMBLY

QTY	PART NUMBER	DESCRIPTION
4	H100387	SCREW PFH 8x1-1/4 BLK



F01 ROOF TRIM - W4L19315
(x1) 1"x1 7/8"x41 7/8" (26x47x1064)

TIP:
ALIGN PILOT HOLES

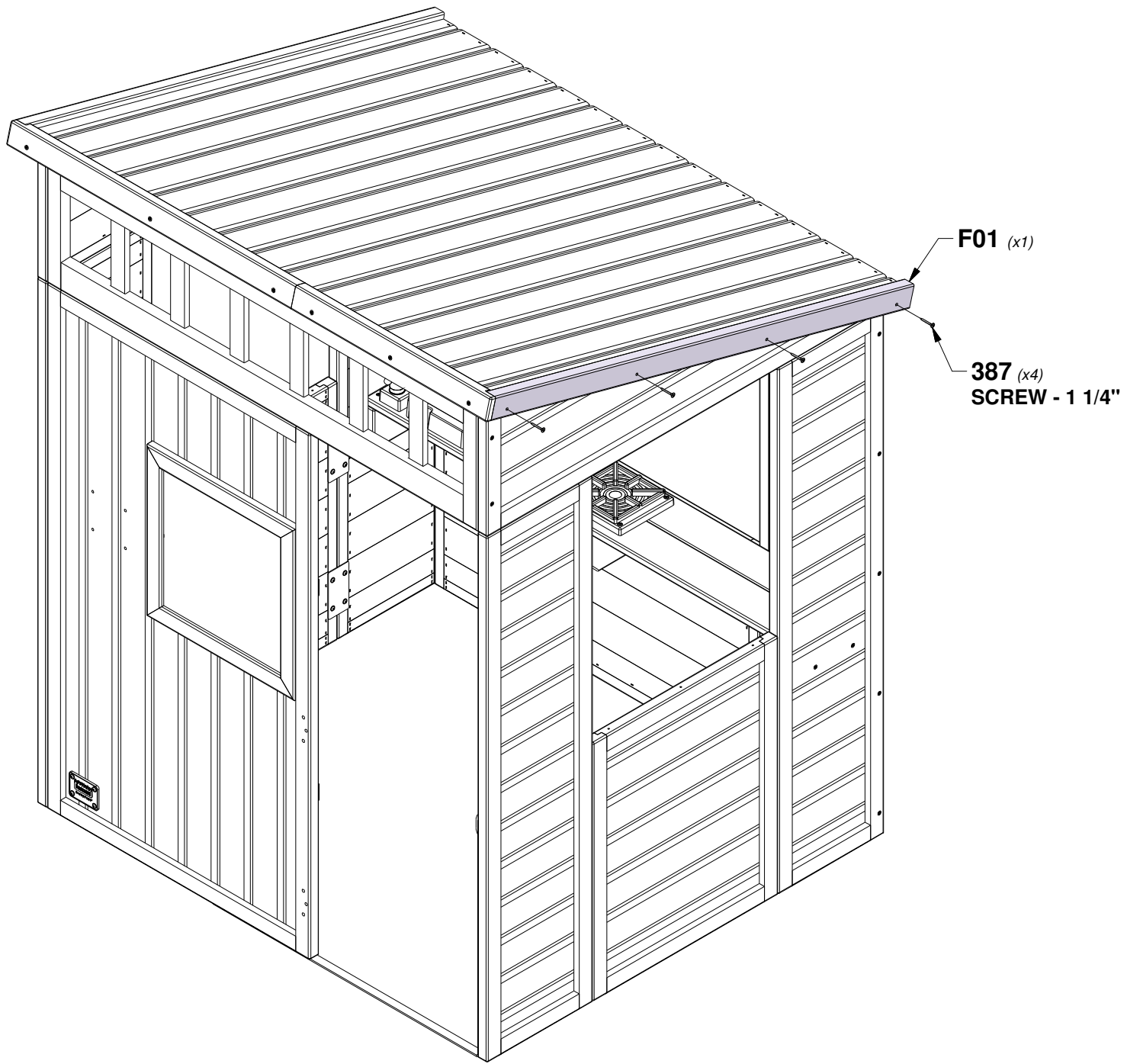

STEP 25 - PLAYHOUSE ASSEMBLY

QTY	PART NUMBER	DESCRIPTION
7	H100387	SCREW PFH 8x1-1/4 BLK

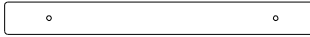

N04 ROOF TRIM - W4L19819
(x1) 5/8"x1 3/8"x12 3/4" (16x34x324)

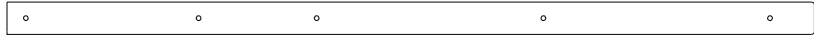

N03 ROOF TRIM - W4L19317
(x1) 5/8"x1 3/8"x33 5/8" (16x34x855)

TIP:
ALIGN PILOT HOLES

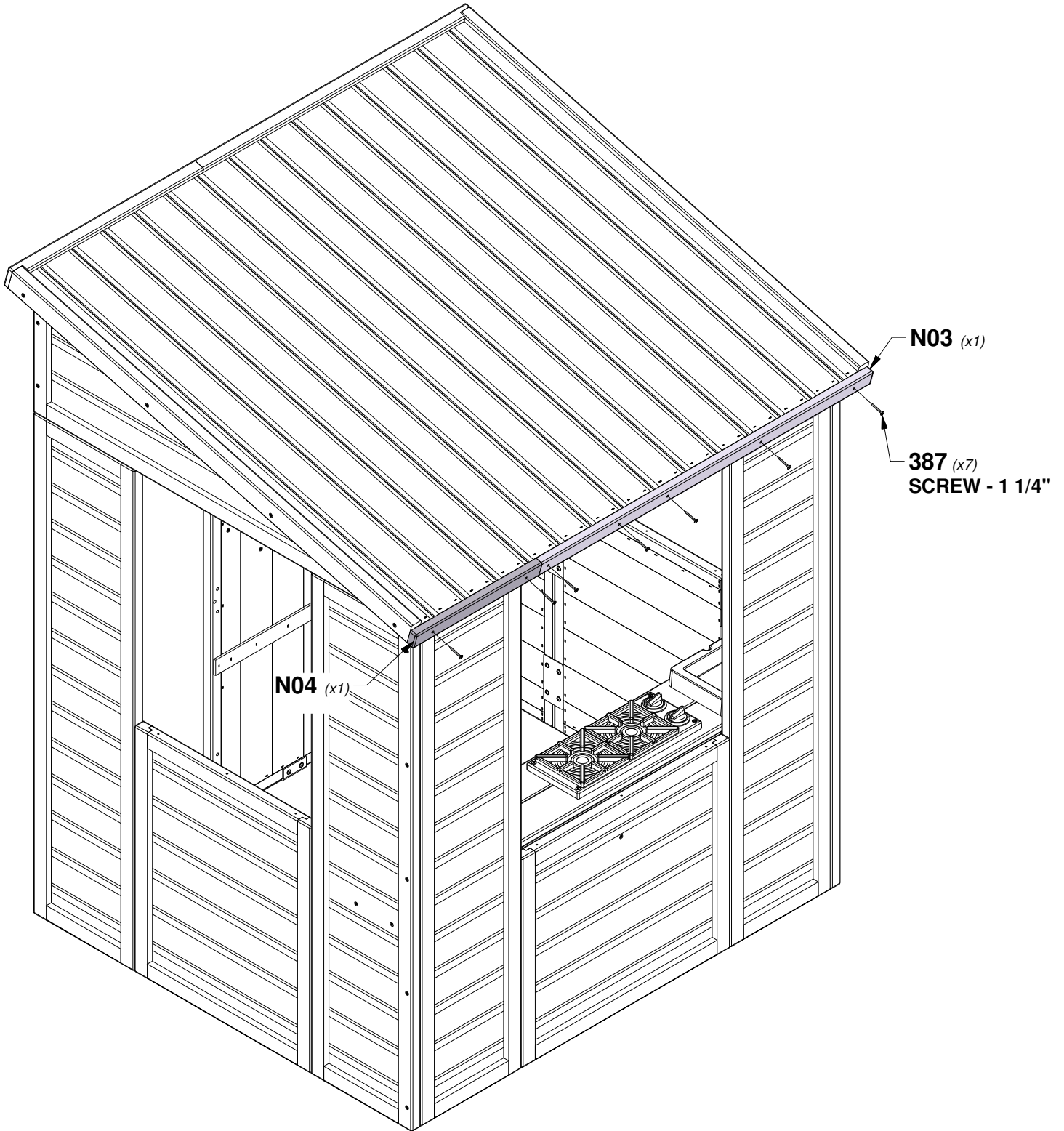

STEP 26 - PLAYHOUSE ASSEMBLY

QTY	PART NUMBER	DESCRIPTION
12	H100804	T-NUT 8/32
12	H100807	SCREW POH-MS 8/32x1 BLK

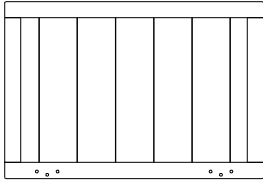

DP01 DOOR PANEL - W2A04125
(x1) 1"x10 1/4"x43 7/8" (24x374x548)



A4M00624 HINGE (DOOR, SPRING LOADED)
(x1)



A4M00994 HINGE (DOOR, NON-SPRING LOADED)
(x1)

TIP:
INSTALL T-NUTS IN WOOD FIRST

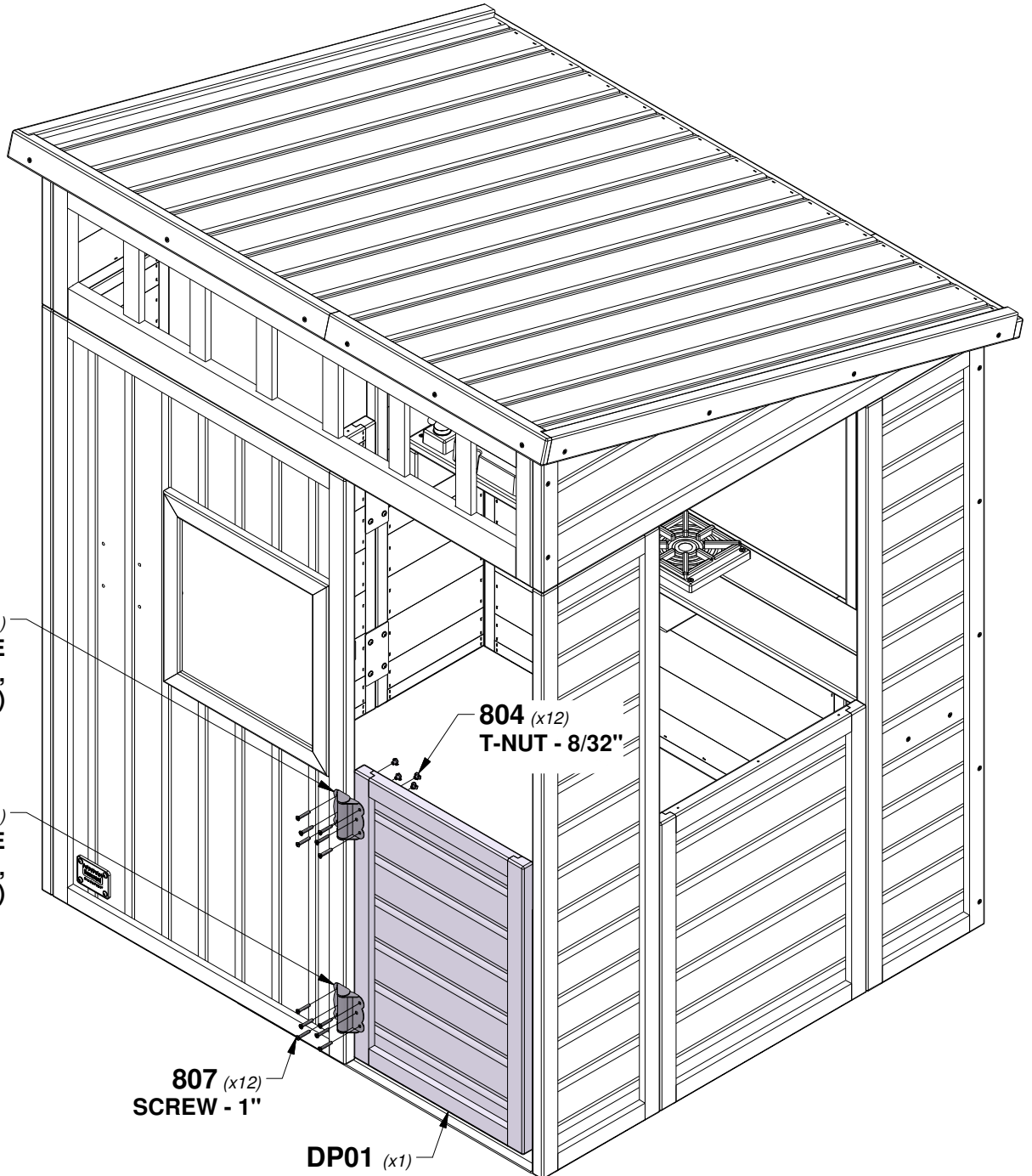

STEP 27 - PLAYHOUSE ASSEMBLY

QTY	PART NUMBER	DESCRIPTION
4	H100797	SCREW PWH 8x1 BLK

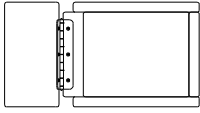

MB01 MAILBOX - W2A04129
(x1) 3 3/8"x6 9/16"x8 3/4" (86x166x222)

TIP:
ALIGN PILOT HOLES

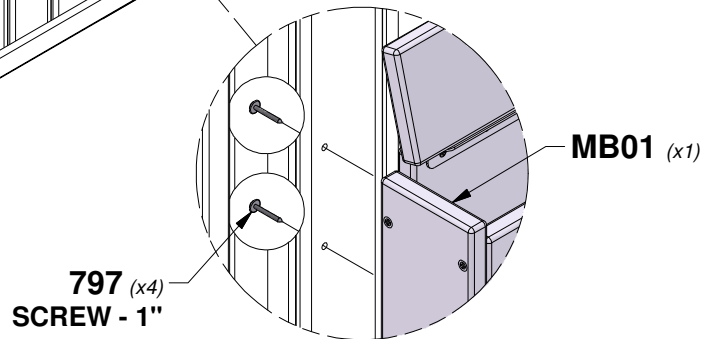
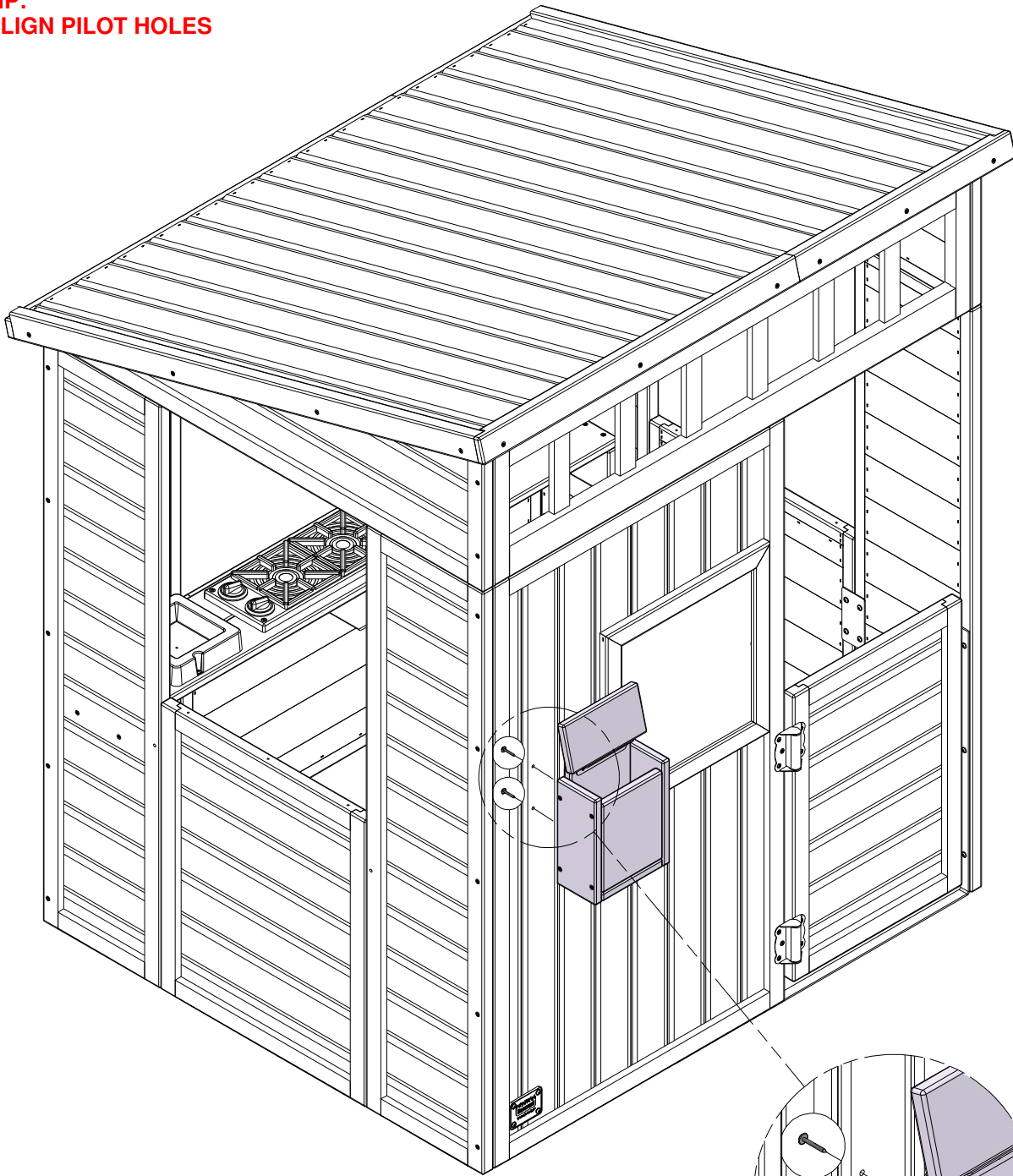

STEP 28 - PLAYHOUSE ASSEMBLY

QTY	PART NUMBER	DESCRIPTION
2	H100391	SCREW PFH 8x2 BLK

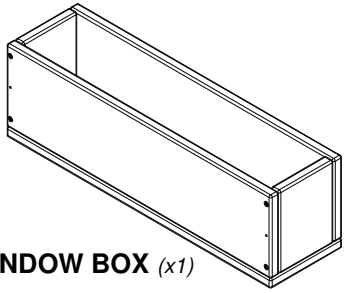

WINDOW BOX (x1)

TIP:
ALIGN PILOT HOLES

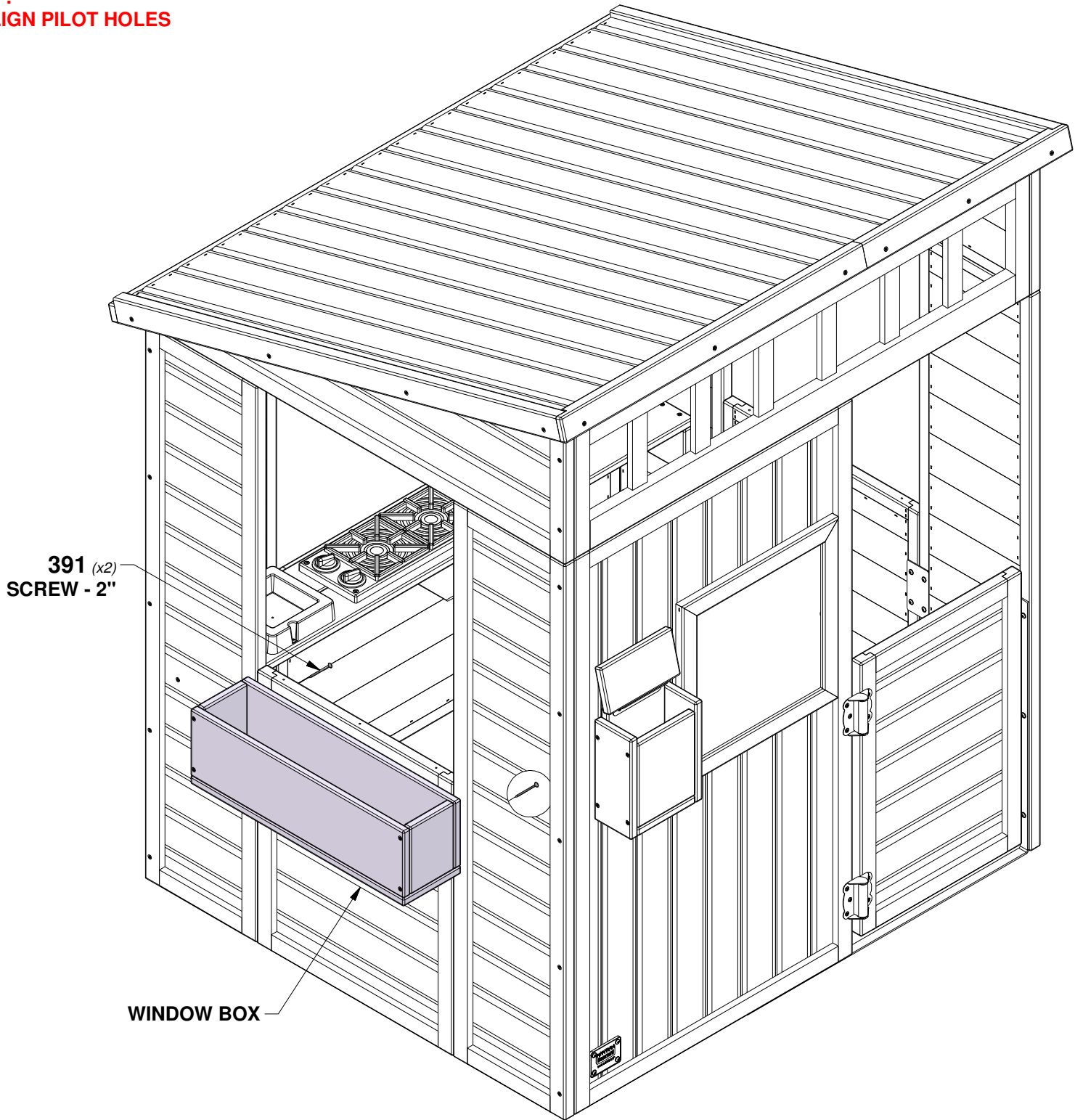

STEP 29 - PLAYHOUSE ASSEMBLY

QTY	PART NUMBER	DESCRIPTION
3	H100200	SCREW PFH 8x1-1/2 BLK

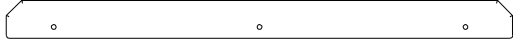

N02 WINDOW BOARD - W4L19310
(x1) 5/8"x1 5/8"x21 1/8" (16x40x536)

TIP:
ALIGN PILOT HOLES

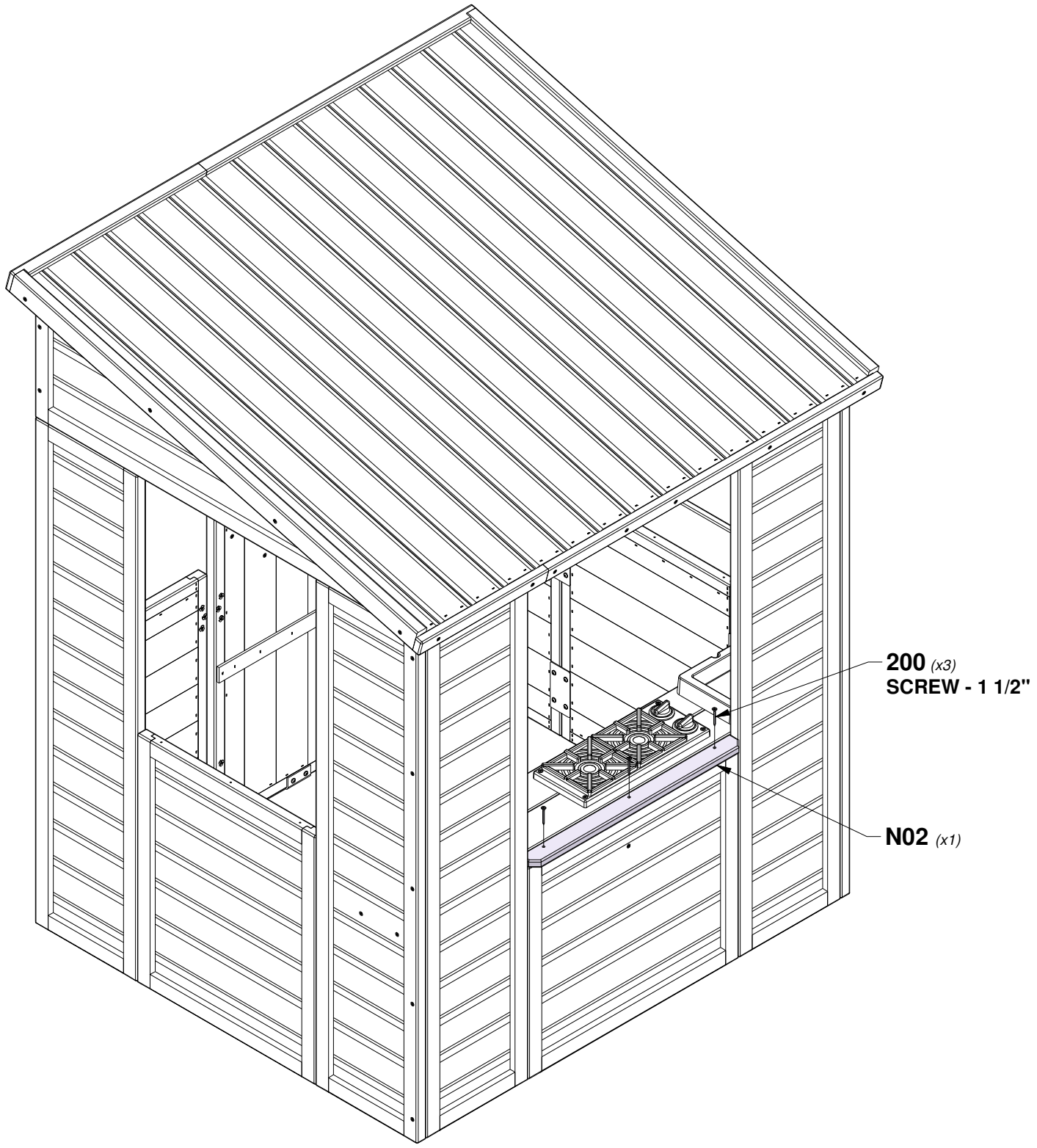

STEP 30 - PLAYHOUSE ASSEMBLY

QTY	PART NUMBER	DESCRIPTION
3	H100200	SCREW PFH 8x1-1/2 BLK



N01 WINDOW BOARD - W4L19309
(x1) 5/8"x1 5/8"x17 7/8" (16x40x454)

TIP:
ALIGN PILOT HOLES

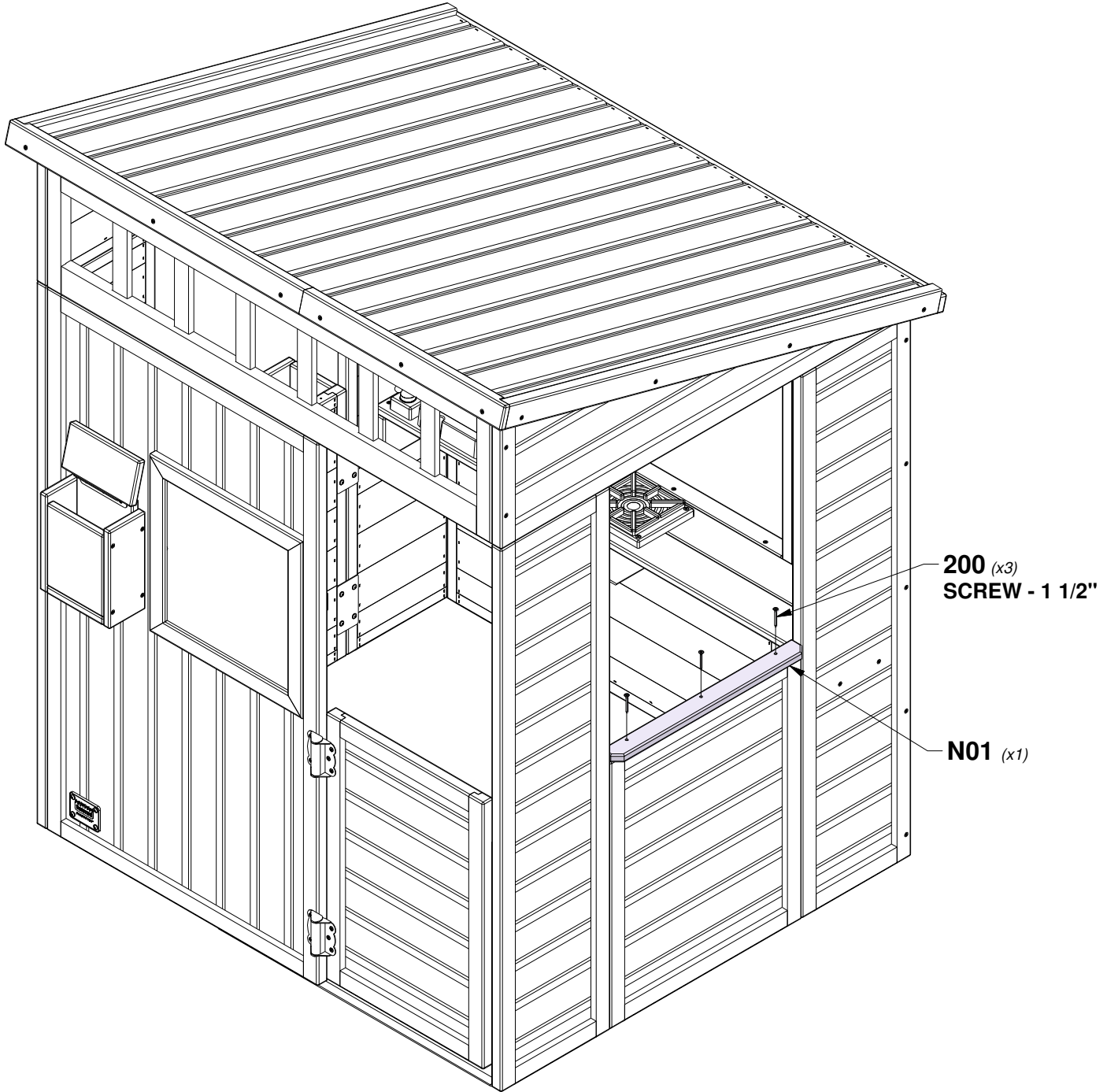

STEP 31 - PLAYHOUSE ASSEMBLY

QTY	PART NUMBER	DESCRIPTION
3	H100200	SCREW PFH 8x1-1/2 BLK



N01 WINDOW BOARD - W4L19309
(x1) 5/8"x1 5/8"x17 7/8" (16x40x454)

TIP:
ALIGN PILOT HOLES

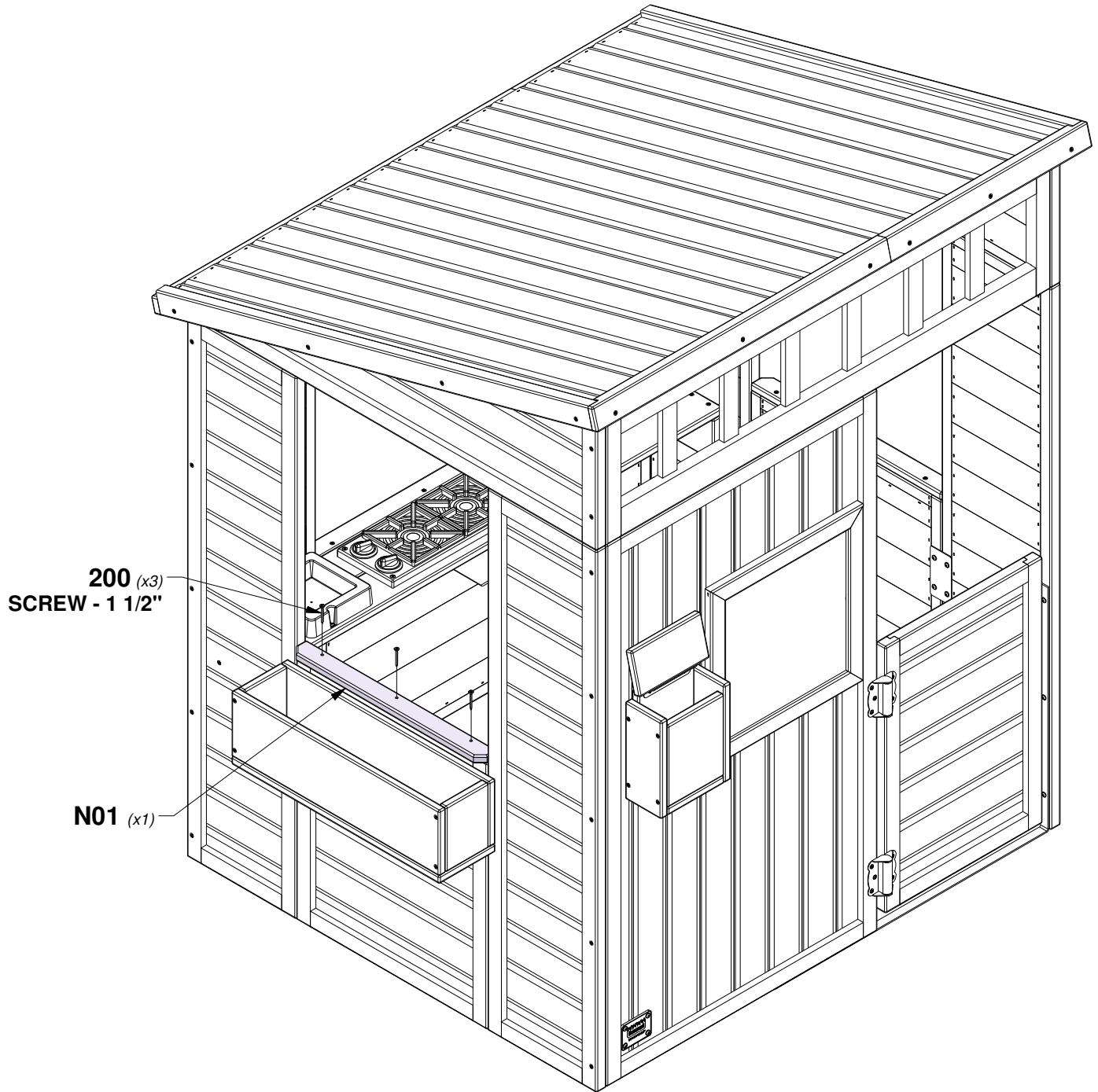

STEP 32 - PLAYHOUSE ASSEMBLY

QTY	PART NUMBER	DESCRIPTION
4	H100192	NUT BARREL WH 5/16x7/8 BLK
4	H100199	WASHER LOCK EXT 12x19 BLK
4	H100396	BOLT WH 5/16x1/2 BLK

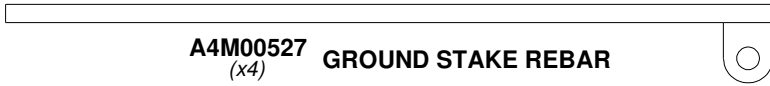

NOTE:
TAP IN GROUND STAKES AT AN APPROXIMATE 45° ANGLE AT LOCATIONS SHOWN. USING GROUND STAKE AS A GUIDE, DRILL 3/8" [10mm] DIA HOLES FOR HARDWARE.

TOP VIEW

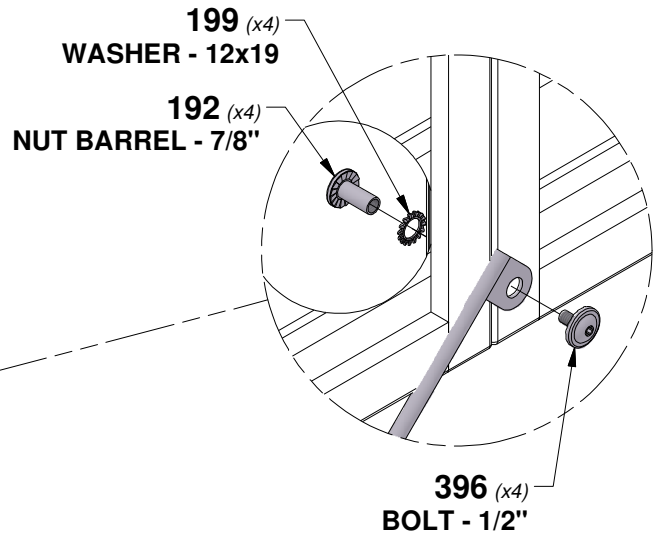
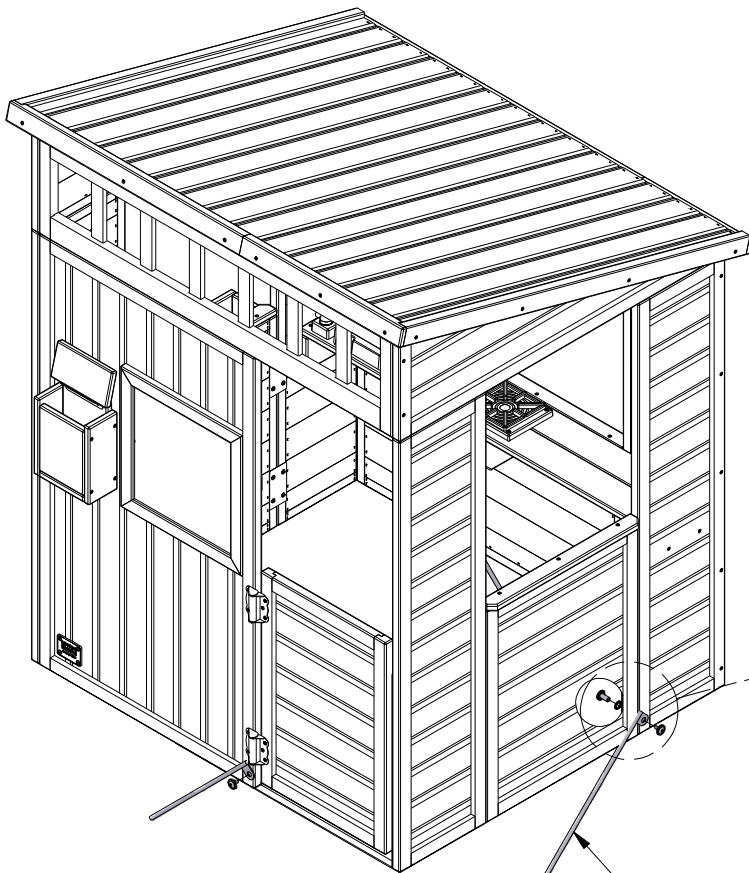
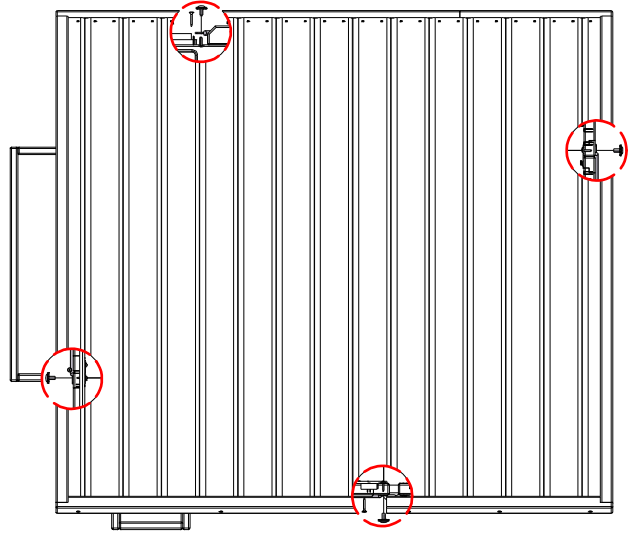

527 *(x4)*
GROUND STAKE REBAR