



INSTALLATION SERVICES AVAILABLE!*

Need a helping hand?

Let our team of professionals handle the installation for you!

GOCONFIGURE
888-888-5424

*Installation services are only available to U.S. customers.

average 2 person assembly time



assembly time may vary based on skill level

For the most up to date assembly manual,
to register your set, or to order replacement parts please visit
www.backyarddiscovery.com

SAVE THIS ASSEMBLY MANUAL FOR FUTURE REFERENCE IN THE EVENT THAT YOU NEED TO ORDER REPLACEMENT PARTS.



GOCONFIGURE
Putting it all together for you

INSTALLATION SERVICES AVAILABLE!*

Need a helping hand?

Let our team of professionals handle the installation for you!

GOCONFIGURE
888-888-5424

**Installation services are only available
to U.S. customers.*

With Go Configure, we bring you 18 years of experience right to your doorstep. We service a wide array of indoor and outdoor recreation products that most consumers don't have the time or ability to deliver & install themselves.

We do the heavy lifting, so you don't have to!

- 18+ Years of Experience Servicing Big Box Retailers and Direct Consumers
- Highly Skilled, Specialized, Courteous, Professional Service Technicians
- Over 140,000 Installations Annually
- White Glove Service

- Satisfaction Guarantee
- Flexible Appointments, including weekends
- Coverage across the nation

Visit www.goconfigure.com for more info!

**Installation services are only available to U.S. customers.*



The store where you made your purchase does not stock parts for this item.

If you have assembly questions or you are missing or have damaged parts, please call

1-800-856-4445

you can also visit www.backyarddiscovery.com
or e-mail customerservice@backyarddiscovery.com

Please have the following information ready when you make your call:

- Model Number of the product located on the front of the assembly manual
 - Description of the part from the parts list
-
- Read entire assembly manual, paying special attention to the important tips and safety information.
 - Ensure there are no missing pieces by first separating and identifying all parts.
 - Make sure to check packing material for small parts that may have fallen out during shipment.
 - Structures are not intended for public use. The Company does not warranty any of its residential structures subjected to commercial use such as: Daycare, Preschool, Nursery School, Recreational Park, or any similar Commercial Application.
 - This manual contains helpful information concerning assembly preparation, installation procedure and required maintenance.
 - Always keep safety in mind as your structure is being built.
 - Keep these instructions for future reference.



Please read entire booklet completely before beginning the assembly process

Please retain these instructions and your receipt for future reference. Keep them in a safe place where you can refer to them as needed. In order to provide you with the most efficient service, it is required that you provide us with the part numbers when ordering parts.

For Your Records:

Please take time and fill out the information below. This information will be needed for warranty issues.

Where Purchased: _____
 Date of Purchase: _____
 Installation Date: _____
 Installed by: _____
 Tracking Number: _____

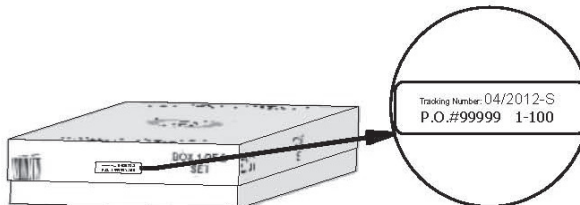
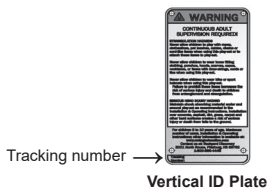

Tracking Number Reference Label

Tracking ID number on the carton and on the bottom of the vertical ID plate are included for tracking purposes associated with warranty claims.

This Limited Warranty by Backyard Discovery applies to products manufactured under the Backyard Discovery brand or its other brands including but not limited to Backyard Botanical, Adventure Playsets, and Leisure Time Products.

Backyard Discovery warrants that this product is free from defect in materials and workmanship for a period of one (1) year from the original date of purchase. This one (1) year warranty covers all parts including wood, hardware, and accessories. All wood carries a five (5) year pro-rated warranty against rot and decay. Refer to the schedule below for charges associated with replacement of parts under this Limited Warranty. In addition, Backyard Discovery will replace any parts within the first 30 days from date of purchase found to be missing from or damaged in the original packaging.

This warranty applies to the original owner and registrant and is non-transferable. Regular maintenance is required to assure maximum life and performance of this product. Failure by the owner to maintain the product according to the maintenance requirements may void this warranty. Maintenance guidelines are provided in the Owner's Manual.

This Limited Warranty does not cover:

- Labor for any inspection
- Labor for replacement of any defective item(s)
- Incidental or consequential damages
- Cosmetic defects which do not affect performance or integrity of a part or the entire product
- Vandalism, improper use, failure due to loading or use beyond the capacities stated in the applicable Assembly Manual.
- Acts of nature including but not limited to wind, storms, hail, floods, excessive water exposure
- Improper installation including but not limited to installation on uneven, unlevel, or soft ground
- Minor twisting, warping, checking, or any other natural occurring properties of wood that do not affect performance or integrity

Backyard Discovery products have been designed for safety and quality. Any modifications made to the original product could damage the structural integrity of the unit leading to failure and possible injury. Modification voids any and all warranties and Backyard Discovery assumes no liability for any modified products or consequences resulting from failure of a modified product.

This product is warranted for RESIDENTIAL USE ONLY. Under no circumstance should a Backyard Discovery product be used in public settings. Such use may lead to product failure and potential injury. Any and all public use will void this warranty. Backyard Discovery disclaims all other representations and warranties of any kind, express or implied.

Pro Rated Part Replacement Schedule

<u>Product Age</u>	<u>Customer Pays</u>
All Parts	
0-30 days from date of purchase	\$0 and free shipping
31 days to 1 year	\$0 + S&H
Wood Rot and Decay Only	
1 year	\$0 and free shipping
2 year	20% + S&H
3 year	40% + S&H
4 year	60% + S&H
5 year	80% + S&H
Over 5 years	100% + S&H



NOTE:

Your Children's Safety Is Our #1 Concern!

Observe the following statements and warnings to reduce the likelihood of serious or fatal injury. Please review these safety rules regularly with your children.



WARNING: BURN HAZARD

- Pay special attention to plastic and metal surfaces as they may be hot enough to cause burns.
- Always check the temperature of the product before letting your children play on it.
- Remember that the product may cause burns if left in direct sunlight.
- Always be aware of the sun and weather conditions, and do not assume that the equipment is safe because the air temperature is not very high.

- Children **MUST NOT** use this playcenter until unit has been completely assembled and inspected by an adult to ensure set has been properly installed and anchored.
- Equipment is recommended for use by children 3 to 10 years of age.
- This Playcenter is designed for a specific number of occupants whose combined weight should not exceed the designated weight on the elevated floor or the swing area. The total unit capacity is outlined in the Basic Setup Dimensions section of instruction manual. The maximum fall height and recommended play area is also available in the Basic Setup Dimensions section of the manual.
- On-site, continuous adult supervision is **REQUIRED. MOST SERIOUS INJURIES AND DEATHS ON PLAYGROUND EQUIPMENT HAVE OCCURRED WHILE CHILDREN WERE UNSUPERVISED!**
- **DO NOT** allow children to walk close to, in front of, behind, or between moving swings or other moving playground equipment.
- **DO NOT** let children stand on swings.
- Children should **NOT** twist the chains and ropes and should not loop them over the top support bar, this could reduce the strength of the chain or rope.
- **DO NOT** let children push empty seats. The seat could hit them and cause serious injury.
- Instruct and teach children to sit in the center of the swings with their full weight on the seats.
- **DO NOT** allow children to use the equipment in a manner other than intended.
- Instruct children **NOT** to get off equipment while it is in motion.
- Instruct children to **ALWAYS** go down slides feetfirst. Never slide headfirst.
- Instruct children to **LOOK** before they slide to make sure no one is at the bottom.
- **DO NOT** allow children to run up a slide, as this increases their chances of falling.
- **DRESS CHILDREN APPROPRIATELY.** (Examples would include wearing well-fitting shoes and the avoidance of ponchos, scarfs, and other loose-fitting clothing that is potentially hazardous while using equipment).
- **DO NOT** allow children to climb when the equipment is wet.
- Children should **NEVER** jump from a fort deck. They should always use the ladder, ramp or slide.
- Children should **NEVER** be allowed to crawl or walk across the top of monkey bars.
- **DO NOT** allow children to crawl on top of a fort roof.
- Verify that any suspended climbing ropes, chain, or cable are secured at both ends and that they cannot be looped back on themselves as to create an entanglement hazard.
- **DO NOT** let children attach items to the playground equipment that are not specifically designed for use with the equipment. Items such as, but not limited to, jump ropes, clothesline, pet leashes, cables and chain can cause a strangulation hazard.
- Children should **NEVER** wrap their legs around swing chain.
- **DO NOT** allow children to slide down the swing chain.
- Instruct children to remove their bike or other sports helmet before playing on playground equipment.
- **NEVER** add extra length to chain or rope. The chains or ropes provided are the maximum length designed for the swinging element(s).

Modifications

- Modifications made by the consumer to the original activity toy shall be carried out according to the instructions of the manufacturer. In particular, instructions shall be provided with kit/accessory about the installation of rope/nets concerning the minimum diameter, the need for fixation at both ends, overall length, and positioning in relation to other structures.



Positioning Your Playcenter

- The playcenter is designed to be installed on a level surface by an adult with an adult helper. Place in a flat area of your yard to minimize ground preparation.
- Choose a level location for the equipment. This can reduce the likelihood of the play set tipping over and loose-fill surfacing material washing away during heavy rains.
- Place the equipment not less than 6'-7" (2.0 m) from any structure or obstruction such as a fence, garage, house, overhanging branches, laundry lines, or electrical wires.
- Provide enough room so that the children can use the equipment safely. For example, for structures with multiple play activities, a slide should not exit in front of a swing.
- It is a good idea to place your playcenter in an area that is convenient for adults to watch children at play.
- Create a site free of obstacles that could cause injuries – such as low overhanging tree branches, overhead wires, tree stumps and/or roots, large rocks, bricks and concrete. Additional suggestions in the Suggested Playground Surfacing Section.
- Do not build your playset on top of surfacing material.
- Locate bare metal platforms and slides out of direct sunlight to reduce the likelihood of serious burns. A slide that faces north will receive the least direct sunlight.
- Separate active and quiet activities from each other. For example, locate sandboxes away from swings or use a guardrail or barrier to separate the sandbox from the movement of the swings.

Suggested Playground Surfacing

- Do not install home playground equipment over concrete, asphalt, packed earth, grass, carpet, or any other hard surface. A fall onto a hard surface can result in serious injury to the equipment user.
- Do not install loose fill surfacing over hard surfaces such as concrete or asphalt.
- Shredded bark mulch, wood chips, fine sand and fine gravel, are added as shock absorbing materials after assembly. If used properly these materials can absorb some of the impact of a child's fall.
- All surface material should extend a minimum of 6'-7" (2.0 m) feet in all directions around the play area.
- Do not apply playground surfacing until after the unit is completely constructed. Playset should not be built on top of surfacing.
- Use containment, such as digging out around the perimeter and/or lining the perimeter with landscape edging.
- Installations of rubber tiles or poured-in-place surfaces (other than loose-fill materials) generally require a professional and are not "do-it-yourself" projects.
- Shall use Playground Surfacing Materials (other than loose-fill material) which comply with the safety standard ASTM F1292 Standard Specification of Impact Attenuation of Surfacing Materials within the Use Zone of Playground Equipment.
- Anchors shall be placed as instructed to reduce tipping hazards.

The following chart explains the fall height in feet from which a life threatening head injury would not be expected

Critical Heights in feet (m) of Tested Materials

Material	Uncompressed Depth			Compressed Depth to 9" (228mm)
	6" (152mm)	9" (228mm)	12" (304mm)	
Wood Chips	7' (2.13m)	10-12' (3.0-3.6m)	11' (3.35m)	10' (3.05m)
Double-Shredded Bark Mulch	6' (1.83m)	10-12' (3.0-3.6m)	11' (3.35m)	7' (2.13m)
Engineered Wood Fibers	6' (1.83m)	7' (2.13m)	>12' (3.66m)	6' (1.83m)
Fine Sand	5' (1.52m)	5' (1.52m)	9' (2.74m)	5' (1.52m)
Coarse Sand	5' (1.52m)	5' (1.52m)	6' (1.83m)	4' (1.22m)
Fine Gravel	5' (1.52m)	7' (2.13m)	10' (3.05m)	6' (1.83m)
Medium Gravel	5' (1.52m)	5' (1.52m)	6' (1.83m)	5' (1.52m)
Shredded Tires*	10-12' (3.0-3.6m)	N/A	N/A	N/A

*This data is from tests conducted by independent testing laboratories on a 6-inch depth of uncompressed shredded tire samples produced by four manufacturers. The tests reported critical heights, which varied from 10 feet to greater than 12 feet. It is recommended that persons seeking to install shredded tires as a protective surface request test data from the supplier showing the critical height of the material when it was tested in accordance with ASTM F1292.



APPENDIX A

The following information is from the United States Consumer Product Safety Commission's Information Sheet for playground surfacing material; also see the following website for additional information: www.cpsc.gov

X3. SECTION 4 OF THE CONSUMER PRODUCT SAFETY COMMISSION'S OUTDOOR HOME PLAYGROUND SAFETY HANDBOOK⁹

X3.1 Select Protective Surfacing—One of the most important things you can do to reduce the likelihood of serious head injuries is to install shock-absorbing protective surfacing under and around your play equipment. The protective surfacing should be applied to a depth that is suitable for the equipment height in accordance with ASTM Specification F 1292. There are different types of surfacing to choose from; whichever product you select, follow these guidelines:

X3.1.1 Loose-Fill Materials:

X3.1.1.1 Maintain a minimum depth of 9 inches of loose-fill materials such as wood mulch/chips, engineered wood fiber (EWF), or shredded/recycled rubber mulch for equipment up to 8 feet high; and 9 inches of sand or pea gravel for equipment up to 5 feet high. NOTE: An initial fill level of 12 inches will compress to about a 9-inch depth of surfacing overtime. The surfacing will also compact, displace, and settle, and should be periodically refilled to maintain at least a 9-inch depth.

X3.1.2 Use a minimum of 6 inches of protective surfacing for play equipment less than 4 feet in height. If maintained properly, this should be adequate. (At depths less than 6 inches, the protective material is too easily displaced or compacted.)

NOTE: Do not install home playground equipment over concrete, asphalt, or any other hard surface. A fall onto a hard surface can result in serious injury to the equipment user. Grass and dirt are not considered protective surfacing because wear and environmental factors can reduce their shock absorbing effectiveness. Carpeting and thin mats are generally not adequate protective surfacing. Ground level equipment such as a sandbox, activity wall, playhouse or other equipment that has no elevated play surface – does not need any protective surfacing.

X3.1.3 Use containment, such as digging out around the perimeter and/or lining the perimeter with landscape edging. Don't forget to account for water drainage.

X3.1.3.1 Check and maintain the depth of the loose-fill surfacing material. To maintain the right amount of loose-fill materials, mark the correct level on play equipment support posts. That way you can easily see when to replenish and/or redistribute the surfacing.

X3.1.3.2 Do not install loose-fill surfacing over hard surfaces such as concrete or asphalt.

X3.1.4 Poured-In-Place Surfaces or Pre-Manufactured Rubber Tiles — You may be interested in using surfacing other than loose-fill materials – like rubber tiles or poured-in-place surfaces.

X3.1.4.1 Installations of these surfaces generally require a professional and are not “do-it-yourself” projects.

X3.1.4.2 Review surface specification before purchasing this type of surfacing. Ask the installer/manufacture for a report showing that the product has been tested to the following safety standard: ASTM F 1292 Standard Specification for Impact Attenuation of Surfacing Materials within the Use Zone of Playground Equipment. This report should show the specific height for which the surface is intended to protect against serious head injury. This height should be equal to or greater than the fall height – vertical distance between a designated play surface (elevated surface for standing, sitting, or climbing) and the protective surfacing below – of your play equipment

X3.1.4.3 Check the protective surfacing frequently for wear.

X3.1.5 Placement — Proper placement and maintenance of protective surfacing is essential. Be sure to:

X3.1.5.1 Extend surfacing at least 6 feet from the equipment in all directions.

X3.1.5.2 For to-fro swings, extend protective surfacing in front of and behind the swing to a distance equal to twice the height of the top bar from which the swing is suspended.

⁹This information has been extracted from the CPSC publications “Playground Surfacing — Technical Information Guide” and “Handbook for Public Playground Safety.” Copies of these reports can be obtained by sending a postcard to the: Office of Public Affairs, U.S. Consumer Product Safety Commission, Washington, D.C., 20207 or call the toll-free hotline: 1-800-638-2772.

The American Society for Testing and Materials takes no position respecting the validity of any parent right asserted in connection with any item mentioned in this standard. Users of this standard are expressly advised that determination of the validity of any such parent rights, and the risk of infringement of such rights, are entirely their own responsibility.

The standard is subject to revision at any time by the responsible technical committee and must be reviewed every five years and if not revised, either approved or withdrawn. Your comments are invited either for revision of this standard or for additional standards and should be addressed to ASTM Headquarters. Your comments will receive careful consideration at a meeting of the responsible technical committee, which you may attend. If you feel that your comments have not received a fair hearing you should make your views known to the ASTM Committee on Standards. 100 Barr Harbor Drive, West Conshohocken, PA 19428.



IT IS IMPORTANT TO CHECK AND TIGHTEN ALL HARDWARE AT THE BEGINNING AND DURING THE SEASON AS THEY MAY LOOSEN DUE TO WOOD EXPANSION AND CONTRACTION.

At the beginning of each play season

- Tighten all hardware.
- Lubricate all metallic moving parts per manufacturer's instructions.
- Check all protective coverings on bolts, pipes, edges, and corners. Replace if they are loose, cracked, or missing.
- Check all moving parts including swing seats, ropes, cables, and chains for wear, rust, or other deterioration. Replace as needed.
- Check metal parts for rust. If found, sand and repaint using a non lead-based paint meeting the requirements of 16 CFR 1303.
- Check all wood members for deterioration and splinters. Sand down splinters and replace deteriorating wood members.
- Reinstall any plastic parts, such as swing seats or any other items that were removed for the cold season.
- Rake and check depth of loose fill protective surfacing materials to prevent compaction and to maintain appropriate depth. Replace as necessary.

Twice a month during play season

- Tighten all hardware.
- Check all protective coverings on bolts, pipes, edges, & corners. Replace if they are loose, cracked, or missing.
- Rake and check depth of loose fill protective surfacing materials to prevent compaction and to maintain appropriate depth. Replace as necessary.

Once a month during play season.

- Lubricate all metallic moving parts per manufacturer's instructions.
- Check all moving parts including swing seats, ropes, cables, and chains for wear, rust, or other deterioration. Replace as needed.

At the end of each season or when the temperature drops below 32° F

- Remove plastic swing seats and other items as specified by the manufacturer and take indoors or do not use.
- Rake and check depth of loose fill protective surfacing materials to prevent compaction and to maintain appropriate depth. Replace as necessary.

Additional Maintenance

- Check the swing beam and hardware every two weeks due to wood expansion and contraction. It is particularly important that this procedure be followed at the beginning of each season.
- Inspect wood parts monthly. The grain of the wood sometimes will lift in the dry season causing splinters to appear. Light sand may be necessary to maintain a safe playing environment. Treat your playset with stain regularly, to help prevent severe checking/splitting and other weather damage.
- A waterborne transparent stain has been applied to your playset. This is done for color only. Once or twice a year, depending on your climate conditions, you must apply some type of protection (sealant) to the wood of your unit. Prior to the application of sealant, lightly sand any "rough" spots on your playset. Please note this is a requirement of your warranty.
- Assembling and maintaining the playset on a level location is very important. As your children play, your playset will slowly dig its way into the soil, and it is very important that it settles evenly. Make sure the playset is level and true one each year or at the beginning of each play season.

Disposal Instructions

When the Playcenter use is no longer desired, it should be disassembled and disposed of in such a way that no unreasonable hazards will exist at the time the unit is discarded.



Third Party Assembly

- Customer may, in their sole discretion, elect to use a third party person or service to assemble this product. Backyard Discovery assumes no responsibility or liability for any charge incurred by the Customer for any assembly services. Please see our warranty for more information about damaged and missing part replacement coverage. Backyard Discovery will not reimburse Customer for the price of parts purchased.
- Modifications made by the consumer to the original activity toy shall be carried out according to the instructions of the manufacturer. In particular, instructions shall be provided with kit/accessory about the installation of rope/nets concerning the minimum diameter, the need for fixation ends, overall length, and positioning in relation to other at both structures.

OWNERS SHALL BE RESPONSIBLE FOR MAINTAINING THE LEGIBILITY OF THE WARNING LABELS



Protrusion Hazard

Incorrect

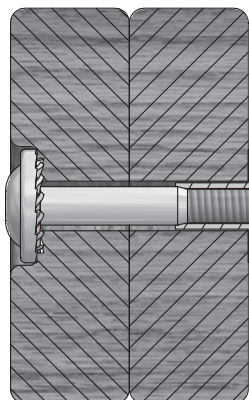

If you see exposed threads and your bolt protrudes beyond the T-Nut you may have over tightened the bolt or used incorrect hardware. If you've overtightened, remove the bolt and add washers to eliminate the protrusion.

Correct

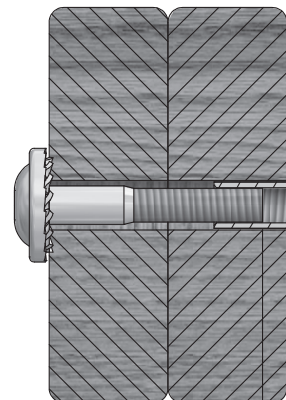

1/8"

Proper Hardware Assembly

Bolt and T-Nut Assembly

Tap T-nut into the provided hole. Insert your bolt through the lock washer and insert into the provided hole opposite from the T-Nut. Turn clockwise to thread into T-nut. Do not completely tighten until instructed.

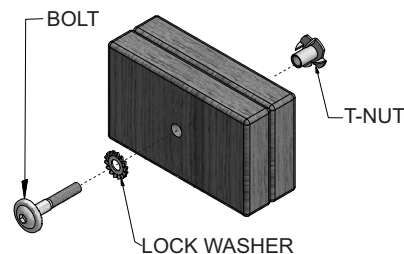

Bolt and Barrel Nut Assembly

Insert barrel nut through the lock washer and press the pair through the provided hole. Insert your bolt through the second lock washer and insert the pair into the provided hole opposite from the barrel nut. Turn clockwise to thread into the barrel nut. Do not completely tighten until instructed.

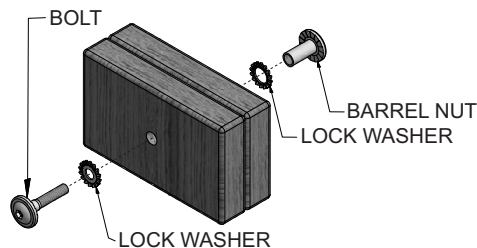

Lag Assembly

Normally there will be a pre-drilled pilot hole on assemblies that require a Lag Screw. If there is no pilot hole, line up the two boards as they are to be attached and use the factory drilled hole as a guide to drill another pilot hole into the adjoining board. This will keep the wood from splitting. Only a lock washer is required for steps with Lag Screws.

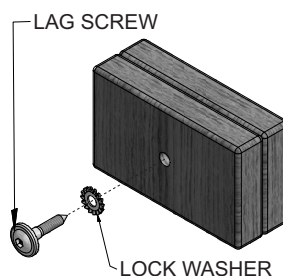



ASSEMBLY TIP:

Keep an eye out for these boxes which will contain helpful pictures and information making the assembly process as quick and painless as possible.

Sorting Hardware

NUT BARREL
H100545

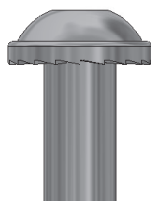

SCREW
H100695



T-NUT
H100699

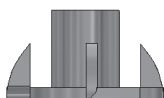

WASHER FLAT
H100706

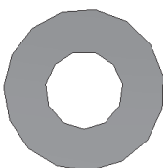

BOLT HEX
H100716

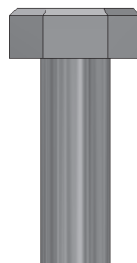

BOLT
H100718



SCREW PWH
H100742

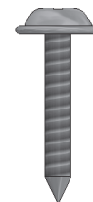

To help with assembly we recommend sorting your hardware bags with the seven digit alpha-numeric number printed on the bags or by hardware type (i.e. bolts, nuts, etc.). Organizing your hardware will make assembly easier.

Hardware Identification

Hardware bags are printed with a seven digit alpha-numeric part number. During assembly you only need to reference the last three digits of the part number as noted in each step. This will make finding the correct hardware easier.

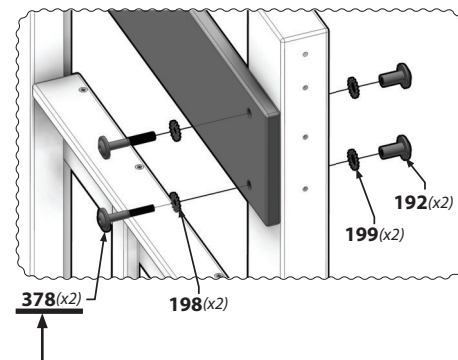
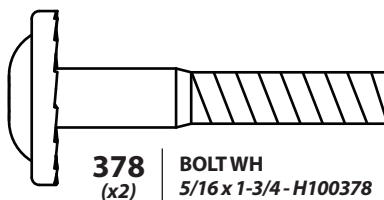

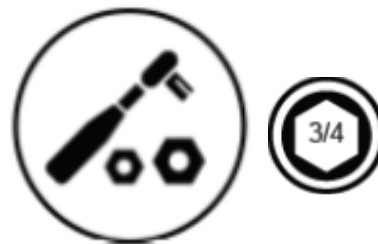
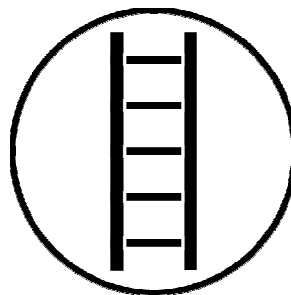
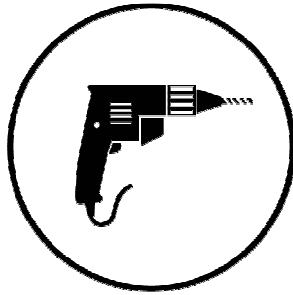
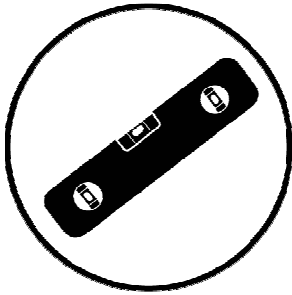
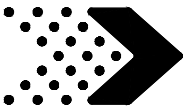

Icons and their uses you will see throughout this manual



You will need to make sure that your assembly is square before tightening your bolts.



When you see this icon you will need a socket wrench. The icons below show the size of attachments needed for assembly.



For proper assembly you will need to ensure that your structure is level before proceeding to the next step.



This icon warns you to not over tighten your bolts. This is to prevent structural damage and also splintering your wood.



Some steps in the assembly process will require an extra set of hands. Make sure you have a helper available.



This icon will show you what drill attachments are needed. For this example you will need a Phillips head attachment, 1/4 driver, and 1/8 drill bit.



This icon shows the size of an open ended wrench. Using the wrench as the fraction bar.



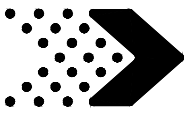

Selecting the correct location for your play product is important for your children's safety and the product's longevity.

- The safe play area refers to a zone extending 6 ft 7 in. [2.0m] beyond the play product, including the space above the play product.

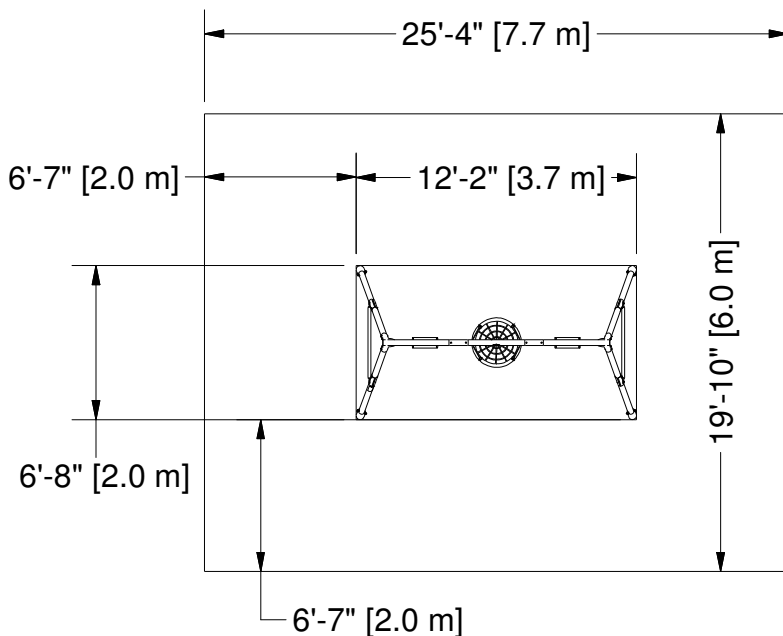
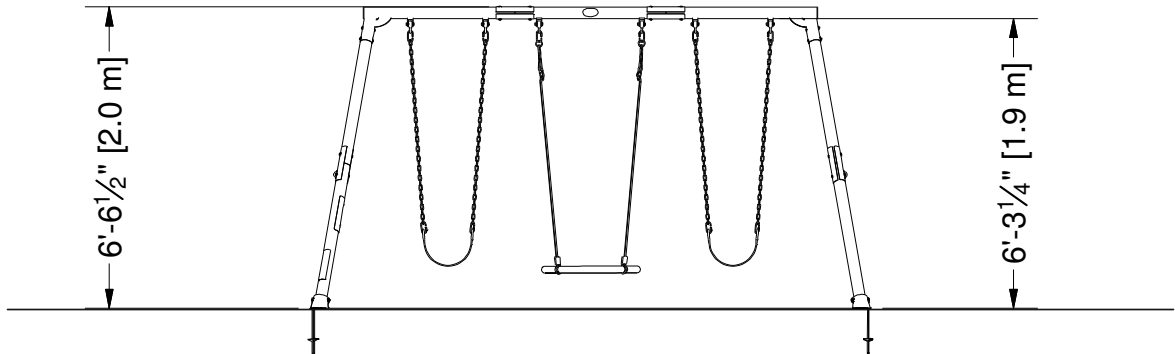

Ground Dimension

12'-2" (3.7m) x 6'-8" (2.0m)

Safe Play Area

25'-4" (7.7m) x 19'-10" (6.0m)

Fall Height

6' - 3 1/4" (1.9m)

General Information:

Your set has been designed and engineered for children only and for residential use only. A maximum of 150 lbs. per child is recommended for all play activities. A maximum of 3 children is recommended for this swing set.

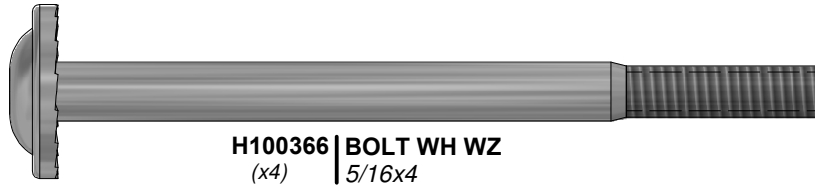
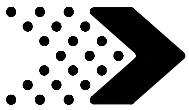

H100366 | BOLT WH WZ
(x4) | 5/16x4

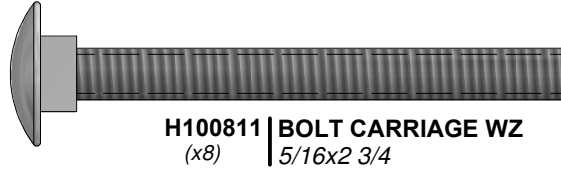

H100811 | BOLT CARRIAGE WZ
(x8) | 5/16x2 3/4



H100591 | BOLT CARRIAGE WZ
(x12) | 5/16x2 1/2

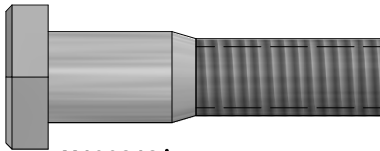

H100818 | BOLT HEX WZ
(x6) | M12x 45mm



H100832 | BOLT PTH
(x4) | 1/4x3/4



H100831 | NUT BARREL PTH BLK
(x4) | 1/4x3/4

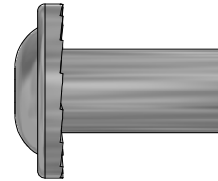

H100499 | NUT BARREL WH WZ
(x24) | 5/16x7/8



H100819 | LOCK NUT WZ
(x6) | M12

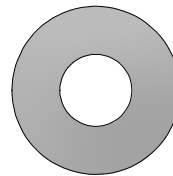

H100278 | WASHER FLAT WZ
(x4) | 5/16

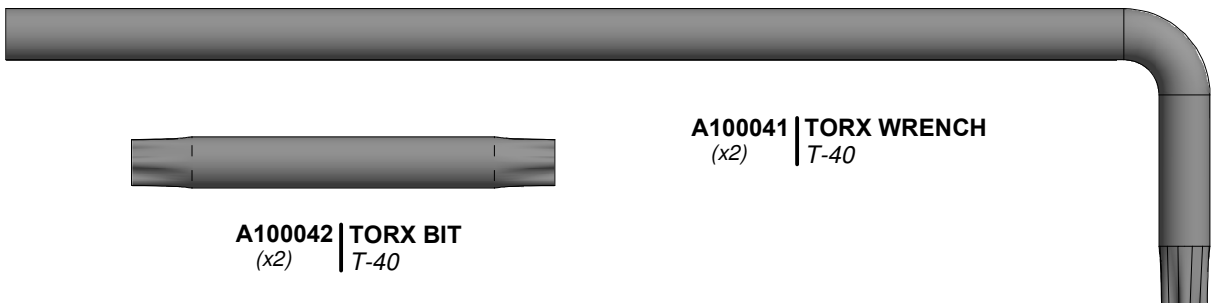

A100041 | TORX WRENCH
(x2) | T-40

A100042 | TORX BIT
(x2) | T-40

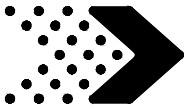

A4M01013 | BOTTOM LEG
(x4)



A4M01015 | TOP LEG
(x4)



A4M01016 | MIDDLE TOP BEAM
(x1)



A4M01018 | SIDE BAR
(x2)

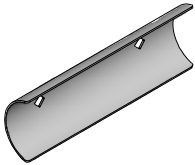

A4M01019 | METAL BRACKET GREY
(x8)



A4M01020 | LEG CONNECTING TUBE
(x4)



A4M01024 | METAL BRACKET GREEN
(x4)



A4M01021 | SIDE TOP BEAM
(x2)



A4M01022 | TOP BEAM CONNECTING TUBE
(x2)

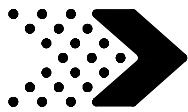

A6P00435 | WARNING LABEL STICKER
(x1)

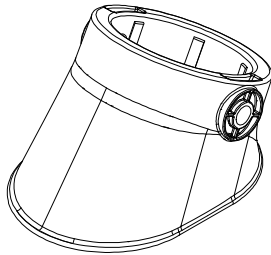
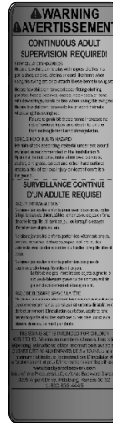

A6P00366 | SWING SET FOOT
(x4)



A6P00375 | BYD TAG STICKER (SMALL)
(x1)

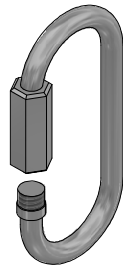

H100242 | QUICK LINK (LONG) WZ
(x10)

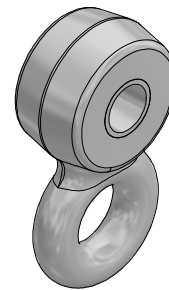

A4M01040 | DUCTILE HANGER WZ
(x6)



A4M01136 | CHAIN GREEN 48.25"
(x4)

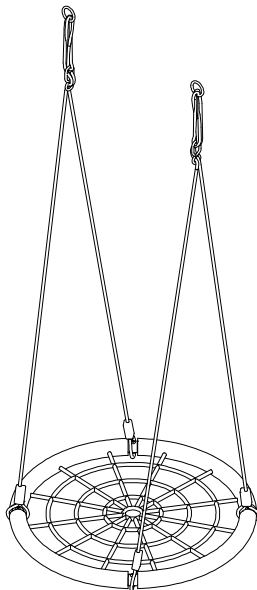

A4M01126 | 26" WEB SWING SEAT ROPE
(1)

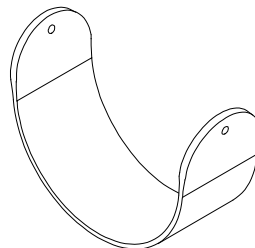

A6P00362 | 26" HD BELT SWING
(x2)



A100178 | AUGER GROUND STAKE
(x4)

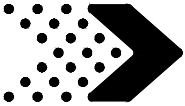

STEP 1



A4M01013
(x4) | **BOTTOM LEG**



A4M01015
(x4) | **TOP LEG**



A4M01020
(x4) | **LEG CONNECTING TUBE**

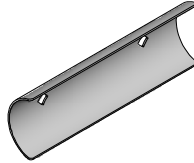

A4M01019
(x8) | **METAL BRACKET GREY**



H100591 | **BOLT CARRIAGE WZ**
(x4) | 5/16x2-1/2



H100811 | **BOLT CARRIAGE WZ**
(x4) | 5/16x2 3/4

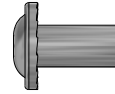

H100499 | **NUT BARREL WH WZ**
(x8) | 5/16x7/8

NOTE: REPEAT THIS STEP 4 TIMES.

TIP: PLACE CARRIAGE BOLT BEFORE NUT BARREL.

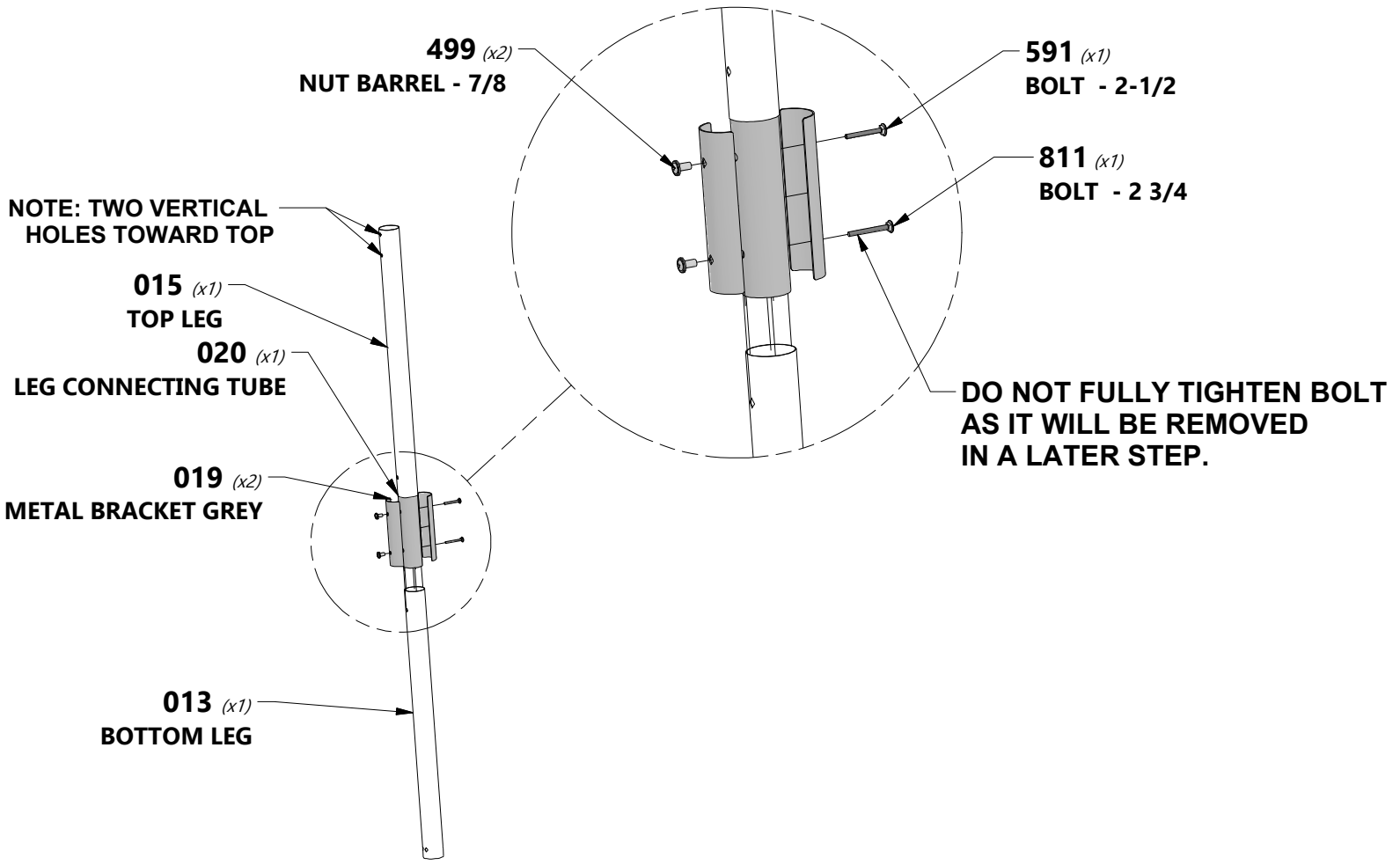



STEP 2



A4M01016 | MIDDLE TOP BEAM
(x1)



A4M01022 | TOP BEAM CONNECTING TUBE
(x2)



A4M01021 | SIDE TOP BEAM
(x2)



A4M01040 | DUCTILE HANGER WZ
(x6)

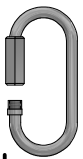

H100242 | QUICK LINK (LONG) WZ
(x6)



A4M01024 | METAL BRACKET GREEN
(x4)



A6P00375 | BYD TAG STICKER (SMALL)
(x1)

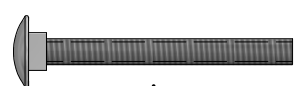

H100811 | BOLT CARRIAGE WZ
(x4) | 5/16x2 3/4

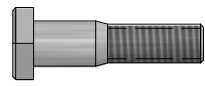

H100818 | BOLT HEX WZ
(x6) | M12x 45mm

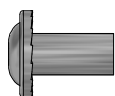

H100499 | NUT BARREL WH WZ
(x4) | 5/16x7/8



H100819 | LOCK NUT WZ
(x6) | M12

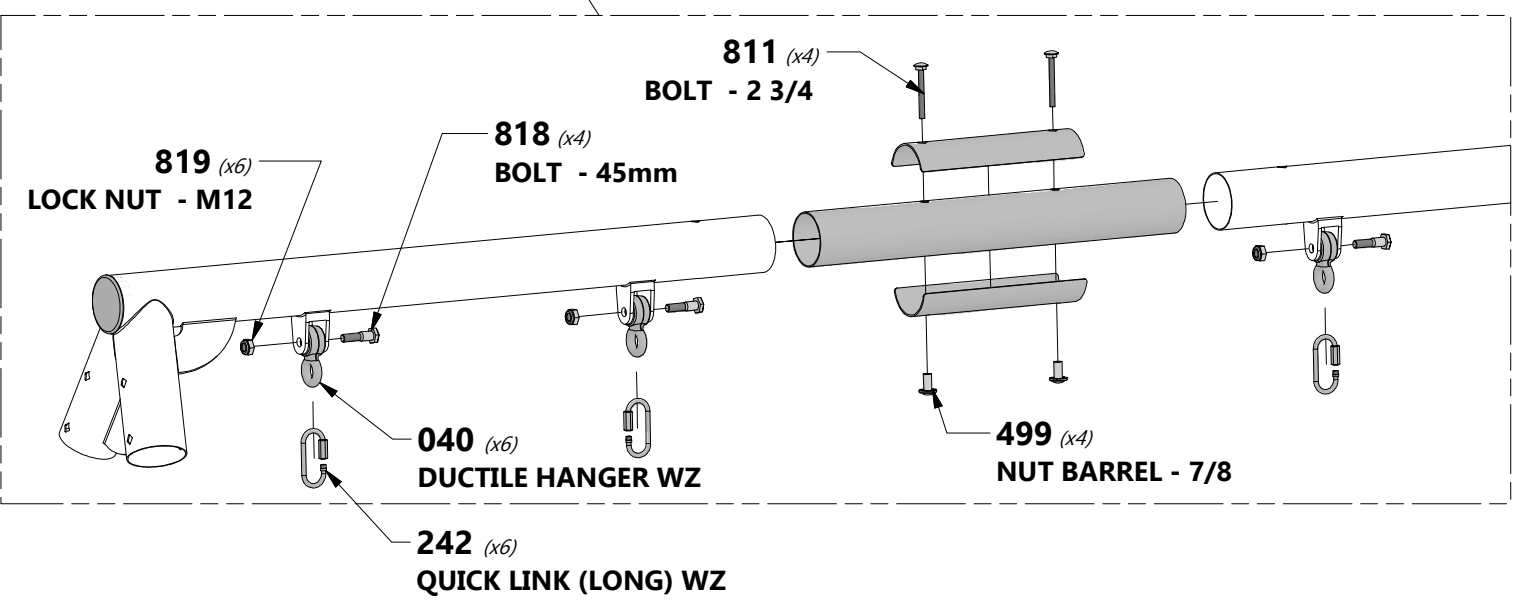
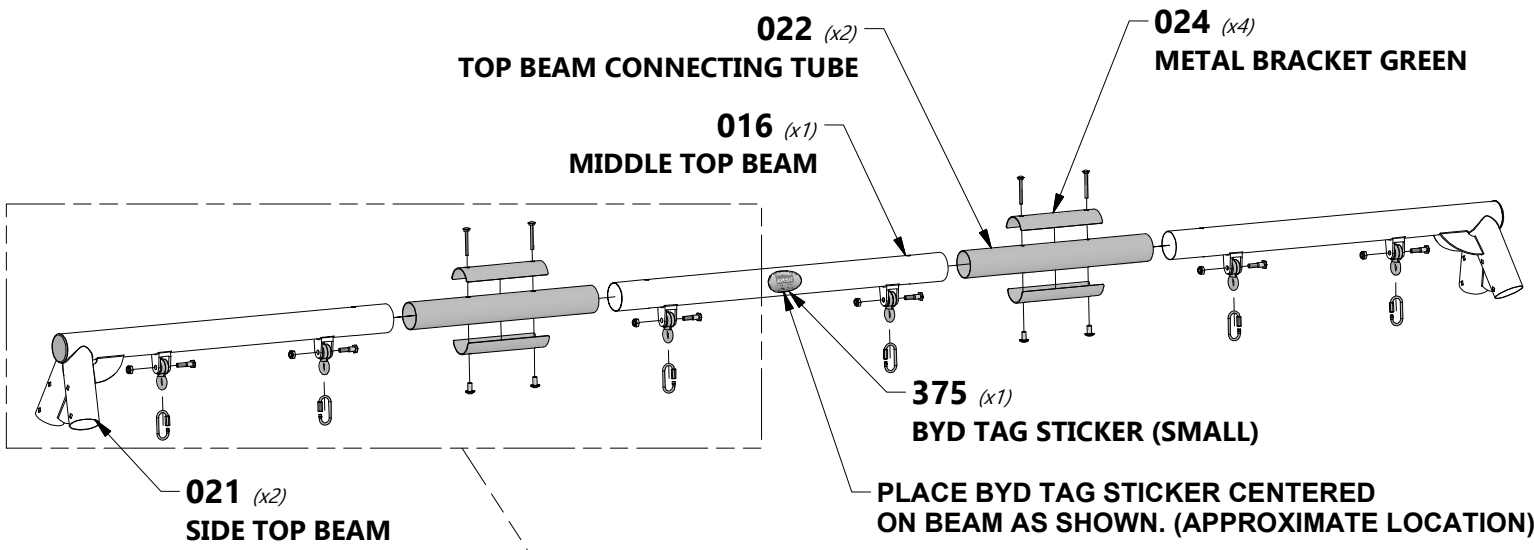

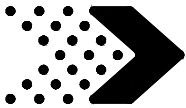

STEP 3

A6P00435 | WARNING LABEL STICKER
(x1)



A4M01018 | SIDE BAR
(x2)



H100591 | BOLT CARRIAGE WZ
(x8) | 5/16x2 1/2

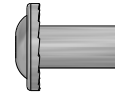

H100499 | NUT BARREL WH WZ
(x8) | 5/16x7/8

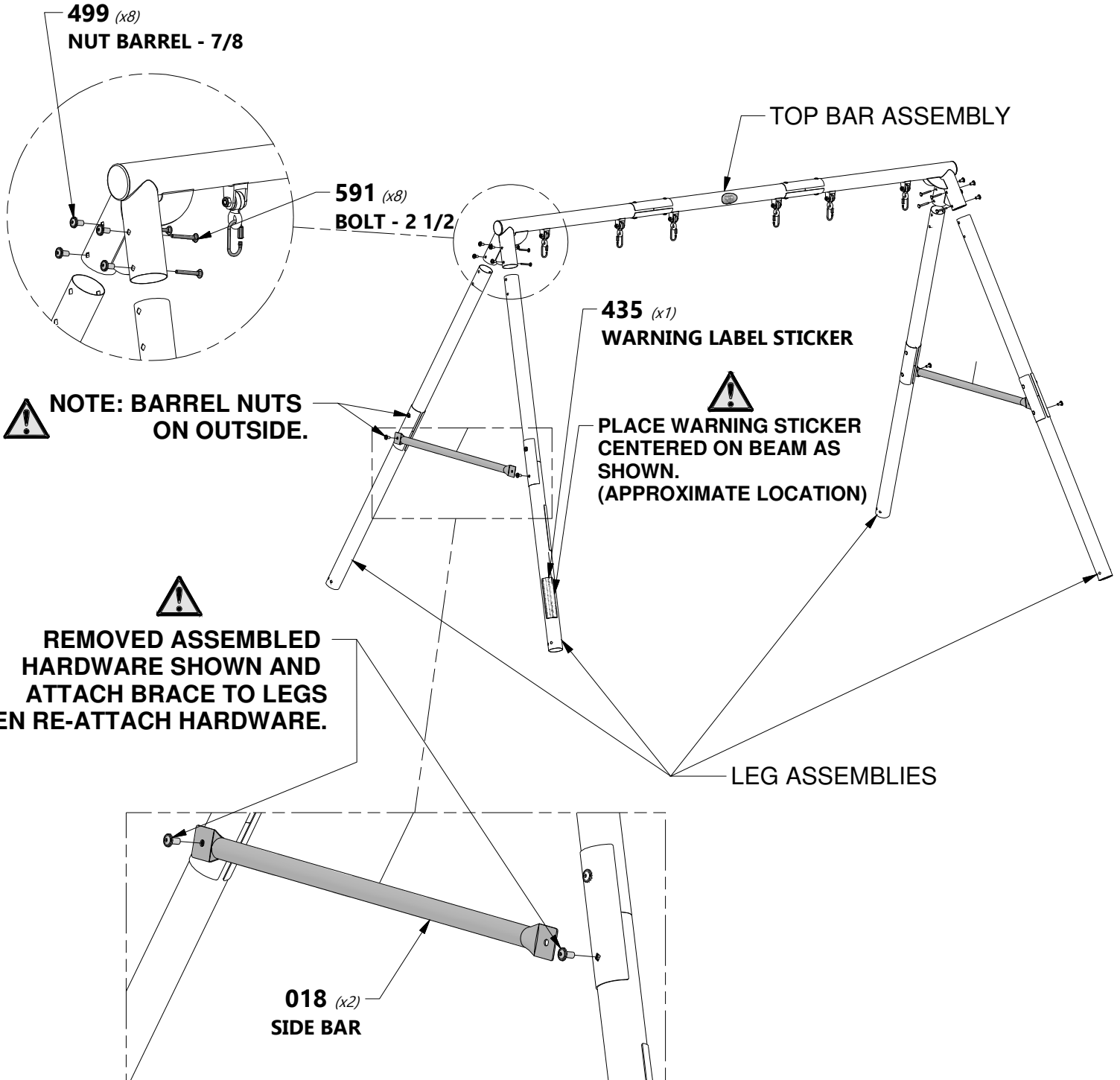



SETUP

WEB SWING

WEB SWING SETUP INSTRUCTIONS:

FOLLOW INSTRUCTIONS BELOW BEFORE USING THE WEB SWING.



H100832 | BOLT PTH
(4) | 1/4x3/4



H100831 | NUT BARREL PTH BLK
(4) | 1/4x3/4



IMPORTANT:
SLIDE ROPE LOOPS OVER TUBE ENDS FIRST!

SLIDE NARROW END OF TUBES INTO LARGER OPENING AFTER SLIDING ROPE LOOPS ONTO TUBES.

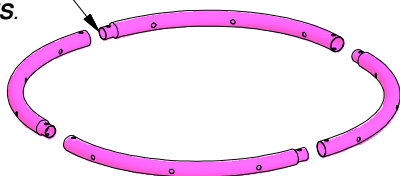

NOTE: ROPE WEBBING NOT SHOWN IN ILLUSTRATION FOR CLARITY.

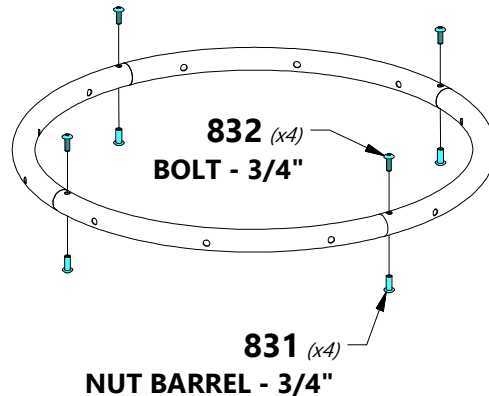

Note: It is important that the web swing hang level.



IMPORTANT

TO ENSURE STRAIGHT SWINGING MOTION, ADJUST BOTH "S" BRACKETS UNTIL WEB SEAT IS LEVEL.



IMPORTANT:

SWING MUST BE SET AT A MINIMUM OF 8 INCHES OFF THE GROUND WHEN INSTALLED.

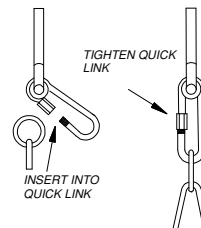
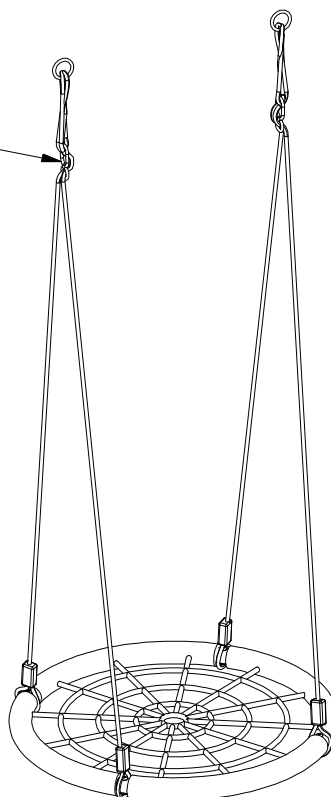

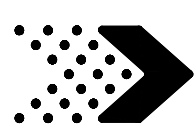

STEP 4

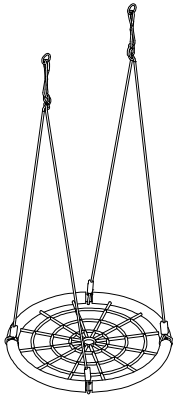

A4M01126 (x1) | **26" WEB SWING SEAT ROPE**

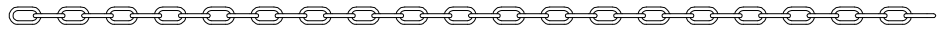

A4M01136 (x4) | **CHAIN GREEN 48.25"**

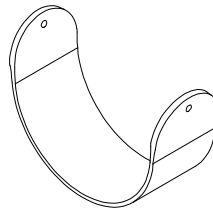

A6P00362 (x2) | **26" HD BELT SWING**



H100242 (x4) | **QUICK LINK WZ**

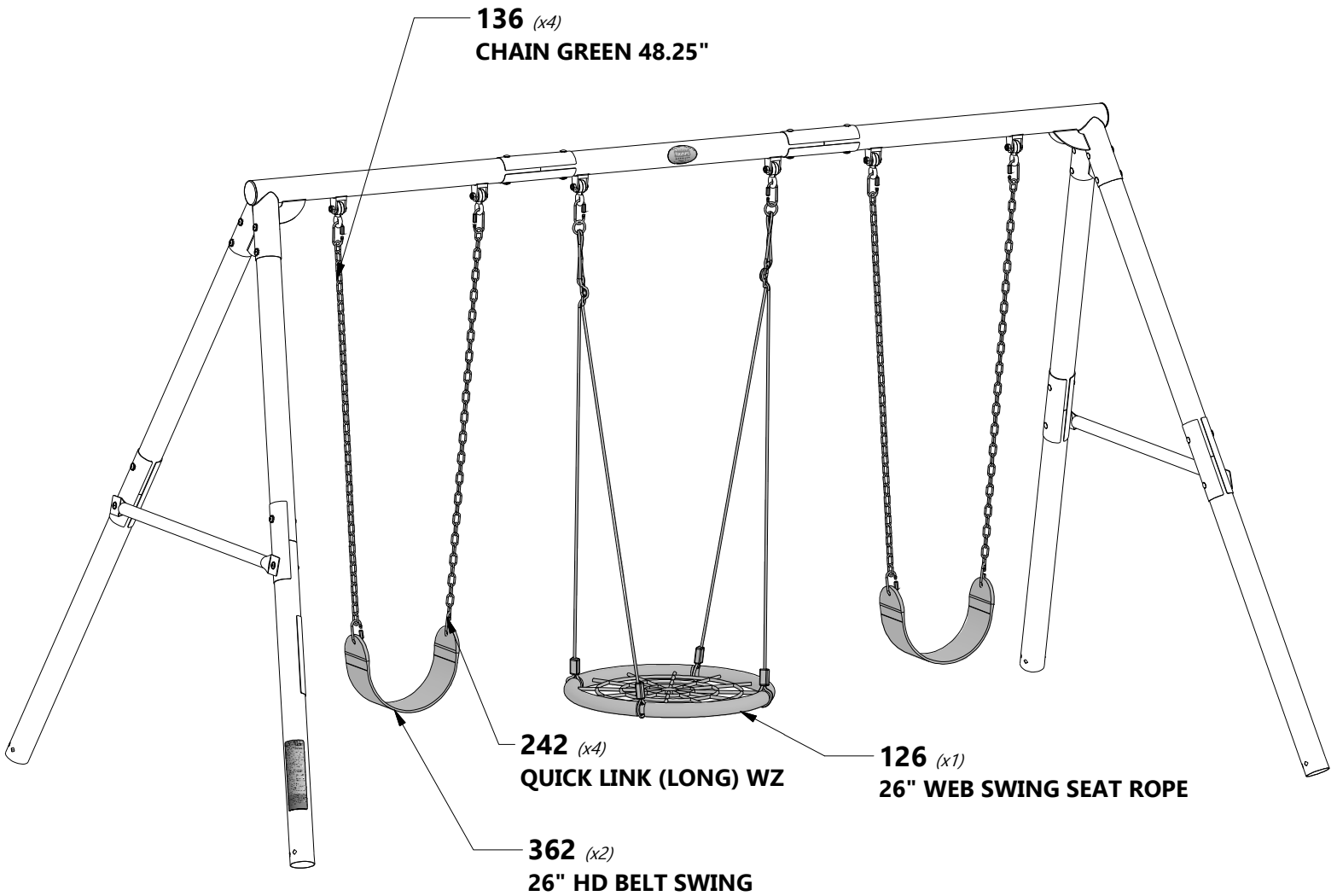

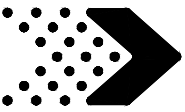

STEP 5

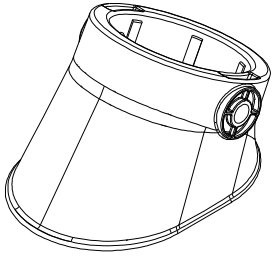

A6P00366 | SWING SET FOOT
(x4)



A100178 | AUGER GROUND STAKE
(x4)



H100366 | BOLT WH WZ
(x4) | 5/16x4



H100278 | WASHER FLAT WZ
(x4) | 5/16

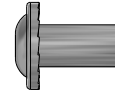

H100499 | NUT BARREL WH WZ
(x4) | 5/16x7/8

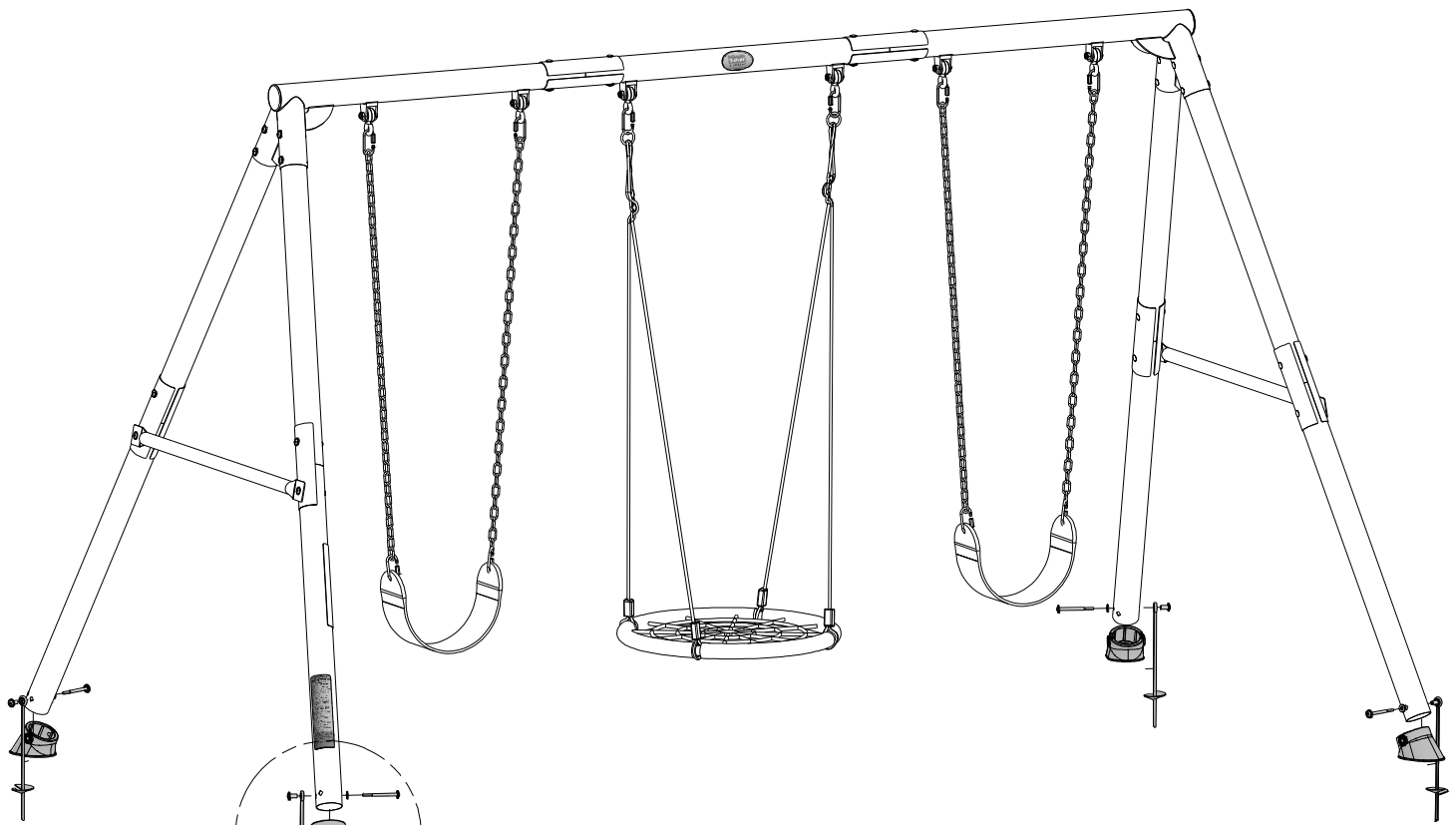

NOTE HOLE ORIENTATION

178 (x4) | AUGER GROUND STAKE

499 (x4) | NUT BARREL - 7/8

366 (x4) | BOLT - 4

278 (x4) | WASHER FLAT - 5/16

366 (x4) | SWING SET FOOT