



Fabricado por:  
 Backyard Discovery  
 3305 Airport Drive, Pittsburg, KS 66762  
 800-856-4445

Basepoint Business Centre: Rivermead Drive, Westlea, Swindon SN5 7EX Teléfono: 0800-118-2476  
 J.P. Coenstraat 7, The Bridge, The Hague, 2595 WP, Netherlands. Teléfono: 08005678990

# PÉRGOLA BEAUMONT 14X12

## MODELO N.º 2101555



**ADVERTENCIA**

**Cáncer y daño reproductivo.**  
[www.P65Warnings.ca.gov](http://www.P65Warnings.ca.gov)



GABINETE ELÉCTRICO INCLUIDO  
 SOLO DISPONIBLE EN NORTEAMÉRICA

Visite [www.backyarddiscovery.com](http://www.backyarddiscovery.com)

For the most up to date assembly manual, to register your product, or to order replacement parts  
 Para obtener instrucciones en español, visite [www.backyarddiscovery.com](http://www.backyarddiscovery.com)



**PASO A PASO FÁCIL**  
 INSTRUCCIONES INTERACTIVAS EN 3D  
 DESCARGUE LA APLICACIÓN GRATUITA



**¡SERVICIOS DE INSTALACIÓN DISPONIBLES!\***

Consulte el interior para obtener más detalles

SOLO DISPONIBLE EN LOS ESTADOS UNIDOS

# DIMENSIONES BÁSICAS DE INSTALACIÓN Y NOTAS DE MONTAJE

Es de vital importancia que comience con la colocación y nivelación de los cimientos, la losa de hormigón o la plataforma para fijar su estructura.

- Preste mucha atención a los elementos necesarios para cada paso. Asegúrese de estar utilizando las piezas correctas para cada paso.

Utilizar las piezas incorrectas puede provocar un montaje ineficiente.

- Recuerde verificar los servicios subterráneos y los cables eléctricos aéreos.

**Se proporcionan soportes de postes con su estructura, lo que le permite instalar permanentemente su estructura en una superficie de madera u hormigón nueva o preexistente. Consulte las Instrucciones de anclaje para obtener más detalles y recomendaciones.**

- Se incluyen las piezas necesarias para unir los soportes de poste a la estructura.
- Se incluyen las piezas necesarias para montar la estructura permanentemente en una superficie de hormigón.
- Las piezas necesarias para montar la estructura permanentemente en una plataforma de madera NO están incluidas y deberán comprarse por separado. Debe asegurarse de que haya un amplio soporte estructural debajo de la plataforma antes de realizar la fijación permanente.

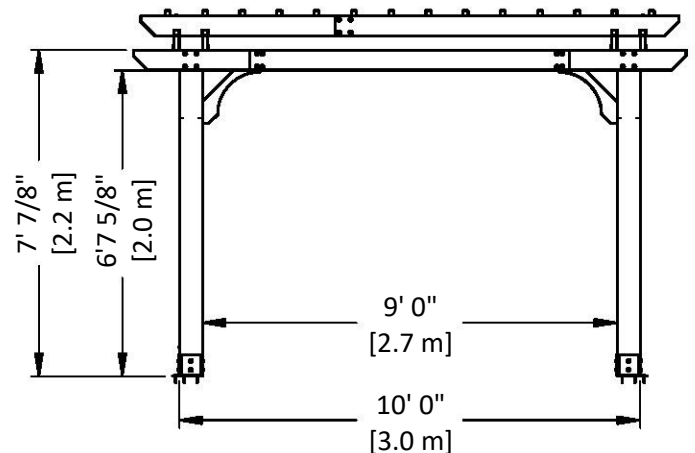
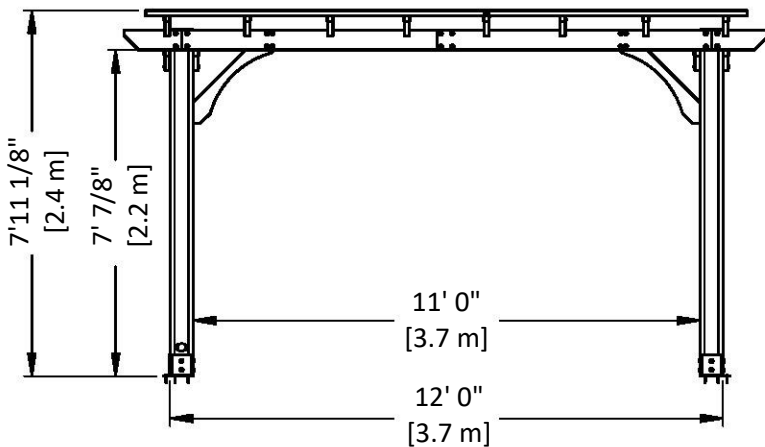
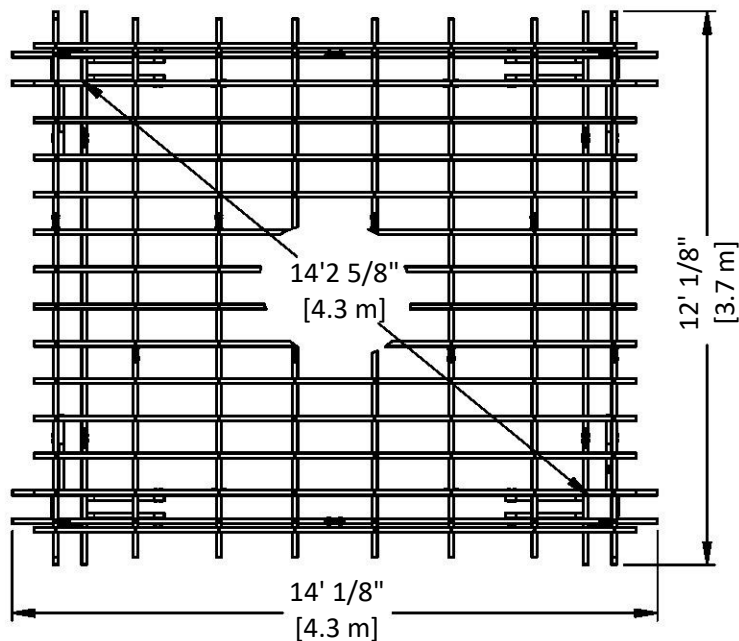

# MANUAL DEL PROPIETARIO - DISEÑO DE ANCLAJE

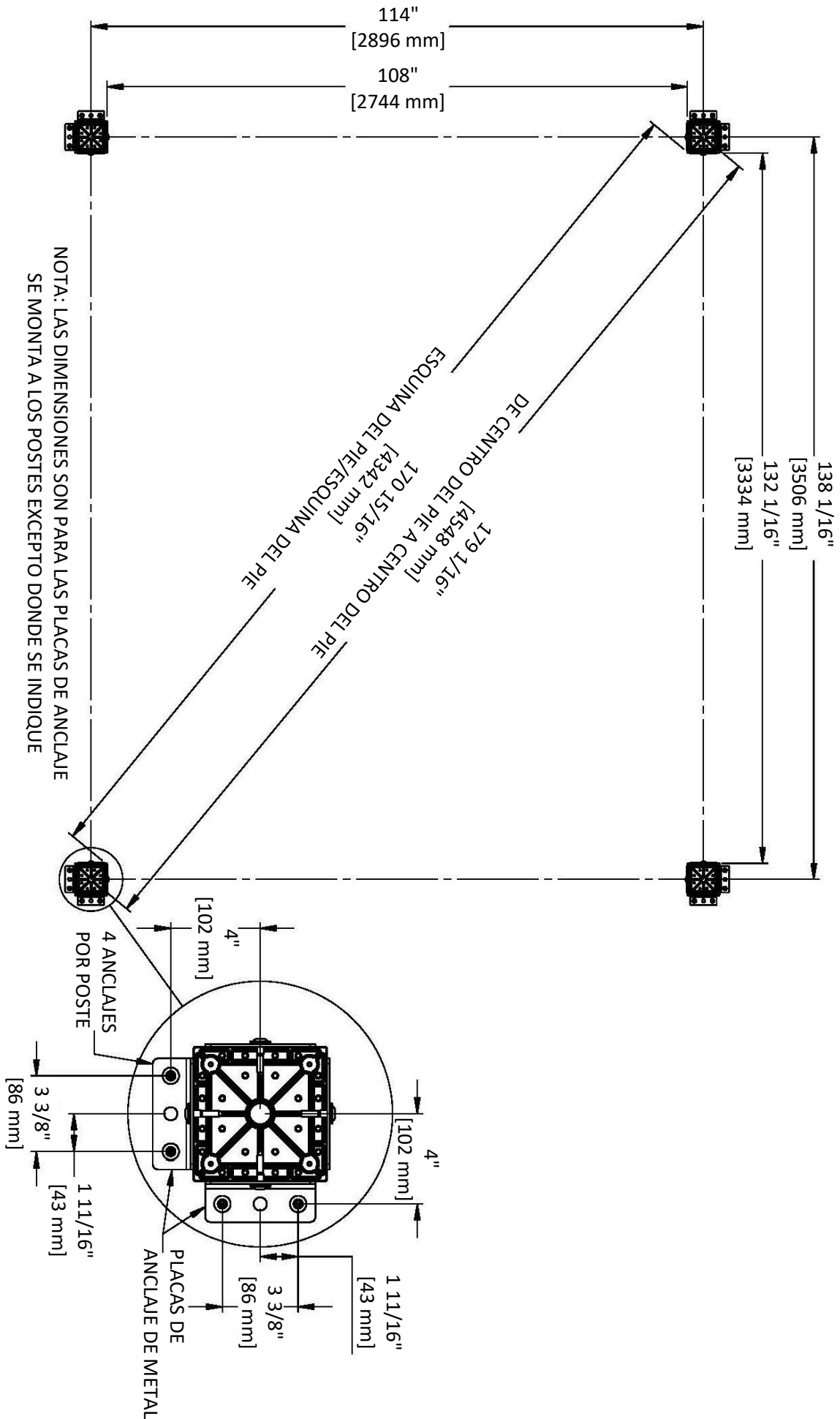

# MANUAL DEL PROPIETARIO - IDENTIFICACIÓN DE PIEZAS

## Componentes de madera (no a escala)

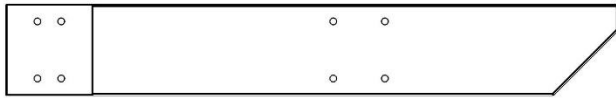

**D01** | EXTREMO DE LA VIGUETA - W4L15500  
(4) | 1 3/8"x5 1/4"x35 1/2" (36x134x902)

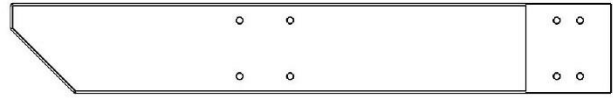

**D02** | EXTREMO DE LA VIGUETA - W4L15501  
(4) | 1 3/8"x5 1/4"x35 1/2" (36x134x902)



**D03** | EXTREMO DE LA VIGUETA - W4L15502  
(2) | 1 3/8"x5 1/4"x15" (36x134x382)



**D04** | EXTREMO DE LA VIGUETA - W4L15503  
(2) | 1 3/8"x5 1/4"x15" (36x134x382)

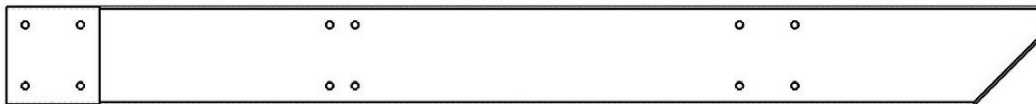

**D05** | EXTREMO DE LA VIGUETA - W4L15504  
(2) | 1 3/8"x5 1/4"x56 3/8" (36x134x1431)

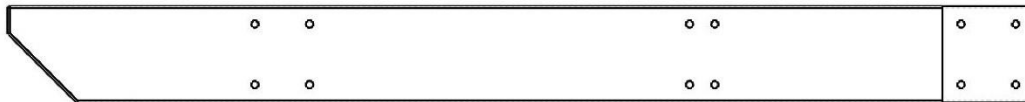

**D06** | EXTREMO DE LA VIGUETA - W4L15505  
(2) | 1 3/8"x5 1/4"x56 3/8" (36x134x1431)



**D07** | VIGUETA - W4L15506  
(4) | 1 3/8"x5 1/4"x83 1/8" (36x134x2112)



**D08** | VIGUETA - W4L15518  
(2) | 1 3/8"x5 1/4"x65 1/2" (36x134x1664)



**D09** | VIGUETA - W4L15519  
(2) | 1 3/8"x5 1/4"x74 1/2" (36x134x1893)



**D10** | VIGUETA - W4L15520  
(2) | 1 3/8"x5 1/4"x74 1/2" (36x134x1893)

# MANUAL DEL PROPIETARIO - IDENTIFICACIÓN DE PIEZAS

## Componentes de Madera (no están a escala)

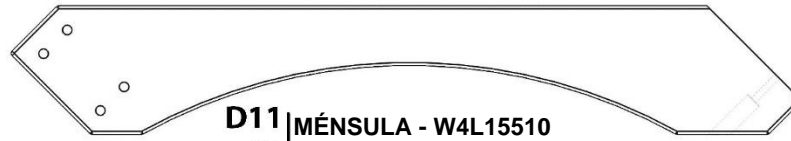

**D11** | MÉNSULA - W4L15510  
(8) | 1 3/8"x5 1/4"x32 1/2" (36x134x826)

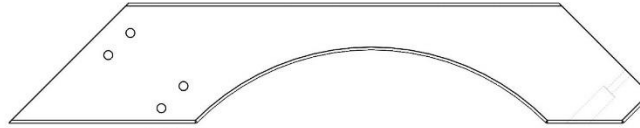

**D12** | MÉNSULA - W4L15513  
(3) | 1 3/8"x5 1/4"x28 1/4" (36x134x719)

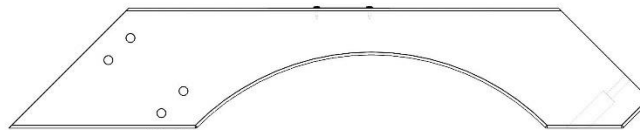

**D13** | MÉNSULA - W2A03243  
(1) | 1 3/8"x5 1/4"x28 1/4" (36x134x719)



**P10** | EXTREMO DE LA CORREA - W4L15521  
(14) | 1 3/8"x1 3/8"x68 3/4" (36x36x1746)

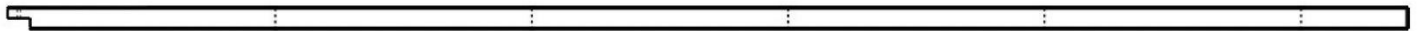

**P11** | EXTREMO DE LA CORREA - W4L15522  
(14) | 1 3/8"x1 3/8"x89 1/2" (36x36x2274)



**D14** | VIGUETA RANURADA - W4L15515  
(8) | 1 3/8"x5 1/4"x55 3/4" (36x134x1416)



**D15** | VIGUETA RANURADA - W4L15517  
(8) | 1 3/8"x5 1/4"x89 1/2" (36x134x2274)

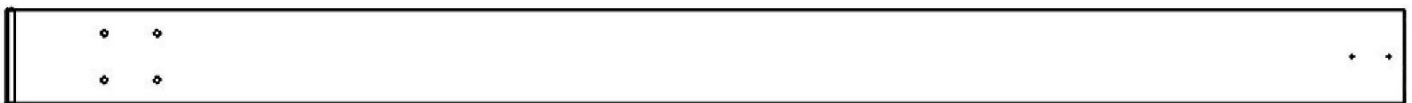

**P01** | POSTE - W2A03241  
(2) | 6"x6"x89 1/2" (152x152x2274)



**P02** | POSTE - W2A03242  
(2) | 6"x6"x89 1/2" (152x152x2274)

# MANUAL DEL PROPIETARIO - IDENTIFICACIÓN DE PIEZAS

## Componentes metálicos

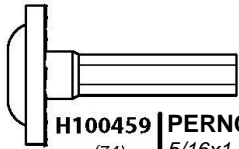

H100459 | PERNO BL NG  
(74) | 5/16x1 1/4

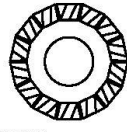

H100198 | ARANDELA DE FIJACIÓN  
(173) | EXT NG 8x19

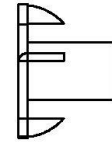

H100379 | TUERCA EN T NG  
(155) | 5/16x5/8

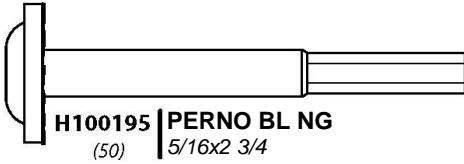

H100195 | PERNO BL NG  
(50) | 5/16x2 3/4

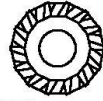

H100405 | ARANDELA DE FIJACIÓN  
EXT NG 6x15



H100398 | TUERCA EN T NG  
(15) | 1/4x7/16

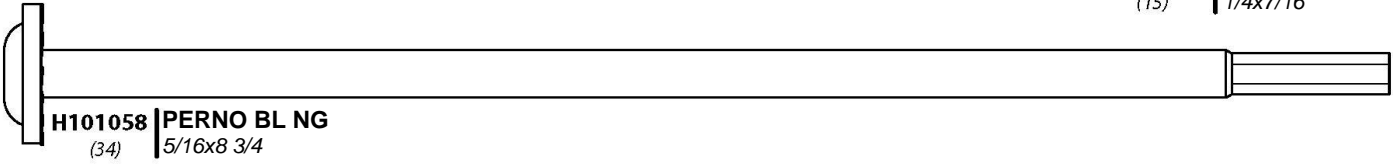

H101058 | PERNO BL NG  
(34) | 5/16x8 3/4

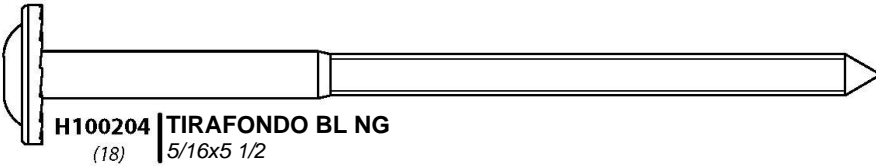

H100204 | TIRAFONDO BL NG  
(18) | 5/16x5 1/2



H100201 | TORNILLO PFH NG  
(102) | 8x2 1/2

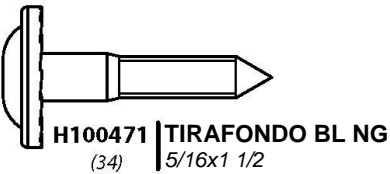

H100471 | TIRAFONDO BL NG  
(34) | 5/16x1 1/2

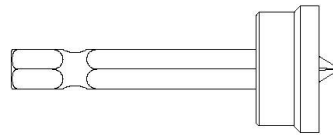

H100764 | TORNILLO AUTORREGULADOR  
(1)



H100200 | TORNILLO PFH NG  
(17) | 8x1 1/2

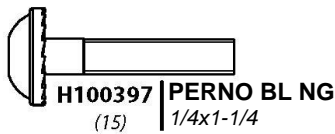

H100397 | PERNO BL NG  
(15) | 1/4x1-1/4

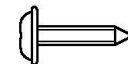

H100202 | TORNILLO PWH NG  
(2) | 8x5/8



H100792 | TIRAFONDO BL NG  
(13) | 1/4x3

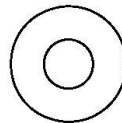

H100630 | ARANDELA PLANA NG  
(18) | 8x19

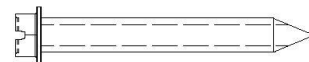

H100120 | TORNILLO DE ANCLAJE DE HORMIGÓN  
(18) | 1/4x2

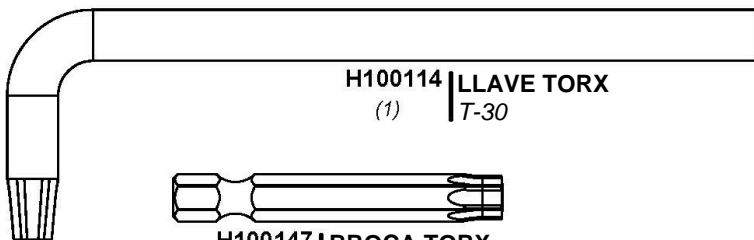

H100114 | LLAVE TORX  
(1) | T-30

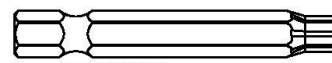

A100042 | BROCA TORX  
(1) | T-40

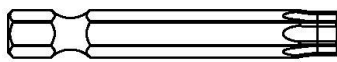

H100147 | BROCA TORX  
(1) | T-30

A100041 | LLAVE TORX  
(1) | T-40

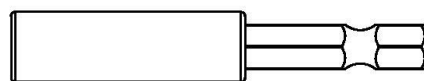
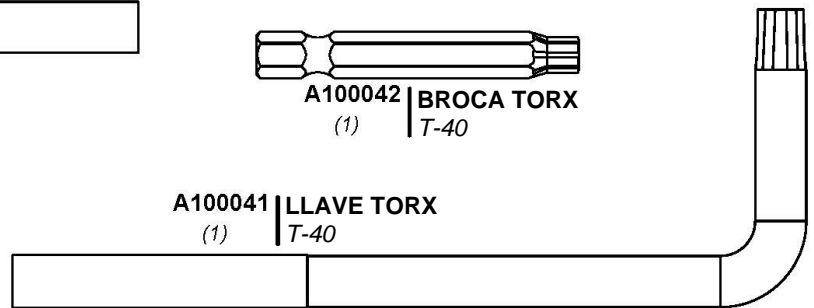

H101100 | DESTORNILLADOR DE PUNTA MAGNÉTICA  
(1)

# MANUAL DEL PROPIETARIO - IDENTIFICACIÓN DE PIEZAS

## Componentes Accesorios (No a escala)



**A100241**  
*(1)* | ETIQUETA DE IDENTIFICACIÓN DE BACKYARD (PEQUEÑA) SIN EDADES

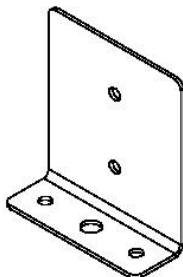

**A4M00977**  
*(x8)* | PLACA DE ANCLAJE DE POSTE

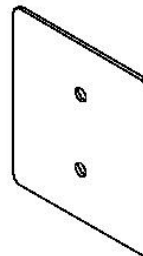

**A4M00978**  
*(x8)* | PLACA DE POSTE

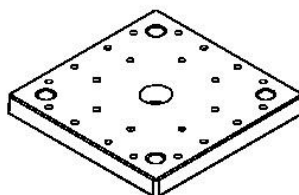

**A6P00308**  
*(x4)* | PIE DE POSTE 6 x 6

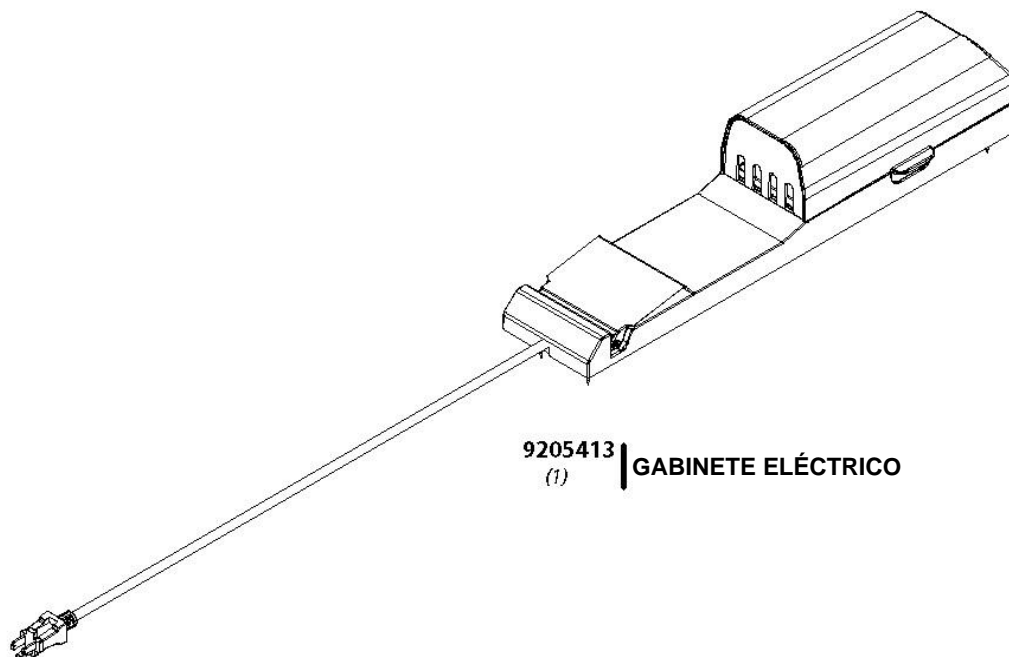

**9205413**  
*(1)* | GABINETE ELÉCTRICO

# ANTES DEL MONTAJE - PASO 1 - CLASIFICACIÓN DE PIEZAS

Para facilitar el montaje, es fundamental que se tome el tiempo de clasificar y organizar las piezas de madera y las piezas metálicas.

## PIEZAS DE MADERA:

- Organice las piezas de madera por el número alfanumérico de tres dígitos impreso en cada tabla (ej. P01).
- Si hay varias tablas con el mismo número impreso, separe esas piezas juntas.
- Los números impresos están en la superficie plana o en el extremo de las tablas.
- Deje suficiente espacio: las piezas de madera pueden ocupar mucho espacio.

**NOTA: LAS CAJAS NO ESTÁN ORGANIZADAS SEGÚN EL NÚMERO DE TABLA.**



## PIEZAS METÁLICAS:

- Le recomendamos que separe las piezas metálicas en una mesa separada.
- Las bolsas de piezas metálicas llevan impreso un código de pieza alfanumérico de siete caracteres.
- Puede organizar las piezas metálicas por número de pieza o agruparlas por tipo de pieza (pernos, tuercas, etc.).
- Durante el montaje, solo necesita consultar los últimos cuatro caracteres del número.

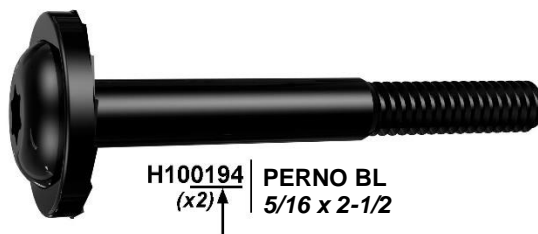



# ANTES DEL MONTAJE - PASO 2 - HERRAMIENTAS REQUERIDAS



Taladro inalámbrico  
o eléctrico

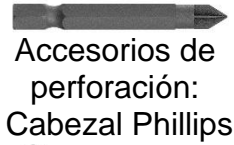

Accesorios de  
perforación:  
Cabezal Phillips



Brocas de 1/8", 3/16",  
3/8" y 7/16"



Destornillador Phillips

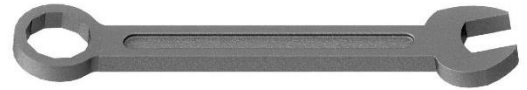

Llaves de extremos abiertos  
de 1/2" y 9/16"



Trinquete con adaptadores de 3/8",  
llave de tubo STD de 1/2" y 7/16" y  
llave de tubo de cuello largo de 1/2"  
y 7/16"



Martillo de orejas



Mazo de goma  
- opcional

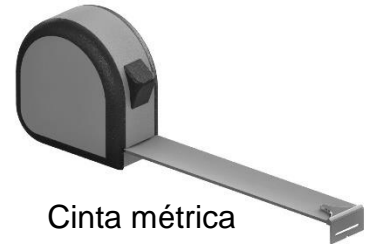

Cinta métrica

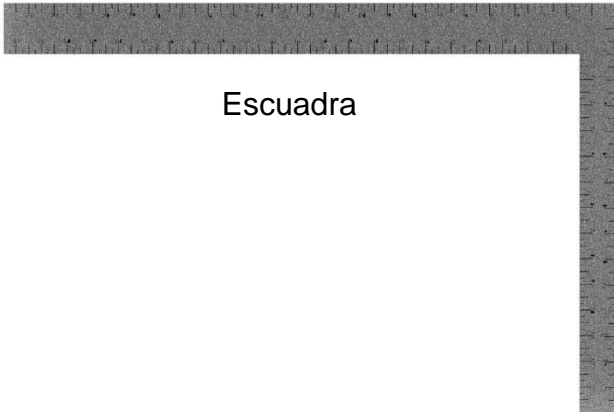

Escuadra

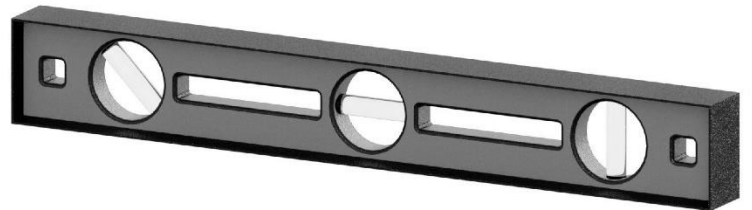

Nivel 24"

# ANTES DEL MONTAJE - PASO 3 - ELIJA EL MÉTODO DE MONTAJE

Hay varios tipos de instrucciones de montaje disponibles.

1. Manual de montaje impreso incluido con el juego.
2. APLICACIÓN BILT: instrucciones interactivas en 3D
3. Combinación del manual impreso y la APLICACIÓN BILT (Nota: Los números de paso pueden diferir entre los dos métodos)



**Escanee para obtener instrucciones sencillas en 3D**

Descargue la aplicación BILT antes de comenzar



# PASO 4 - MONTAJE DE LA PÉRGOLA



**P01 | POSTE - W2A03241**  
(2) | 6"x6"x89 1/2" (152x152x2274)

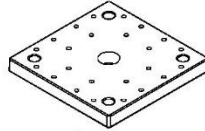

**A6P00308 | PIE DE POSTE 6 x 6**  
(x4)



**H100200 | TORNILLO PFH NG**  
(16) | 8x1 1/2

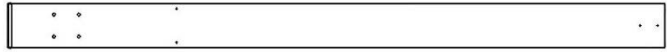

**P02 | POSTE - W2A03242**  
(2) | 6"x6"x89 1/2" (152x152x2274)

## COMPLETE ESTE PASO DOS VECES.

PARA FACILIDAD DE MONTAJE, RECOMENDAMOS  
USO DE CABALLOS DE SIERRA PARA LOS PASOS 4 AL 10.

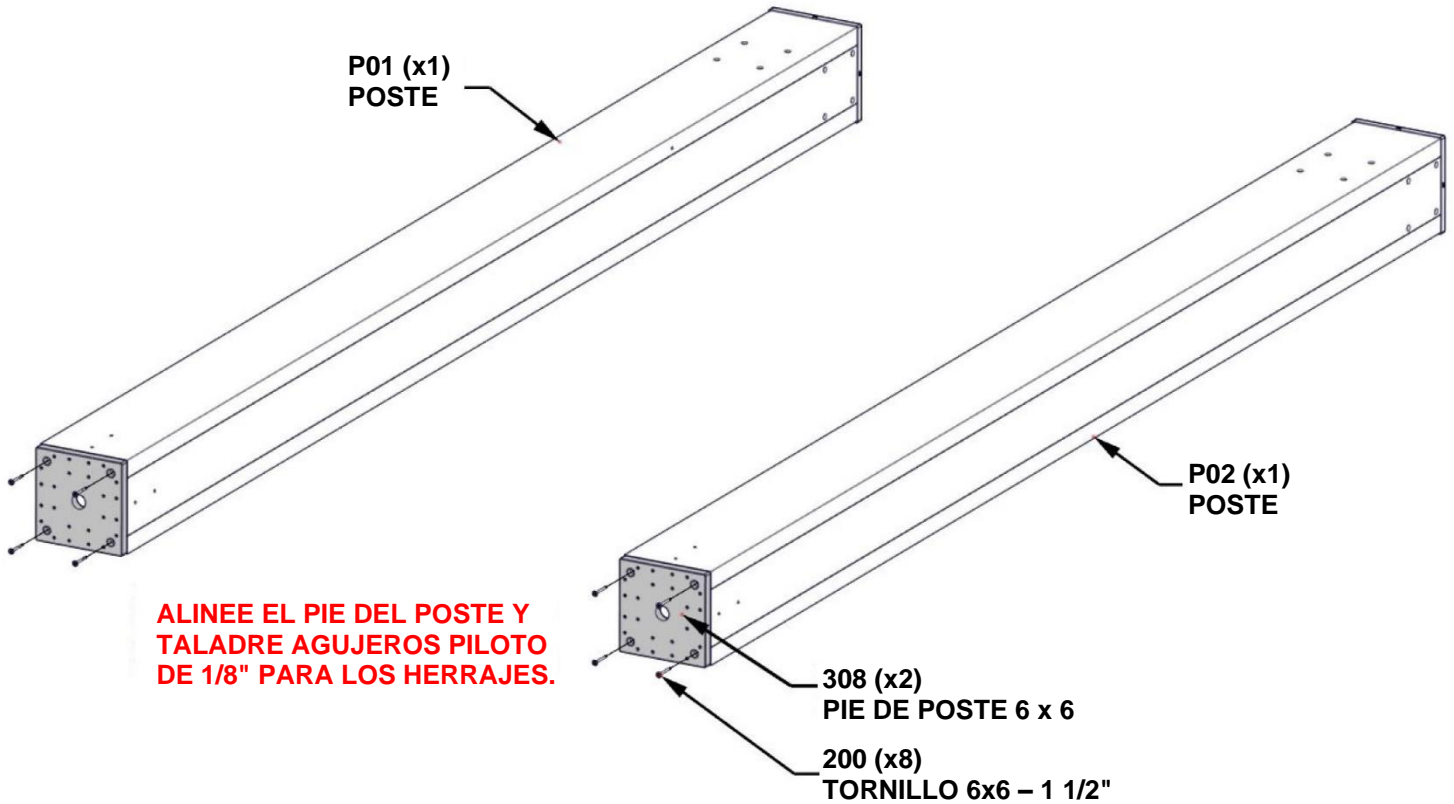

# PASO 5 - MONTAJE DE LA PÉRGOLA



**D01** EXTREMO DE LA VIGUETA - W4L15500

(1) 1 3/8"x5 1/4"x35 1/2" (36x134x902)



**D02** EXTREMO DE LA VIGUETA - W4L15501

(1) 1 3/8"x5 1/4"x35 1/2" (36x134x902)

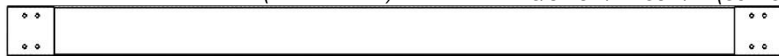

**D07** VIGUETA - W4L15506

(1) 1 3/8"x5 1/4"x83 1/8" (36x134x2112)



**D12** MÉNSULA - W4L15513

(1) 1 3/8"x5 1/4"x28 1/4" (36x134x719)



**D13** MÉNSULA - W2A03243

(1) 1 3/8"x5 1/4"x28 1/4" (36x134x719)

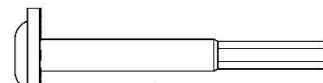

**H100195** PERNO BL NG

(8) 5/16x2 3/4

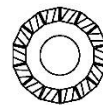

**H100198** ARANDELA DE FIJACIÓN EXT NG 8x19

(8)



**H100379** TUERCA EN T NG

(8) 5/16x5/8

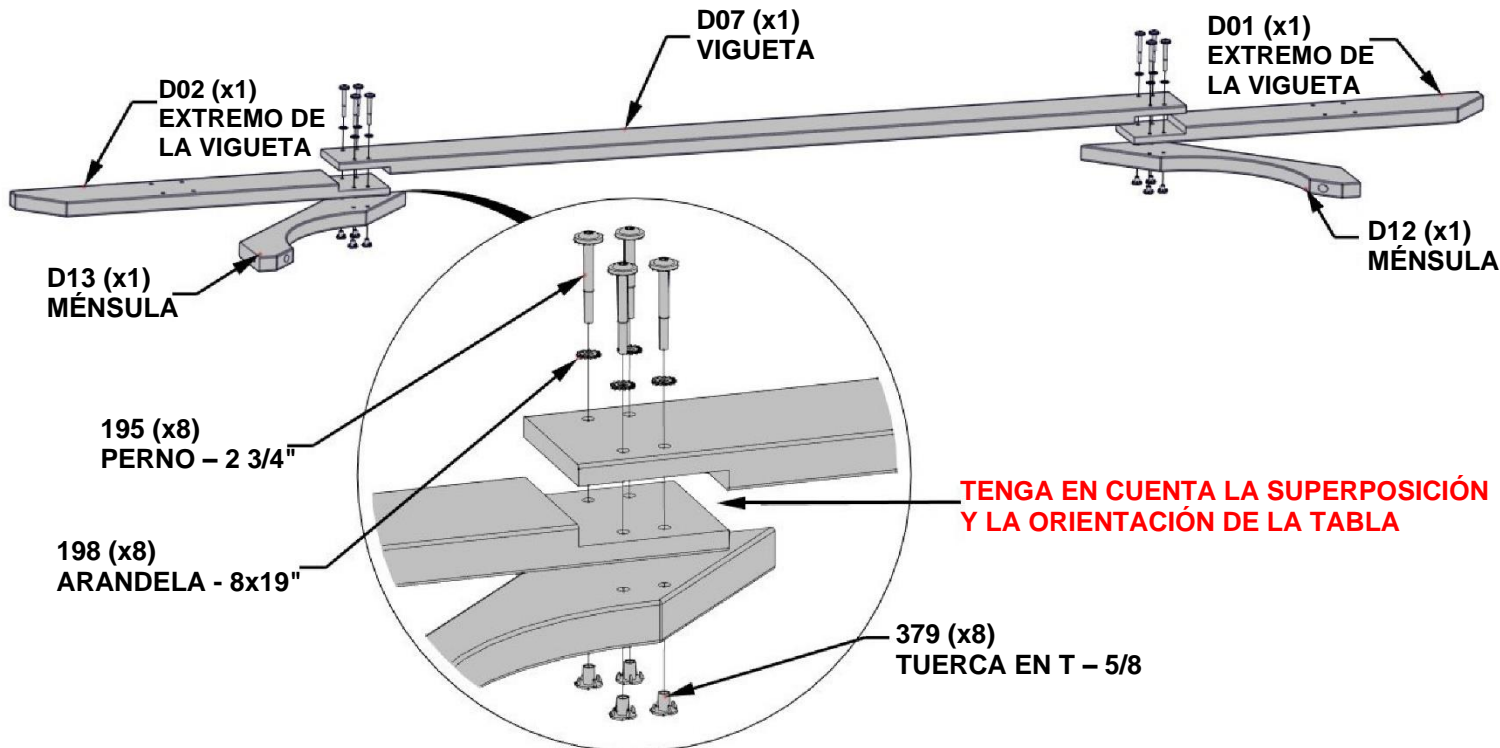

# PASO 6 - MONTAJE DE LA PÉRGOLA



**D01** | EXTREMO DE LA VIGUETA -  
**W4L15500**  
 (1) | 1 3/8"x5 1/4"x35 1/2" (36x134x902)

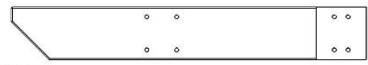

**D02** | EXTREMO DE LA VIGUETA -  
**W4L15501**  
 (1) | 1 3/8"x5 1/4"x35 1/2" (36x134x902)

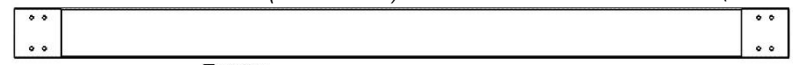

**D07** | VIGUETA - **W4L15506**  
 (1) | 1 3/8"x5 1/4"x83 1/8" (36x134x2112)



**D12** | MÉNSULA - **W4L15513**  
 (2) | 1 3/8"x5 1/4"x28 1/4" (36x134x719)

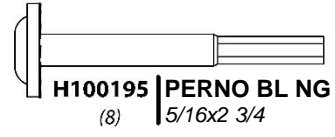

**H100195** | PERNO BL NG  
 (8) | 5/16x2 3/4



**H100198** | ARANDELA DE  
 (8) | FIJACIÓN  
 EXT NG 8x19

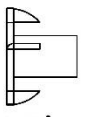

**H100379** | TUERCA EN  
 (8) | T NG  
 5/16x5/8

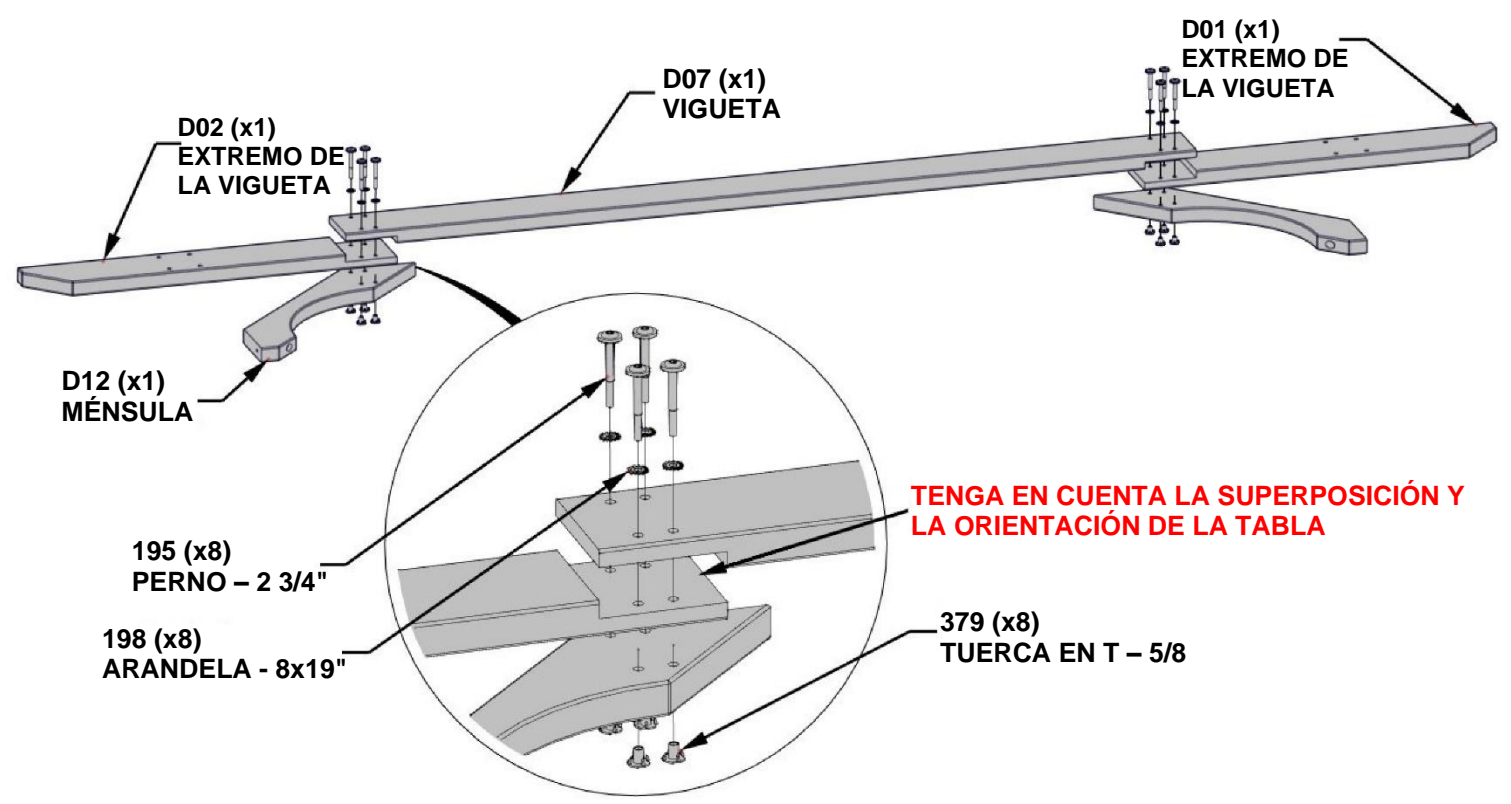

# PASO 7 - MONTAJE DE LA PÉRGOLA



**D01** EXTREMO DE LA VIGUETA -  
W4L15500

(2) 1 3/8"x5 1/4"x35 1/2" (36x134x902)

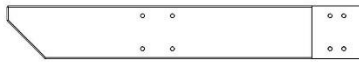

**D02** EXTREMO DE LA VIGUETA -  
W4L15501

(2) 1 3/8"x5 1/4"x35 1/2" (36x134x902)



**D07** VIGUETA - W4L15506

(2) 1 3/8"x5 1/4"x83 1/8" (36x134x2112)

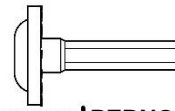

**H100459** PERNO BL NG  
(16) 5/16x2 3/4



**H100198** ARANDELA DE  
FIJACIÓN  
EXT NG 8x19  
(16)

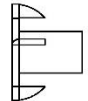

**H100379** TUERCA EN  
T NG  
(16) 5/16x5/8

**COMPLETE ESTE PASO DOS VECES.**

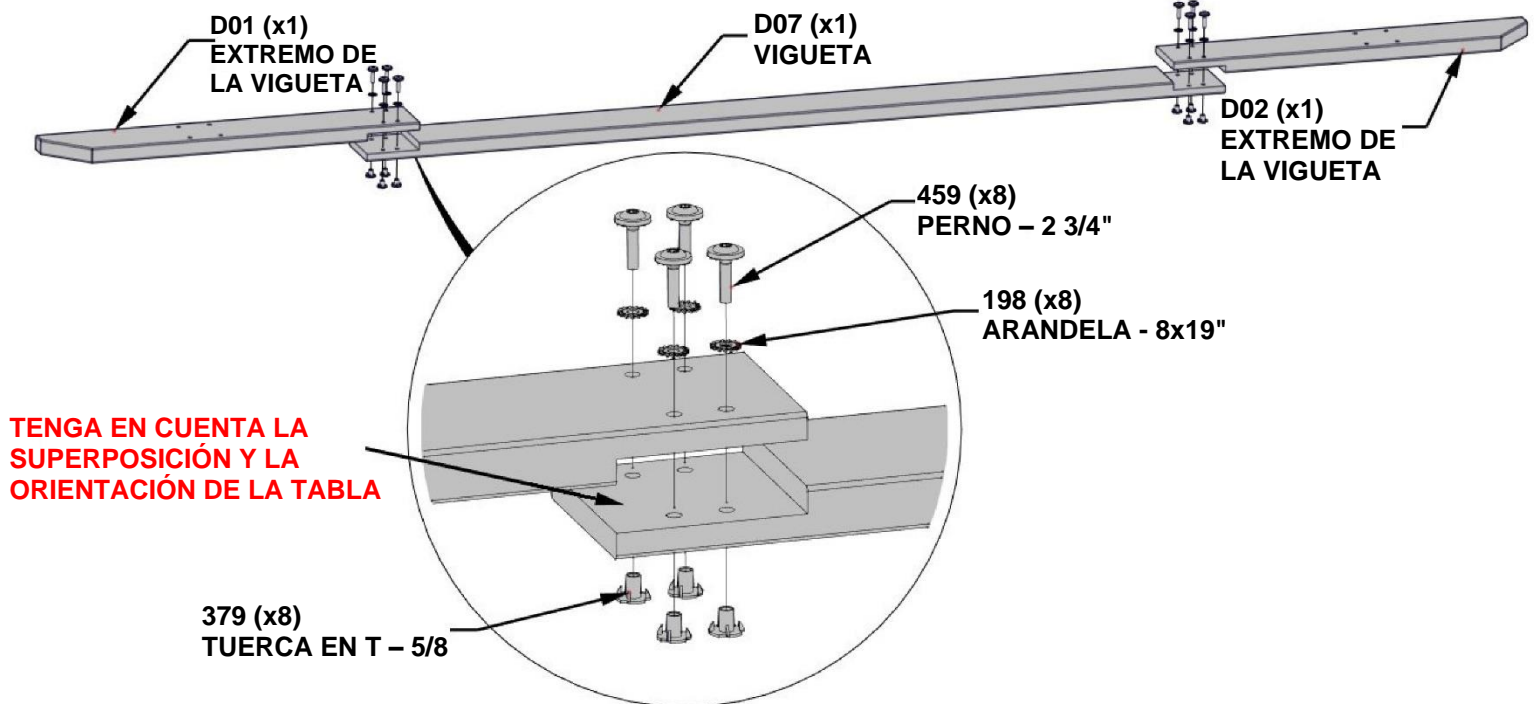

# PASO 8 - MONTAJE DE LA PÉRGOLA

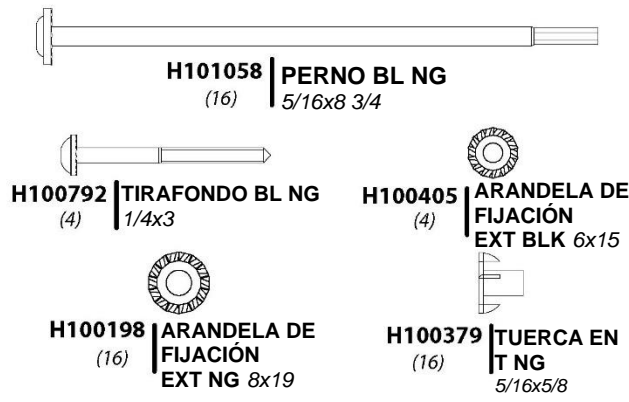
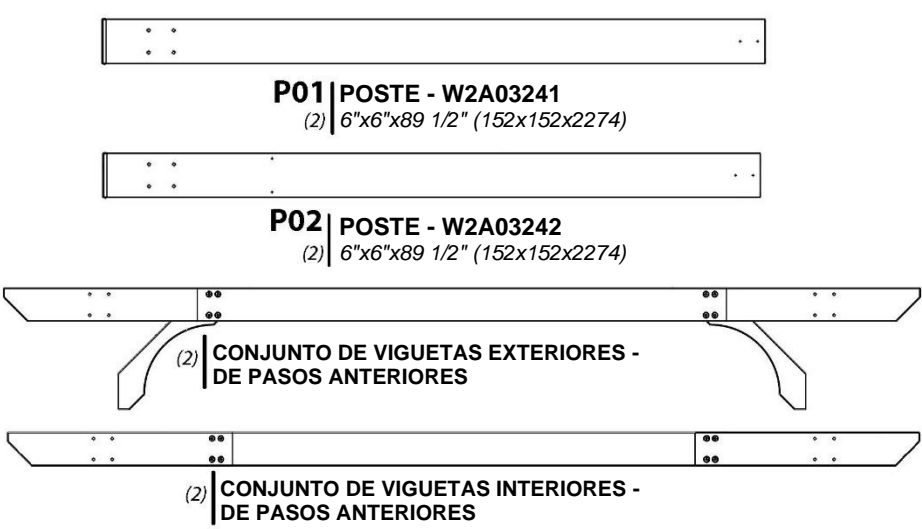

**COMPLETE ESTE PASO DOS VECES.**

**MONTE COMO SE MUESTRA UTILIZANDO LOS ORIFICIOS GUÍA PREVIAMENTE PERFORADOS EN LOS POSTES.**

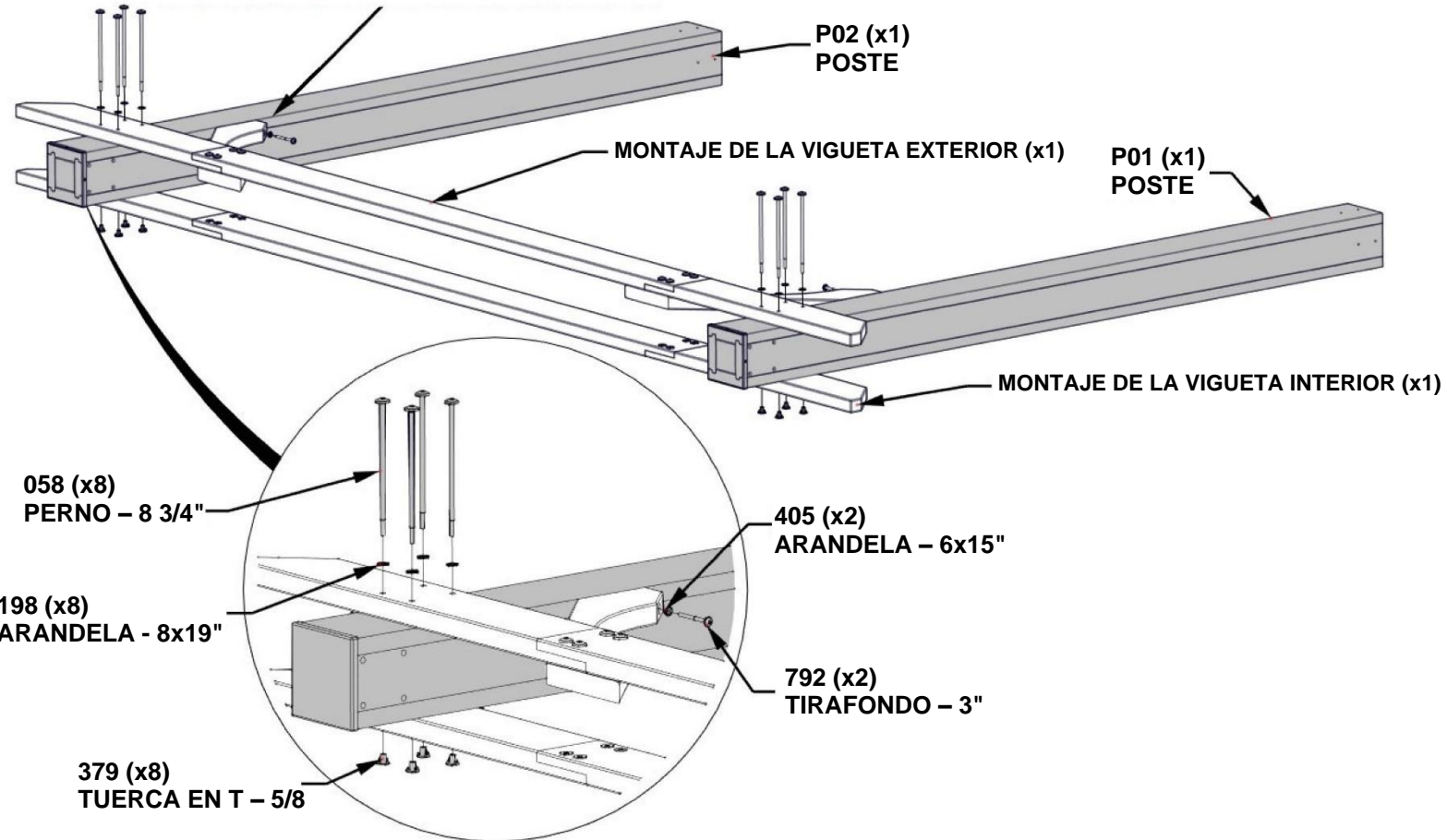

# PASO 9 - MONTAJE DE LA PÉRGOLA



**D09 | VIGUETA - W4L15519**  
(2) | 1 3/8"x5 1/4"x74 1/2" (36x134x1893)



**D10 | VIGUETA - W4L15520**  
(2) | 1 3/8"x5 1/4"x74 1/2" (36x134x1893)



**D11 | MÉNSULA - W4L15510**  
(4) | 1 3/8"x5 1/4"x32 1/2" (36x134x826)

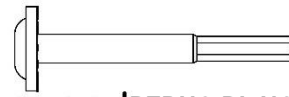

**H100195 | PERNO BL NG**  
(16) | 5/16x2 3/4

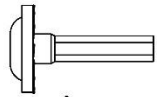

**H100459 | PERNO BL NG**  
(8) | 5/16x1 1/4



**H100198 | ARANDELA DE FIJACIÓN EXT NG**  
(24) | 8x19



**H100379 | TUERCA EN T NG**  
(24) | 5/16x5/8

**COMPLETE ESTE PASO DOS VECES.**

**ASEGÚRESE DE QUE LOS ORIFICIOS GUÍA MIREN HACIA ARRIBA Y DE QUE LAS VIGUETAS ESTÉN ORIENTADAS CORRECTAMENTE.**

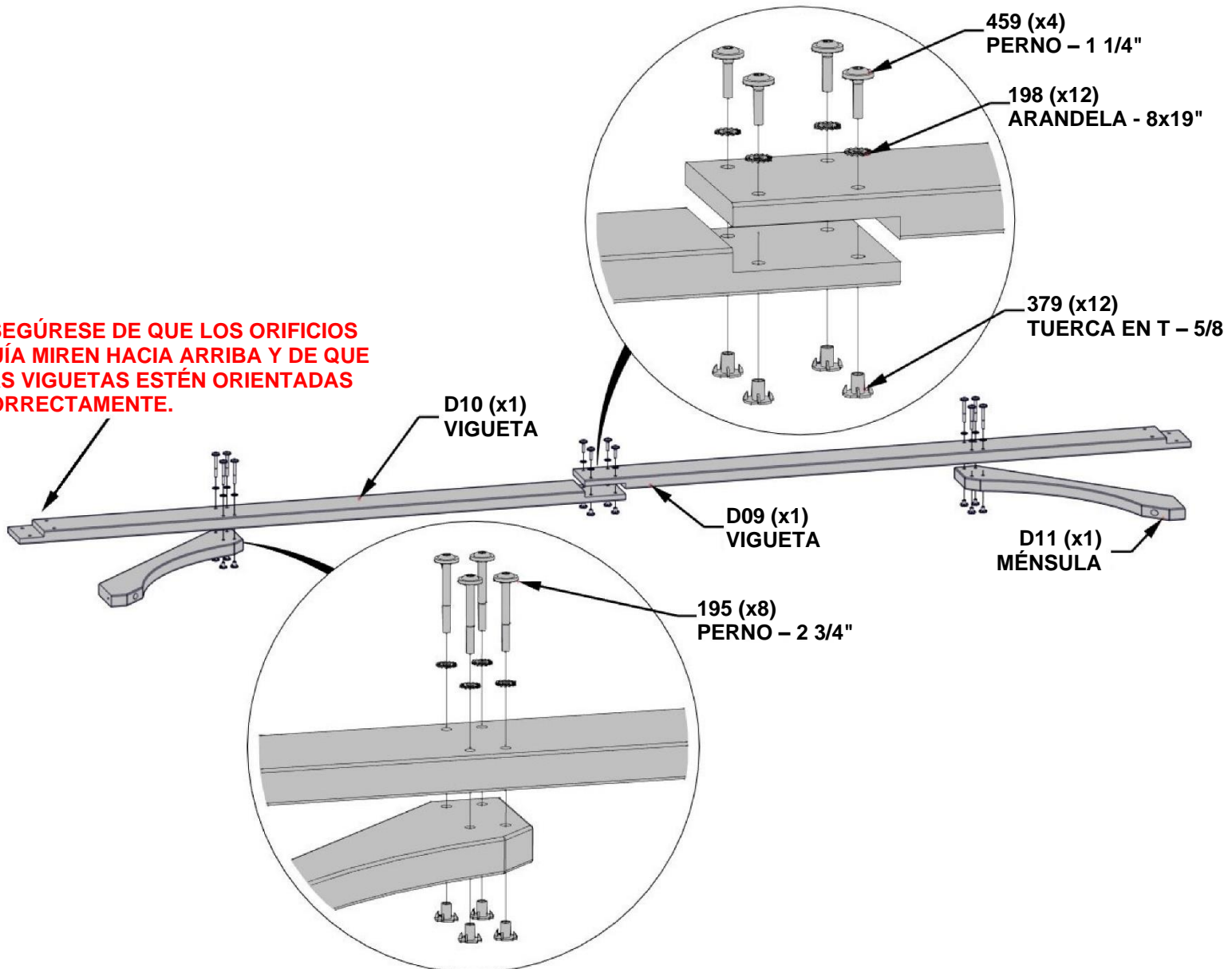



# PASO 10 - MONTAJE DE LA PÉRGOLA

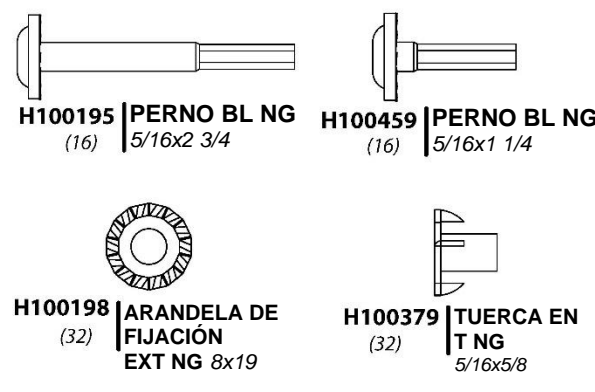
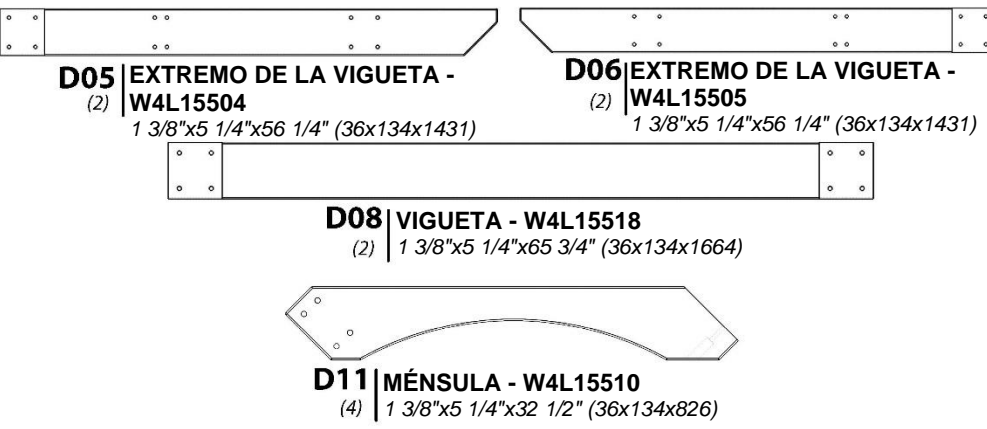

**COMPLETE ESTE PASO DOS VECES.**

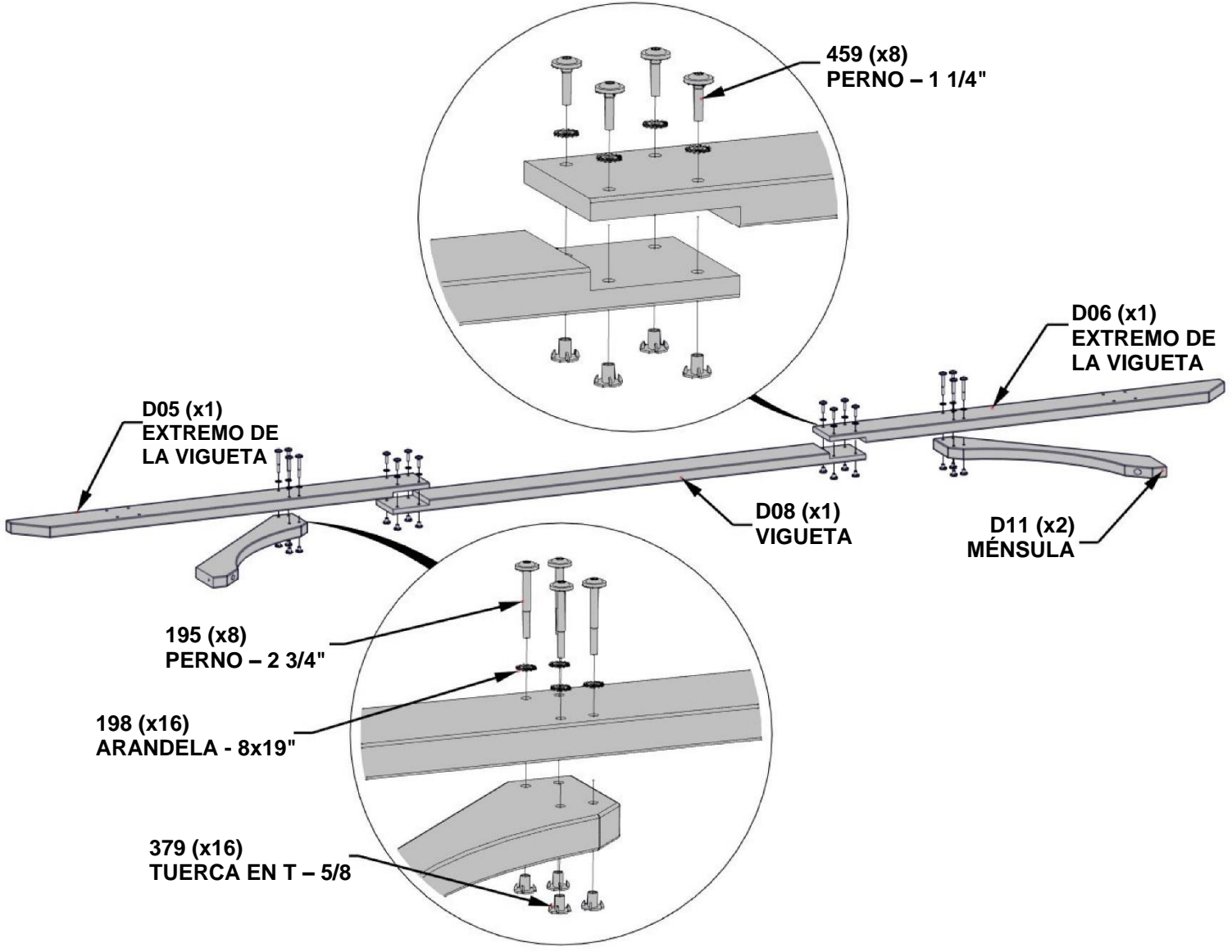

# PASO 11 - MONTAJE DE LA PÉRGOLA

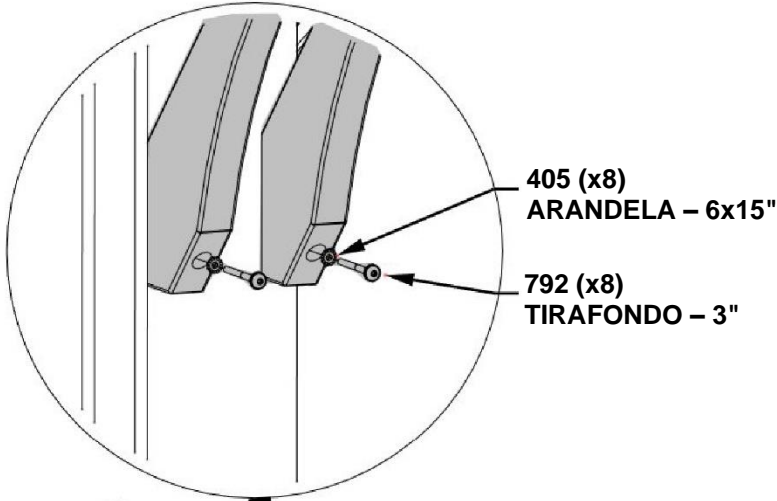
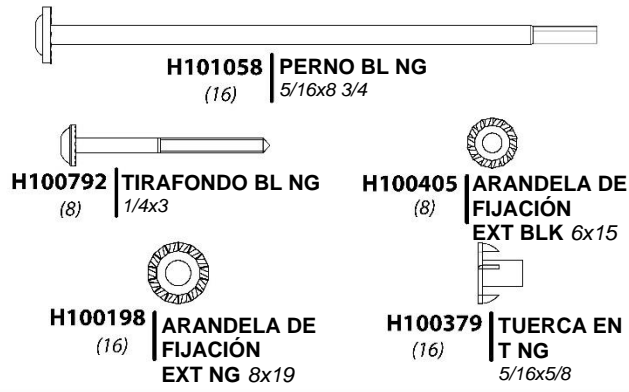
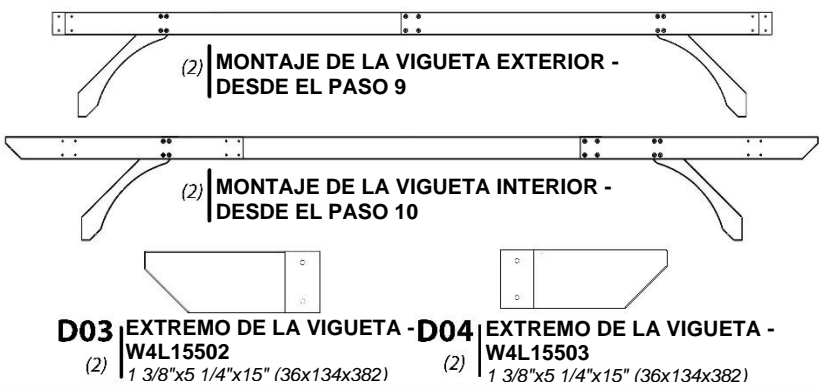

CON AMBOS MONTAJES DEL MONTANTE DE PIE, ATORNILLE EL MONTAJE DE LA VIGUETA INTERIOR Y EXTERIOR A UNO DE LOS LADOS. LUEGO ATORNILLE EL MONTAJE DE LA VIGUETA AL OTRO LADO.

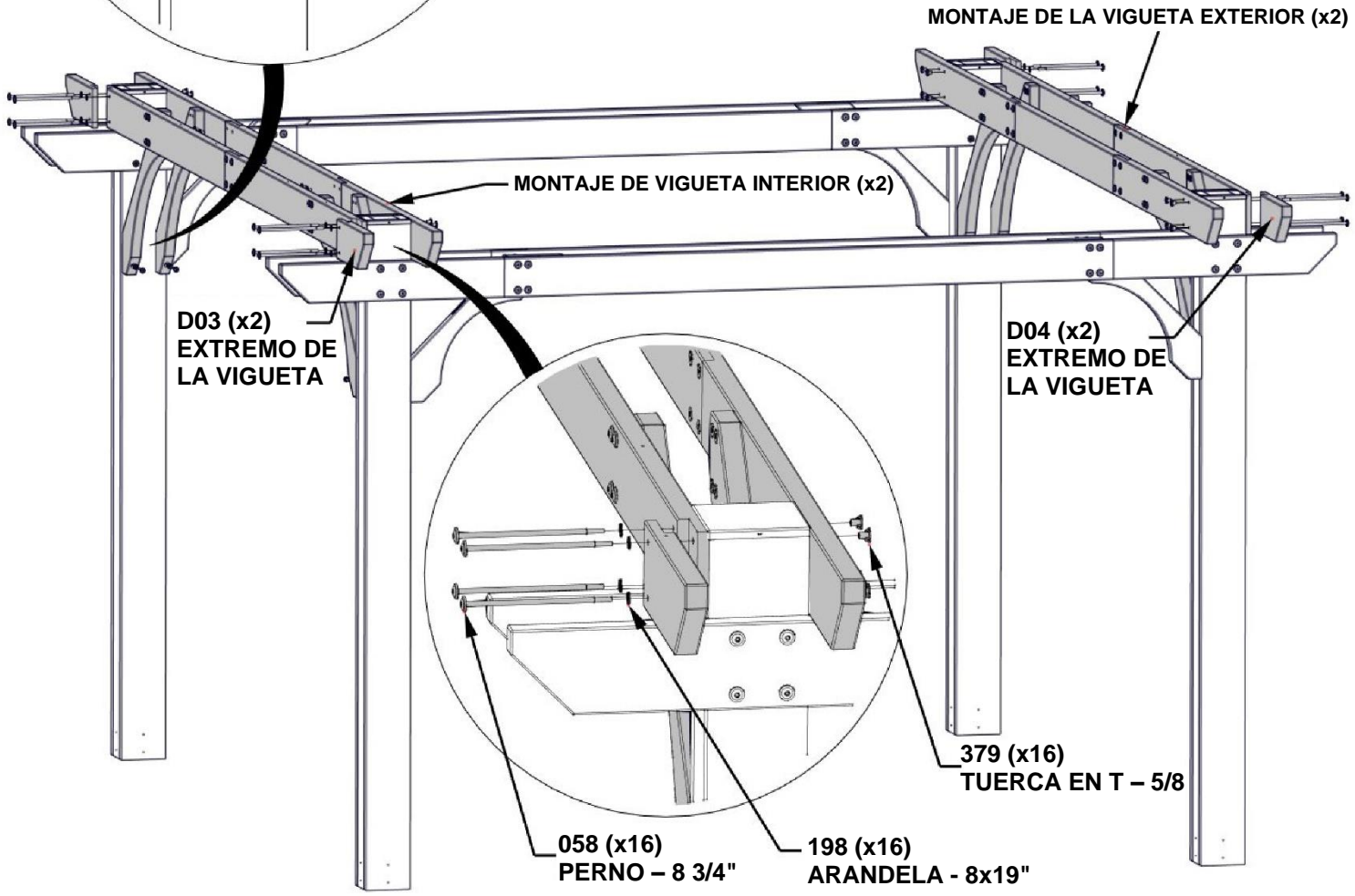

NIVELÉ TODOS LOS POSTES CON LAS VIGUETAS Y AJUSTE COMPLETAMENTE TODOS LOS PERNOS Y TORNILLOS.

**NOTA: UNA TERCERA PERSONA PUEDE AYUDARLO EN ESTE PASO.**

# PASO 12 - MONTAJE DE LA PÉRGOLA

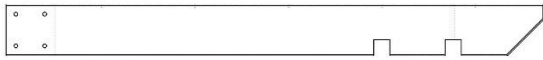

**D14** VIGUETA RANURADA - W4L15515  
(8) 1 3/8"x5 1/4"x55 3/4" (36x134x1416)

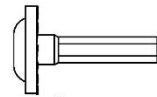

**H100459** PERNO BL NG  
(32) 5/16x1 1/4

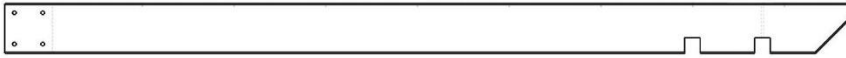

**D15** VIGUETA RANURADA - W4L15517  
(8) 1 3/8"x5 1/4"x89 1/2" (36x134x2274)



**H100198** ARANDELA DE FIJACIÓN EXT NG 8x19  
(32)



**H100379** TUERCA EN T NG 5/16x5/8  
(32)

**COMPLETE ESTE PASO OCHO VECES.**

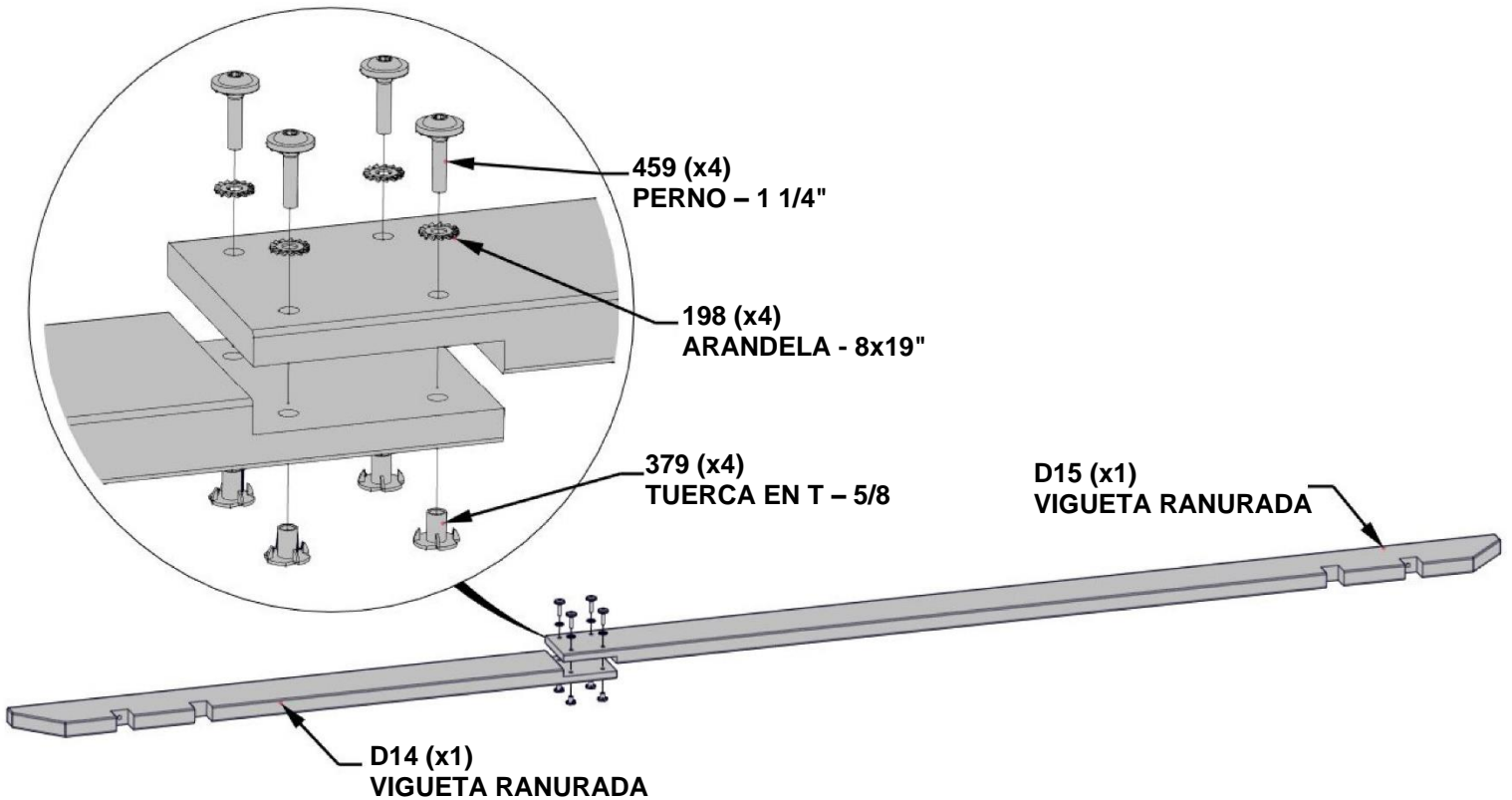

# PASO 13 - MONTAJE DE LA PÉRGOLA

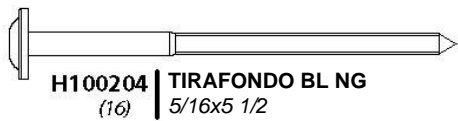

H100198 | ARANDELA DE FIJACIÓN  
(16) EXT NG 8x19

**FIJE EL MONTAJE DE LA VIGUETA RANURADA USANDO LOS ORIFICIOS GUÍA QUE ESTÁN EN EL MONTAJE DE LA VIGUETA EXTERIOR**

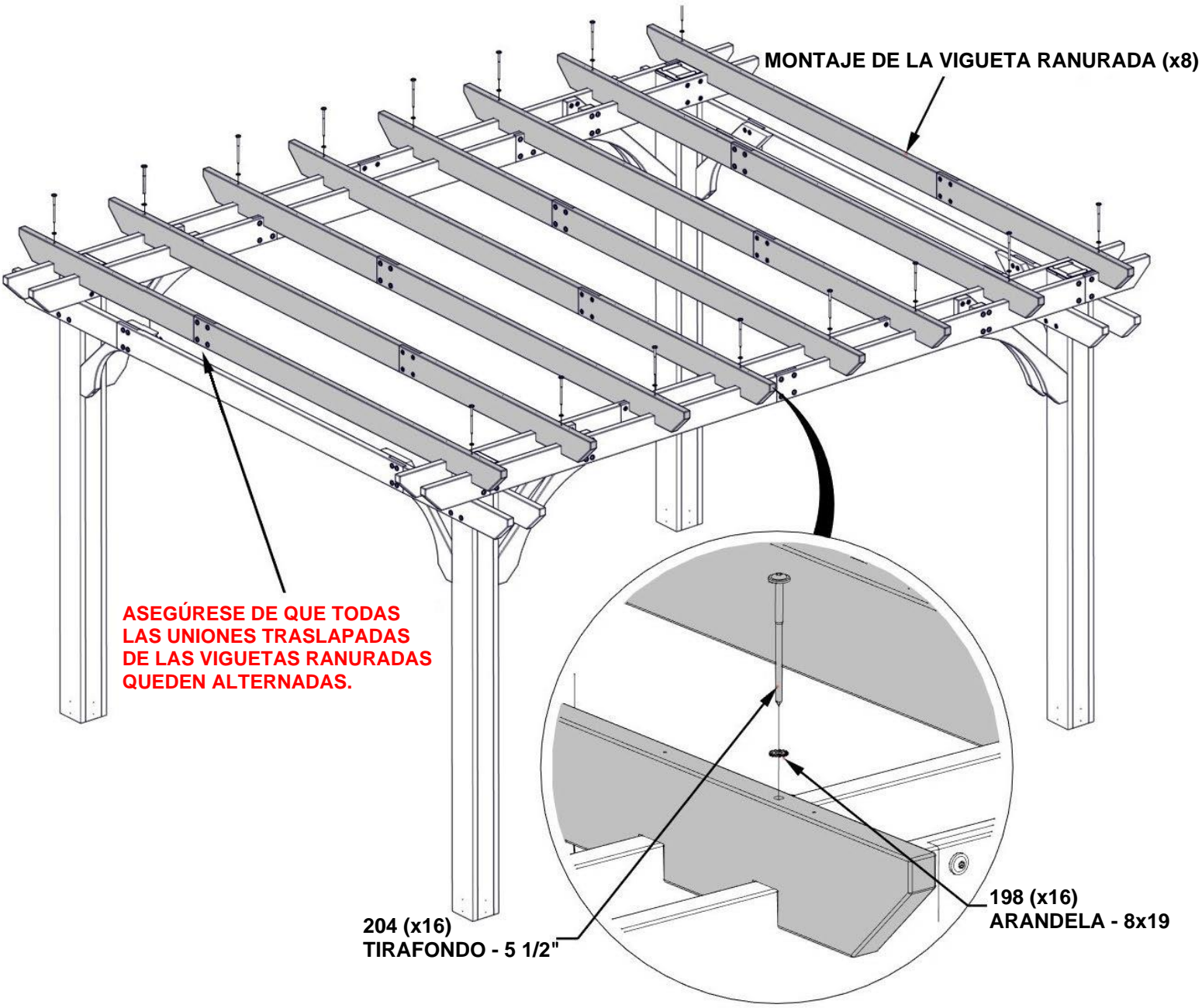

# PASO 14 - MONTAJE DE LA PÉRGOLA

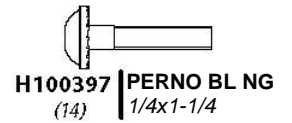
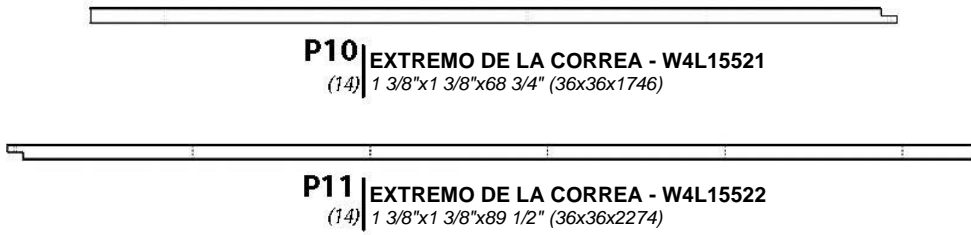

**COMPLETE ESTE PASO CATORCE VECES.**

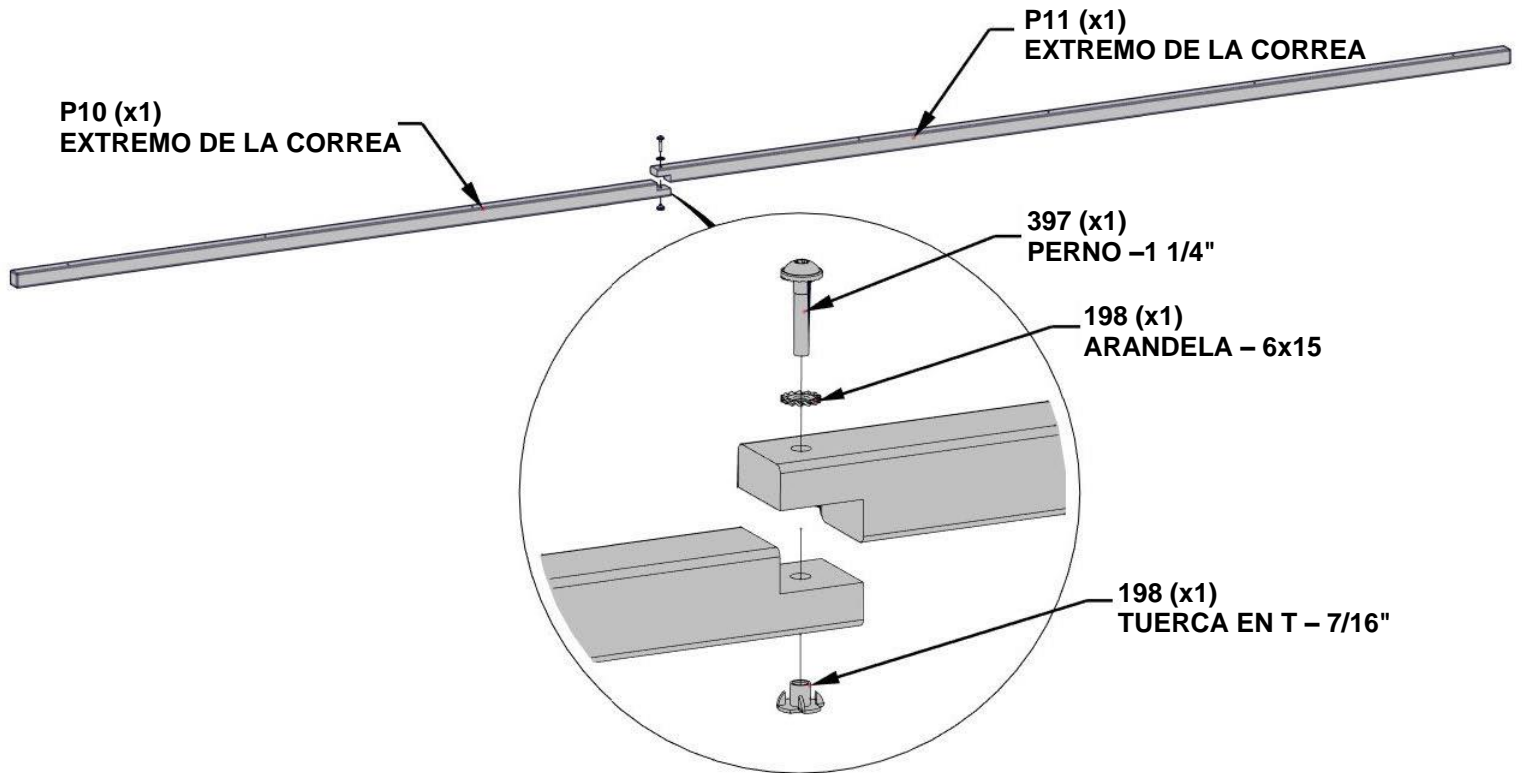

# PASO 15 - MONTAJE DE LA PÉRGOLA

(14) CONJUNTO DE LA CORREA - DE PASOS ANTERIORES

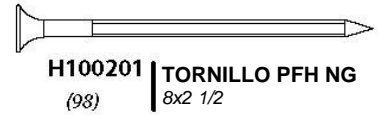

**AL LEVANTAR CADA MONTAJE DE CORREA, ASEGÚRESE DE QUE LAS UNIONES ESTÉN APOYADAS Y DE QUE LA CORREA SE MANTENGA NIVELADA.**

MONTAJE DE LA CORREA (x14)

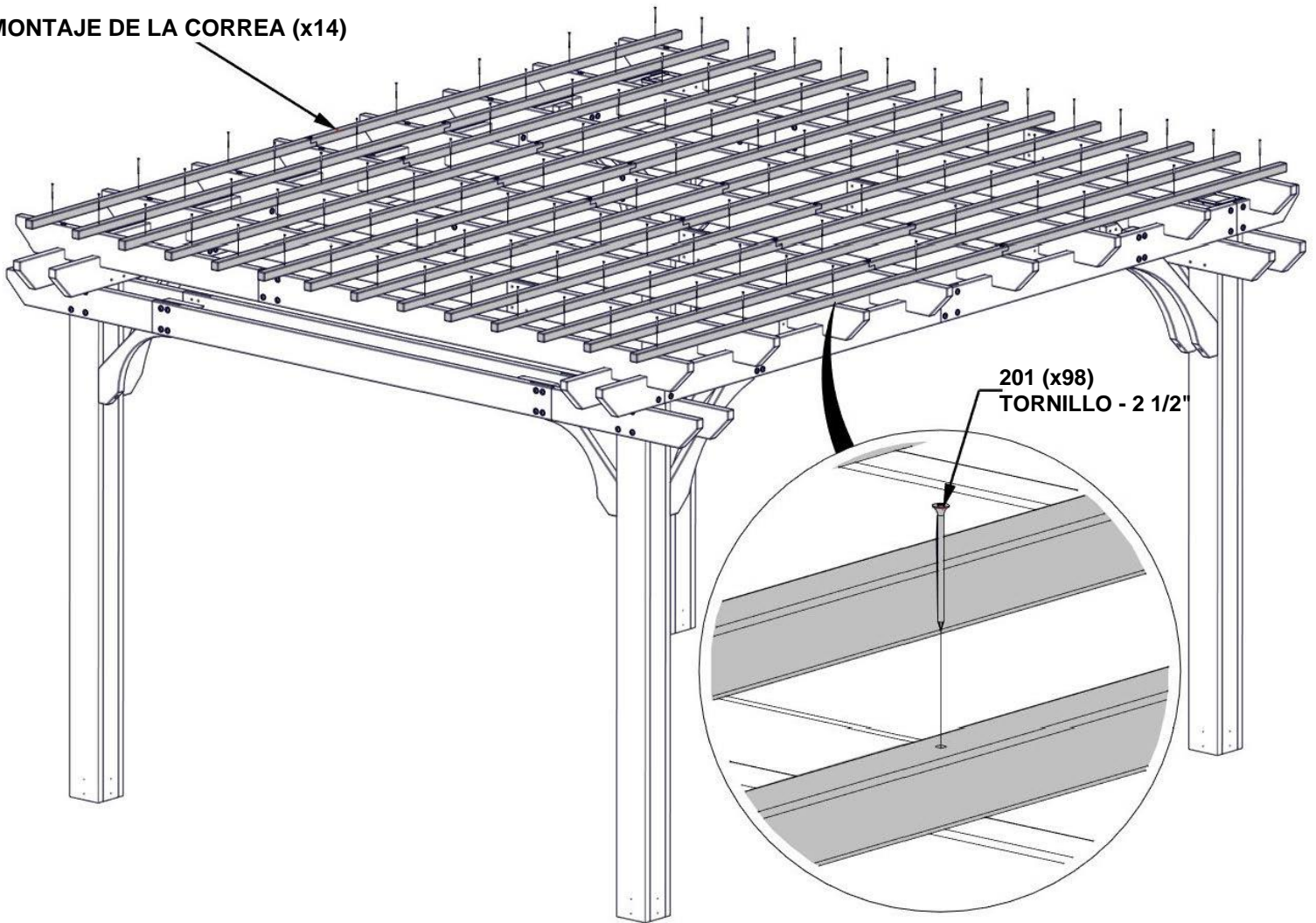

**FIJE EL MONTAJE DE CORREA USANDO LOS ORIFICIOS GUÍA QUE ESTÁN EN EL MONTAJE DE LA VIGUETA RANURADA.**

# PASO 16 - MONTAJE DE LA PÉRGOLA

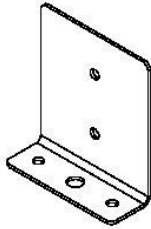

**A4M00977** | PLACA DE ANCLAJE DE POSTE  
(x8)

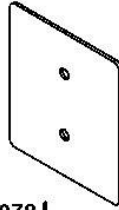

**A4M00978** | PLACA DE POSTE  
(x8)

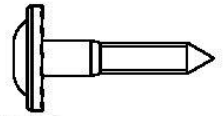

**H100471** | TIRAFONDO BL NG  
(32) | 5/16x1 1/2

**REPITA ESTE PASO PARA CADA POSTE.**

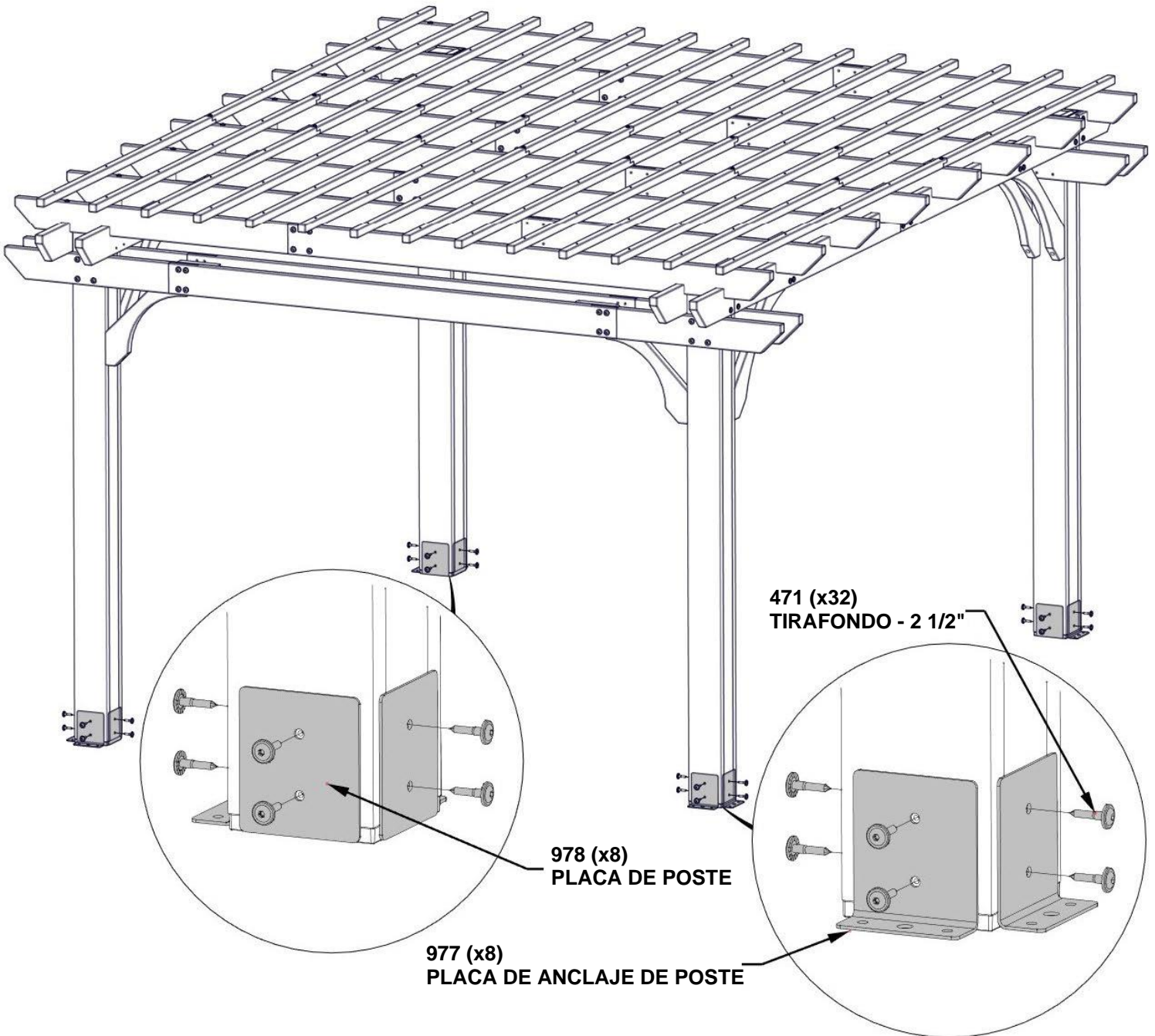

# PASO 17 - MONTAJE DE LA PÉRGOLA



A100241 (1) ETIQUETA DE IDENTIFICACIÓN DE BACKYARD (PEQUEÑA) SIN EDADES



H100202 (2) TORNILLO PWH NG 8x5/8

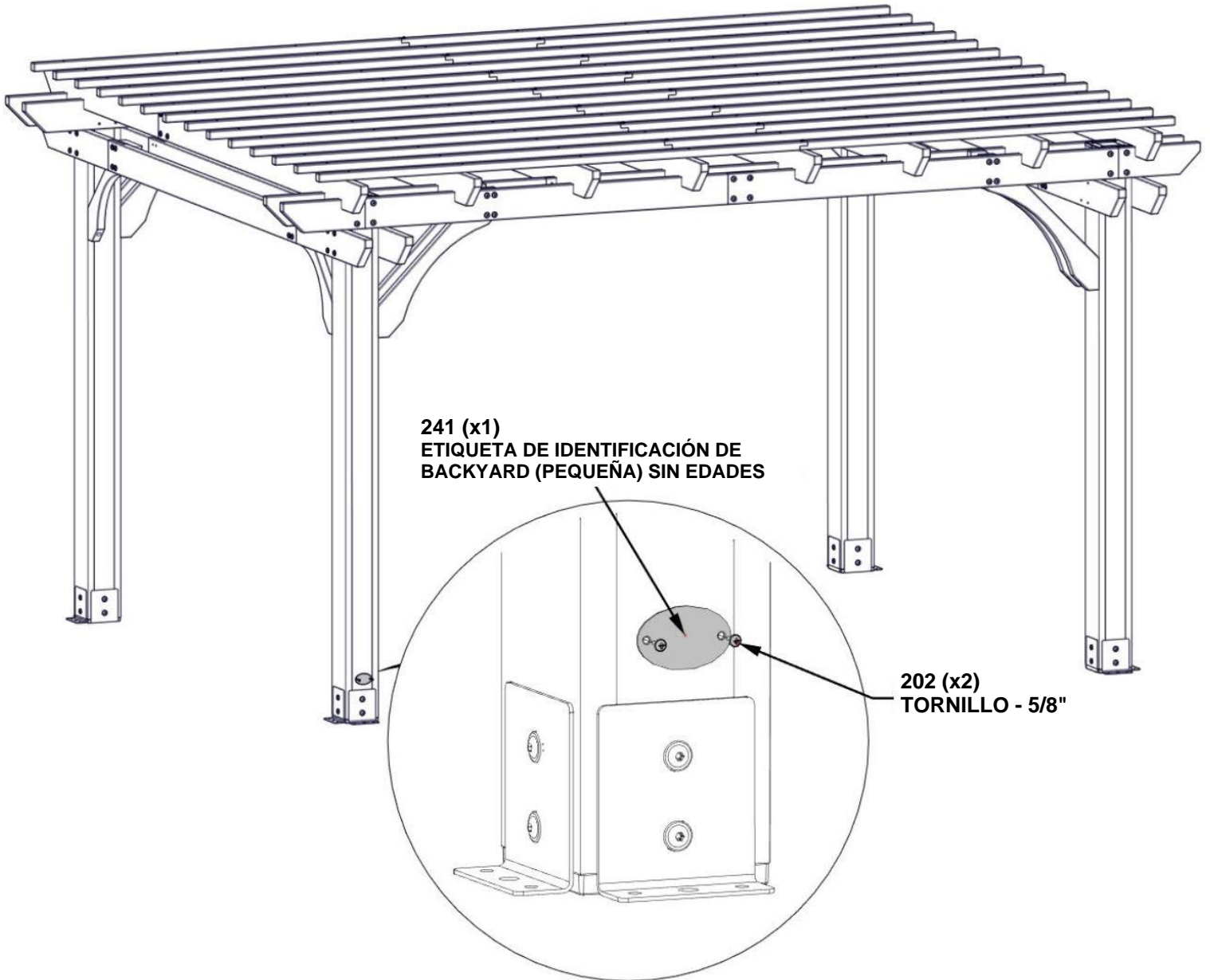

241 (x1) ETIQUETA DE IDENTIFICACIÓN DE BACKYARD (PEQUEÑA) SIN EDADES

202 (x2) TORNILLO - 5/8"



# PASO 18 - MONTAJE DE LA PÉRGOLA

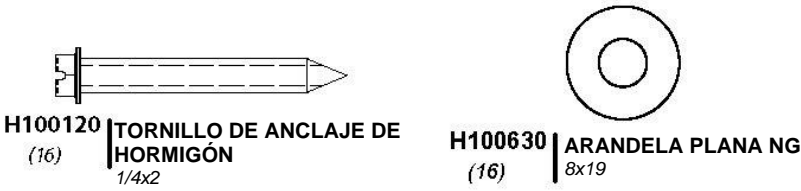

**REPITA ESTE PASO PARA CADA POSTE.**

**EL FABRICANTE RECOMIENDA LA INSTALACIÓN SOBRE UNA SUPERFICIE O UNA LOSA DE HORMIGÓN COMO SE MUESTRA A CONTINUACIÓN.**

**PARA INSTALAR SOBRE PLATAFORMAS DE MADERA, DEBE ASEGURARSE DE QUE EXISTA UN SOPORTE ESTRUCTURAL AMPLIO DEBAJO DE LA PLATAFORMA. NO SE INCLUYEN PIEZAS METÁLICAS PARA LA INSTALACIÓN DE LA CUBIERTA.**

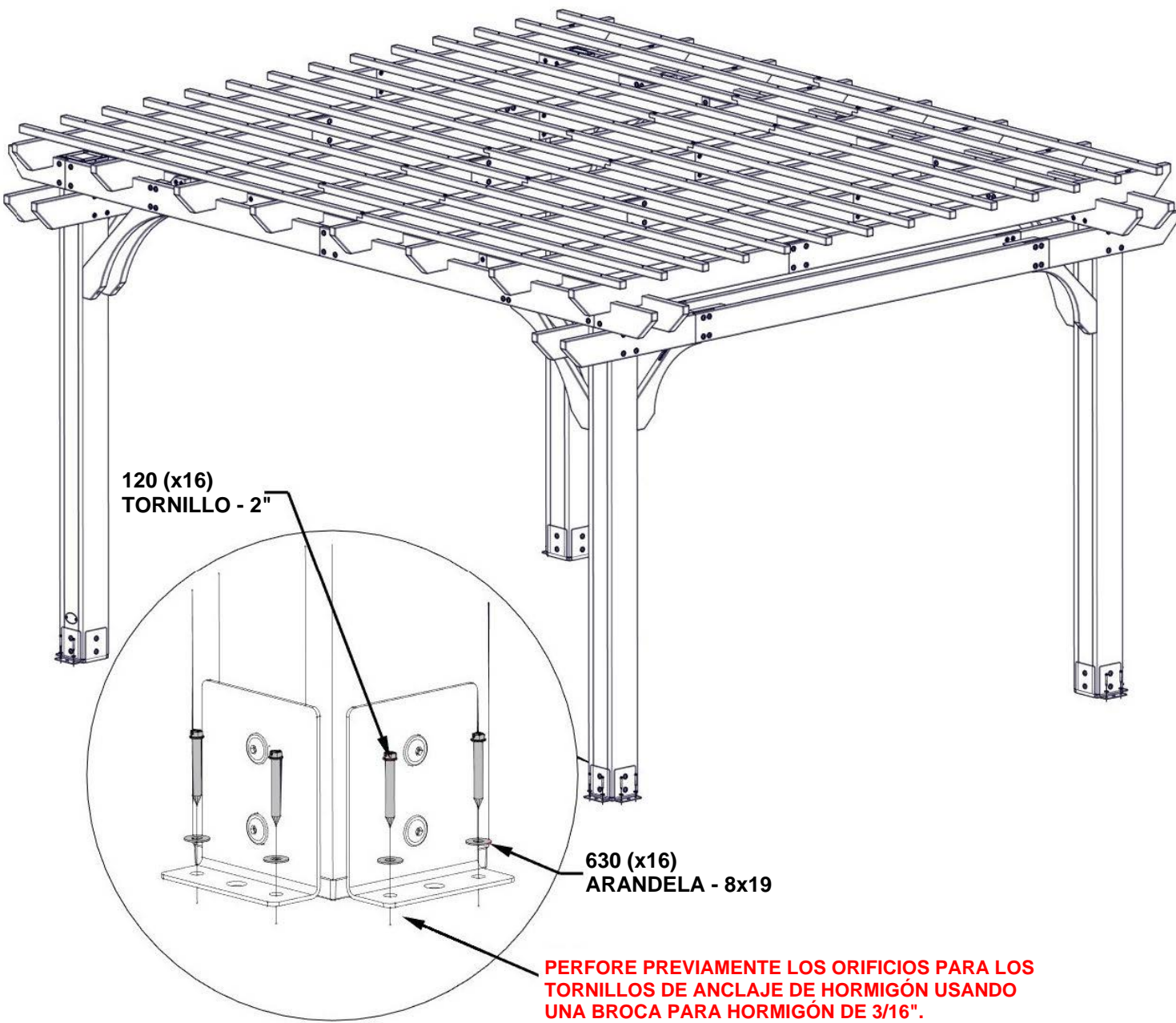

# GABINETE ELÉCTRICO

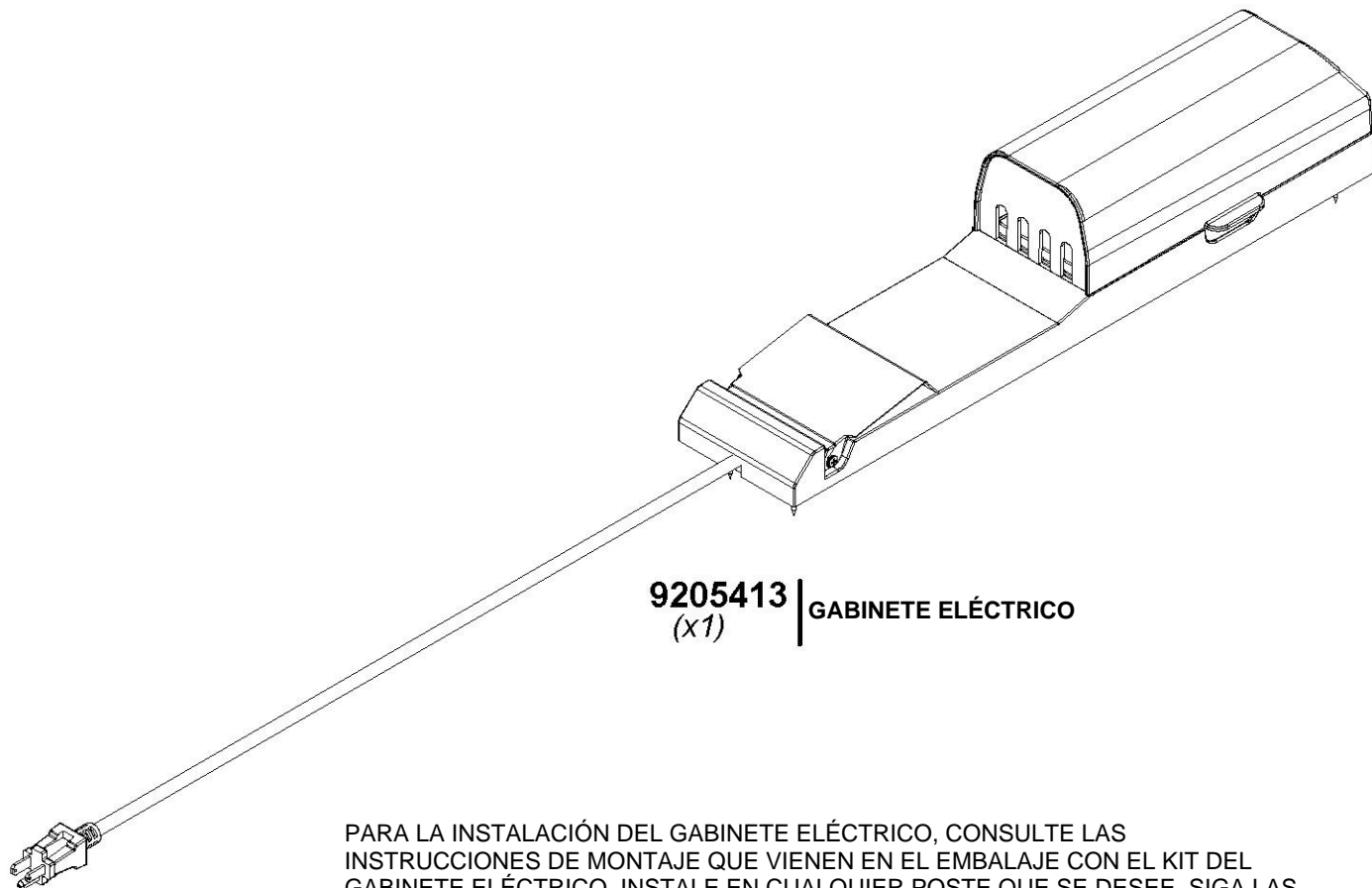

**9205413** | GABINETE ELÉCTRICO  
(x1)

PARA LA INSTALACIÓN DEL GABINETE ELÉCTRICO, CONSULTE LAS INSTRUCCIONES DE MONTAJE QUE VIENEN EN EL EMBALAJE CON EL KIT DEL GABINETE ELÉCTRICO. INSTALE EN CUALQUIER POSTE QUE SE DESEE. SIGA LAS INSTRUCCIONES PARA UNA INSTALACIÓN CORRECTA.