



MANUFACTURED BY:  
Backyard Discovery  
3305 Airport Drive, Pittsburg, KS 66762  
800-856-4445

Basepoint Business Centre: Rivermead Drive, Westlea, Swindon SN5 7EX Phone: 0800-118-2476 J.P.  
Coenstraat 7, The Bridge, The Hague, 2595 WP, Netherlands Phone: 0800-567-8990

# SWEETWATER PLAYHOUSE Model # 2303010 & 2403017

The assembly manual must be retained  
since it contains important information



WARNING  
**Adult Assembly Required.**  
FOR DOMESTIC USE ONLY. INTENDED FOR OUTDOOR USE.  
CAN ICES-003 (B)/NMB-003(B)



**Please visit [www.backyarddiscovery.com](http://www.backyarddiscovery.com)**

For the most up to date assembly manual, to register your set, or to order replacement parts  
*Para obtener instrucciones en español, visite [www.backyarddiscovery.com](http://www.backyarddiscovery.com)*



Selecting the correct location for your play product is important for your children's safety and the product's longevity

- The safe play area refers to a zone extending 6'-7" (2006 mm) beyond the play product on all sides, including the space above the play product.

## SAFE PLAY AREA DIAGRAM

### Ground Dimension

3'-5 7/8" (1065 mm) x 3'-10 5/8" (1186 mm) x 4'-7 3/8" (1405 mm)

### Safe Play Area

16'-7 7/8" (5077 mm) x 17'-5/8" (5198 mm) x 11'-2 1/4" [3411 mm]

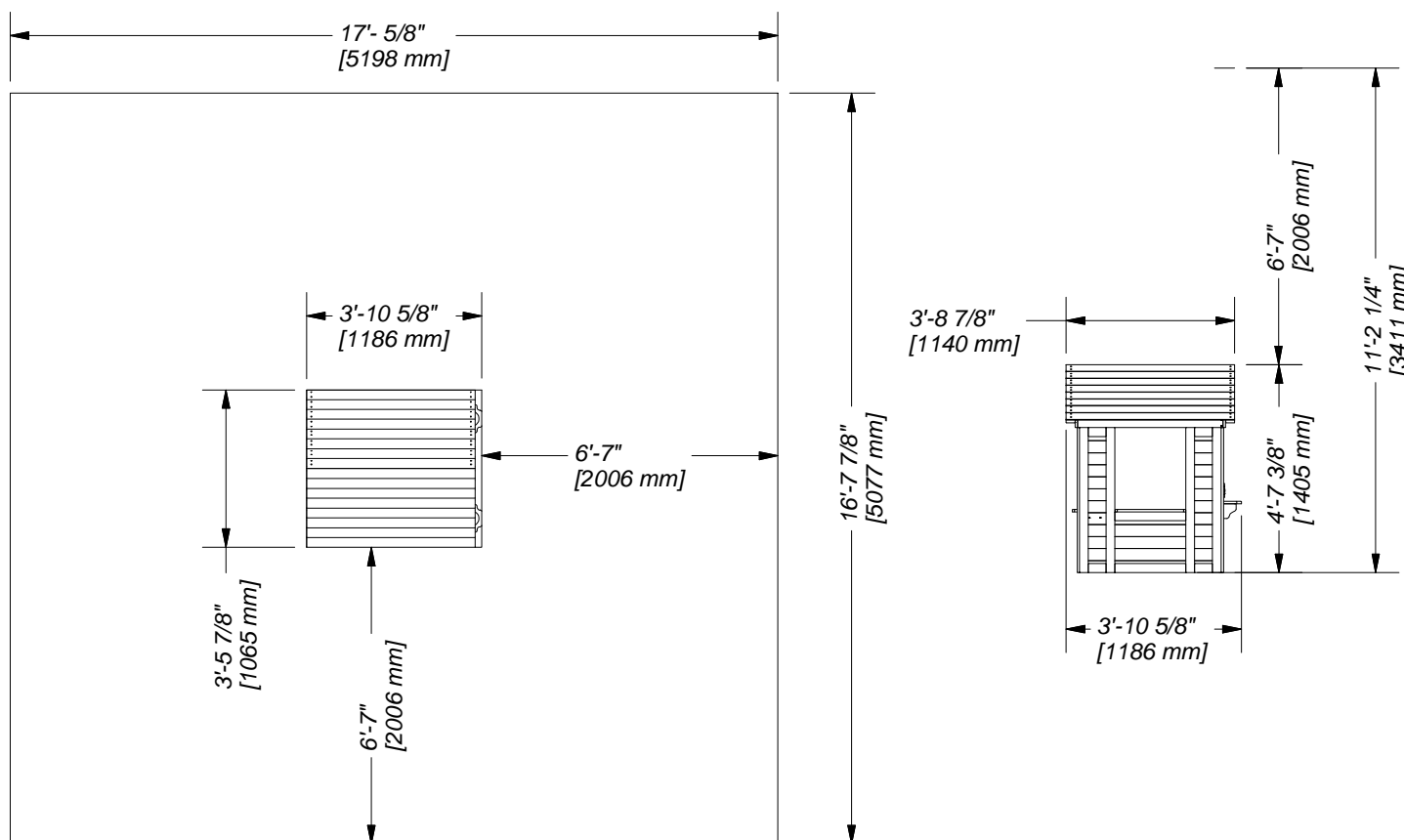

**SAFE PLAY HEIGHT: 11'-2 1/4" [3411 mm]**  
**MAXIMUM FALL HEIGHT: 4' 7-3/8" [1405 mm]**

### General Information:

Your set has been designed and engineered for children only and for residential use only. A maximum of 5 children is recommended for this playhouse.

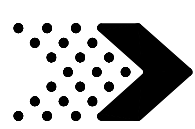

CLASS B DIGITAL DEVICE STATEMENT

**Note:**

This equipment has been tested and found to comply with the limits for a Class B digital device, pursuant to part 15 of the FCC Rules. These limits are designed to provide reasonable protection against harmful interference in a residential installation. This equipment generates, uses and can radiate radio frequency energy and, if not installed and used in accordance with the instructions, may cause harmful interference to radio communications. However, there is no guarantee that interference will not occur in a particular installation. If this equipment does cause harmful interference to radio or television reception, which can be determined by turning the equipment off and on, the user is encouraged to try to correct the interference by one or more of the following measures:

- Reorient or relocate the receiving antenna.
- Increase the separation between the equipment and receiver.
- Connect the equipment into an outlet on a circuit different from that to which the receiver is connected.
- Consult the dealer or an experienced radio/TV technician for help

Caution: Changes or modifications not expressly approved by the party responsible for compliance could void the user's authority to operate the equipment.



## Wood Components (Not to Scale)



**D1** | COUNTER TOP SUPPORT - W4L17067  
(x1) | 1 3/8"x4 3/8"x5 7/8" (36x112x150)



**J1** | COUNTER TOP SUPPORT - W4L17068  
(x2) | 1"x2 3/8"x5 7/8" (24x60x150)

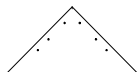

**K1** | TRIANGLE SUNBURST - W4L17069  
(x2) | 5/8"x5 1/4"x10 3/8" (16x134x265)

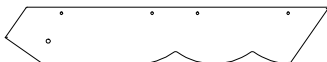

**L1** | GABLE BOARD - W4L17070  
(x4) | 5/8"x4 3/8"x25 3/8" (16x112x643)



**M1** | COUNTER TOP - W4L17071  
(x4) | 5/8"x3 3/8"x18 1/2" (16x86x469)

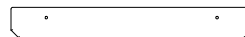

**N1** | SIDE WINDOW SHELF - W4L17072  
(x2) | 5/8"x2 3/8"x18 7/8" (16x60x479)

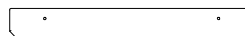

**N2** | REAR WINDOW SHELF - W4L17073  
(x1) | 5/8"x2 3/8"x19 1/8" (16x60x485)



**N3** | DOOR STOP - W4L17074  
(x1) | 5/8"x2 3/8"x3 7/8" (16x60x100)



**N4** | TIE STRAP - W4L17075  
(x8) | 5/8"x2"x3 1/8" (16x50x80)



**N5** | SUNBURST LEG - W4L17076  
(x2) | 5/8"x2 3/8"x9 7/8" (16x60x250)

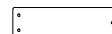

**N6** | SUNBURST LEG - W4L17077  
(x4) | 5/8"x2 3/8"x8 1/4" (16x60x210)

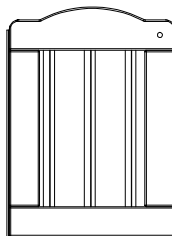

**DP1** | DOOR ASSEMBLY - W2A03681  
(x1) | 1 1/4"x13 1/8"x17 15/16" (32x334x456)

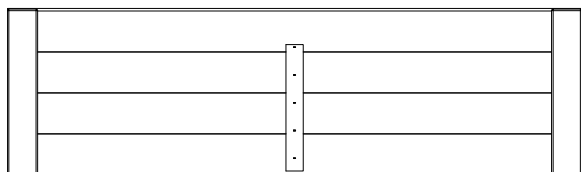

**RP1** | LOWER ROOF PANEL - W2A02982  
(x2) | 1 3/8"x13"x44 7/8" (35x329x1140)

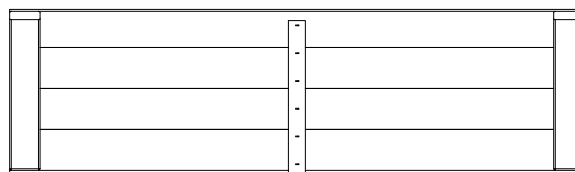

**RP2** | UPPER ROOF PANEL - W2A02983  
(x2) | 1 3/8"x12 3/4"x44 7/8" (35x324x1140)

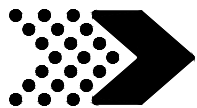

Wood Components (Not to Scale)

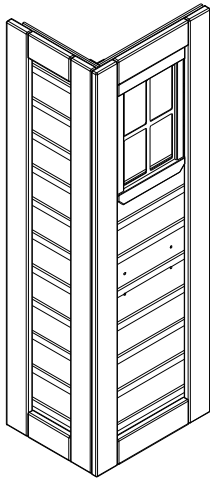

**WP1** | LEFT FRONT CORNER PANEL - W2A03682  
(x1) | LENGTH 38 9/16" (980)

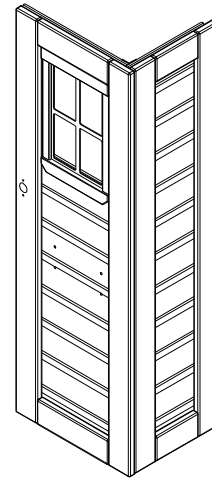

**WP2** | RIGHT FRONT CORNER PANEL - W2A03685  
(x1) | LENGTH 38 9/16" (980)

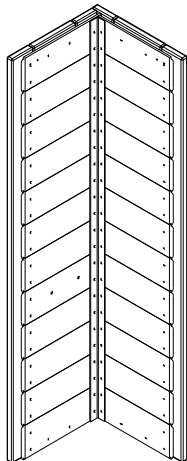

**WP3** | LEFT REAR CORNER PANEL - W2A03688  
(x1) | LENGTH 38 9/16" (980)

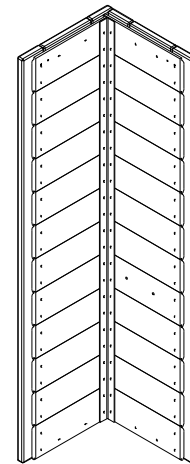

**WP4** | RIGHT REAR CORNER PANEL - W2A03691  
(x1) | LENGTH 38 9/16" (980)

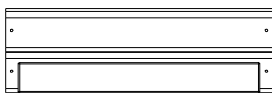

**WP5** | LOWER CENTER WALL - W2A03694  
(x2) | 1 1/2"x6 9/16"x20 7/8" (38x167x530)

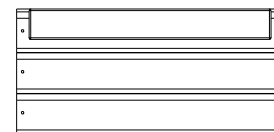

**WP6** | UPPER CENTER WALL - W2A03695  
(x2) | 1 1/2"x9 3/4"x20 7/8" (38x248x530)

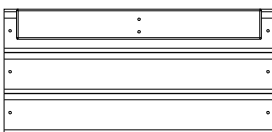

**WP7** | UPPER REAR CENTER WALL - W2A03696  
(x1) | 1 1/2"x9 3/4"x21 1/8" (38x248x536)



**WP8** | LOWER REAR CENTER WALL - W2A03697  
(x1) | 1 1/2"x6 9/16"x21 1/8" (38x167x536)

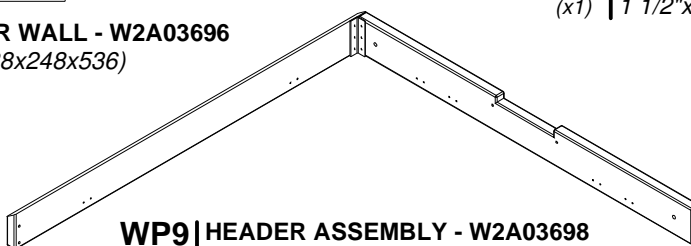

**WP9** | HEADER ASSEMBLY - W2A03698  
(x2) | 3 3/8"x37 7/8"x38 7/8" (86x962x986)



## Hardware Components

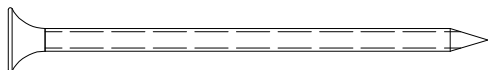

**H100090 | SCREW PFH**  
(x6) | 8x2 1/2"

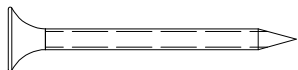

**H100086 | SCREW PFH**  
(x22) | 8x1 1/2

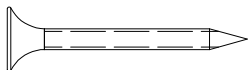

**H100087 | SCREW PFH**  
(x53) | 8x1 1/4



**H100088 | SCREW PFH**  
(x30) | 8x1 1/8



**H100085 | SCREW PFH**  
(x38) | 8x1

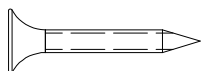

**H100537 | SCREW PFH SD**  
(x2) | 8x1

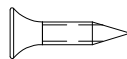

**H100624 | SCREW PFH BLK**  
(x2) | 6x5/8

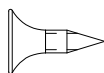

**H100124 | SCREW PFH**  
(x2) | 8 x 1/2

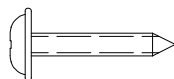

**H100070 | SCREW PWH**  
(x8) | 8x3/4

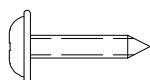

**H100128 | SCREW PWH**  
(x2) | 8x5/8

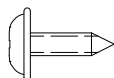

**H100361 | SCREW PWH**  
(x2) | 8x7/16

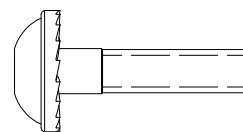

**H100137 | BOLT WH**  
(x4) | 1/4x1

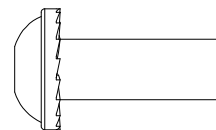

**H100140 | NUT BARREL WH**  
(x4) | 1/4x7/8

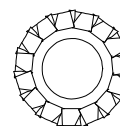

**H100138 | WASHER LOCK EXT**  
(x4) | 6x15

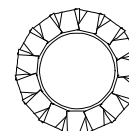

**H100139 | WASHER LOCK EXT**  
(x4) | 8x15

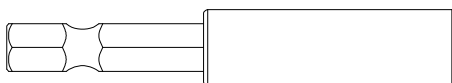

**H101100 | MAGNETIC DRIVER**  
(x1)

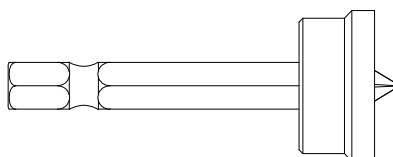

**H100764 | SCREW SETTER**  
(x1)

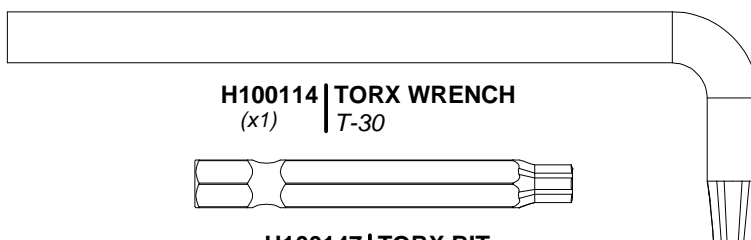

**H100114 | TORX WRENCH**  
(x1) | T-30

**H100147 | TORX BIT**  
(x1) | T-30



Accessory Components (Not to Scale)

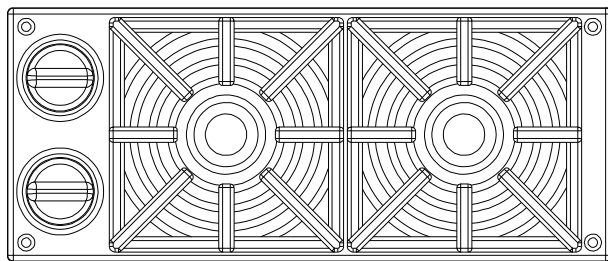

A6P00025 | STOVE KIT  
(x1)

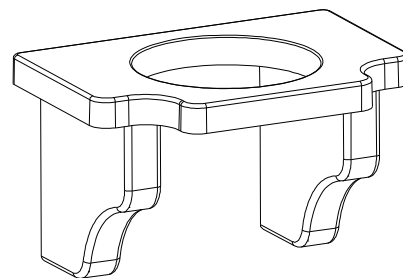

A6P00387 | FLOWER POT HOLDER - BLK  
(x2)

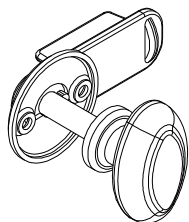

A6P00020 | KNOB KIT  
(x1)

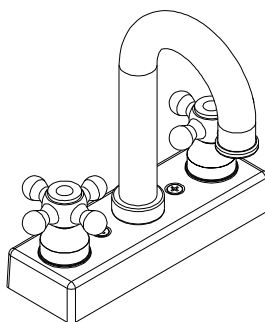

A6P00024 | FAUCET KIT  
(x1)

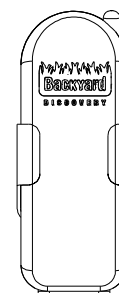

A100132 | PHONE KIT  
(x1)



BE SURE TO WASH ALL PLASTIC TOYS BEFORE USE.

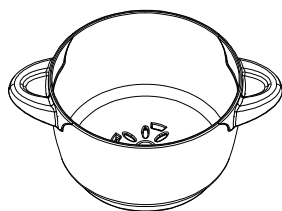

A6P00336 | BOIL POT  
(x1)

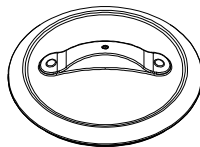

A6P00337 | POT/PAN LID  
(x1)

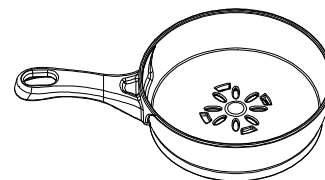

A6P00338 | FRY PAN  
(x1)

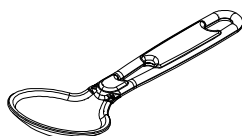

A6P00340 | LADLE  
(x1)

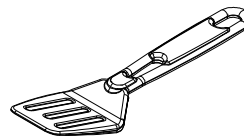

A6P00339 | SPATULA  
(x1)



Accessory Components (Not to Scale)



A4M00517 | METAL TIE STRAP  
(x1)

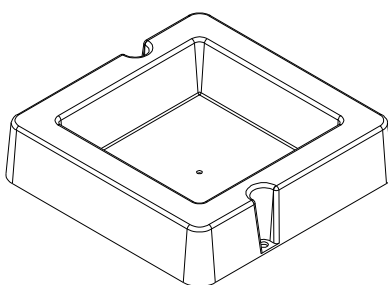

A6P00032 | SURFACE MOUNT BASIN  
(x1)



A4M00528 | BYD ID TAG (MEDIUM) AGES 2 TO 10  
(x1)

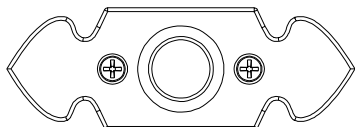

A6P00290 | DOOR BELL PLATE  
(x1)

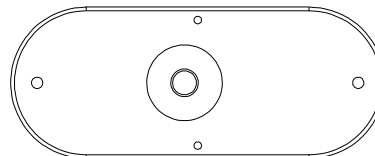

A100174 | DOOR BELL  
(x1)



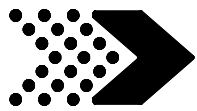

# STEP 1

## PRE-ASSEMBLY - SORTING PARTS

It is critical for ease of assembly that you take the time to sort and organize the wood and hardware.

---

### WOOD PARTS:

- Organize wood parts by the three-digit, alpha-numeric number stamped on each board (ex. P01).
- If there are multiple boards with the same stamped number, stack those pieces together.
- Stamps can be found on the flat surface of the boards or on the end of the boards.
- Allow yourself plenty of room - the wood pieces can take up a significant amount of space.
- Resin coming from the knots in the wood pieces is natural and does not affect the quality of the wood, but could cause yellowing around the knots.

**NOTE: CARTONS ARE NOT ORGANIZED BY BOARD NUMBER.**

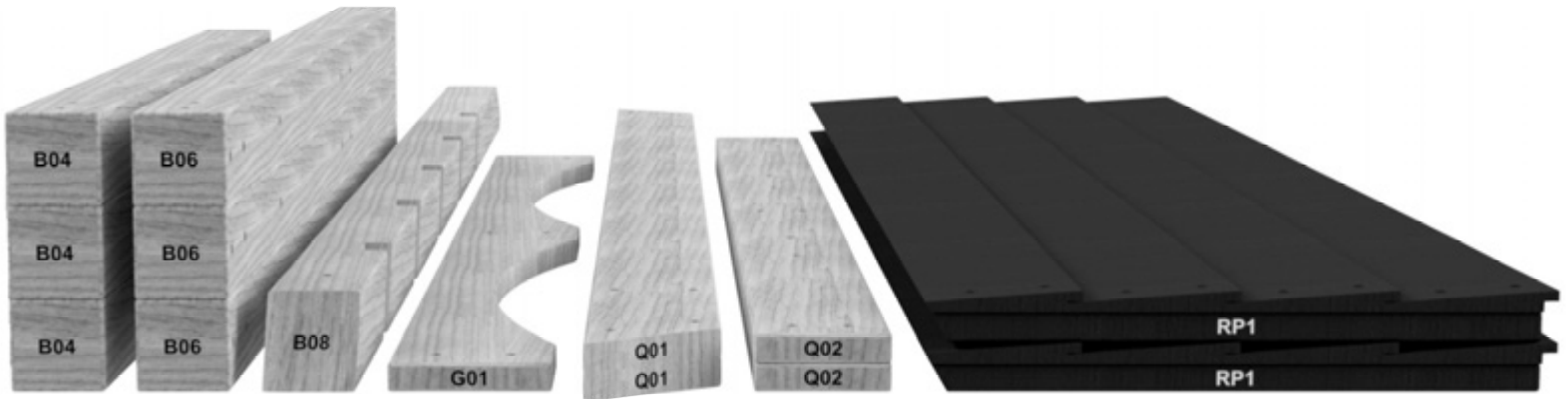

### HARDWARE PARTS:

- We recommend that you have a separate table to organize the hardware.
- Hardware bags are printed with a seven-digit, alpha-numeric part number.
- You can organize your hardware by part number or group by hardware type (i.e. bolts, nuts, etc.).
- During assembly you only need to reference the last four digits of the number.



H100194 | BOLT WH  
(x2) ↑ 5/16 x 2-1/2

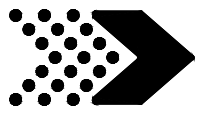

## STEP 2

### PRE-ASSEMBLY - TOOLS REQUIRED



Cordless Drill or  
Electric Drill



Drill Attachments:  
Phillips Head



1/8", 3/16", 3/8" & 7/16"  
Drill Bits



Phillips Screw Driver



Open End Wrenches 1/2" & 9/16"



3/8" Drive Ratchet, 1/2" &  
9/16" STD Sockets 1/2" & 9/16" Deep  
Sockets



Claw Hammer



Rubber Mallet - Optional



Tape Measure

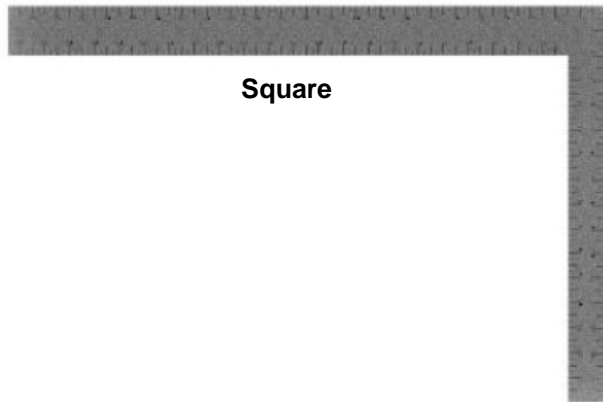

Square



Level 24"

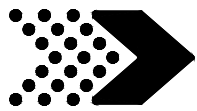

# STEP 1

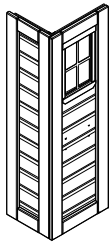

**WP1** | LEFT FRONT CORNER PANEL - W2A03682  
(x1) | LENGTH 38 9/16" (980)

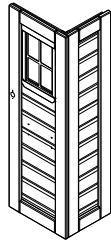

**WP2** | RIGHT FRONT CORNER PANEL - W2A03685  
(x1) | LENGTH 38 9/16" (980)

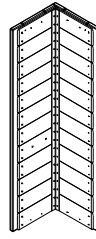

**WP3** | LEFT REAR CORNER PANEL - W2A03688  
(x1) | LENGTH 38 9/16" (980)

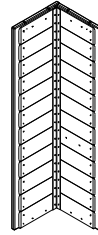

**WP4** | RIGHT REAR CORNER PANEL - W2A03691  
(x1) | LENGTH 38 9/16" (980)



**NOTE:**  
POSITION WALL PANELS AS SHOWN BELOW. VERIFY THE CORRECT PANEL PLACEMENT BY CHECKING THE HOLE LOCATIONS AS SHOWN BELOW.

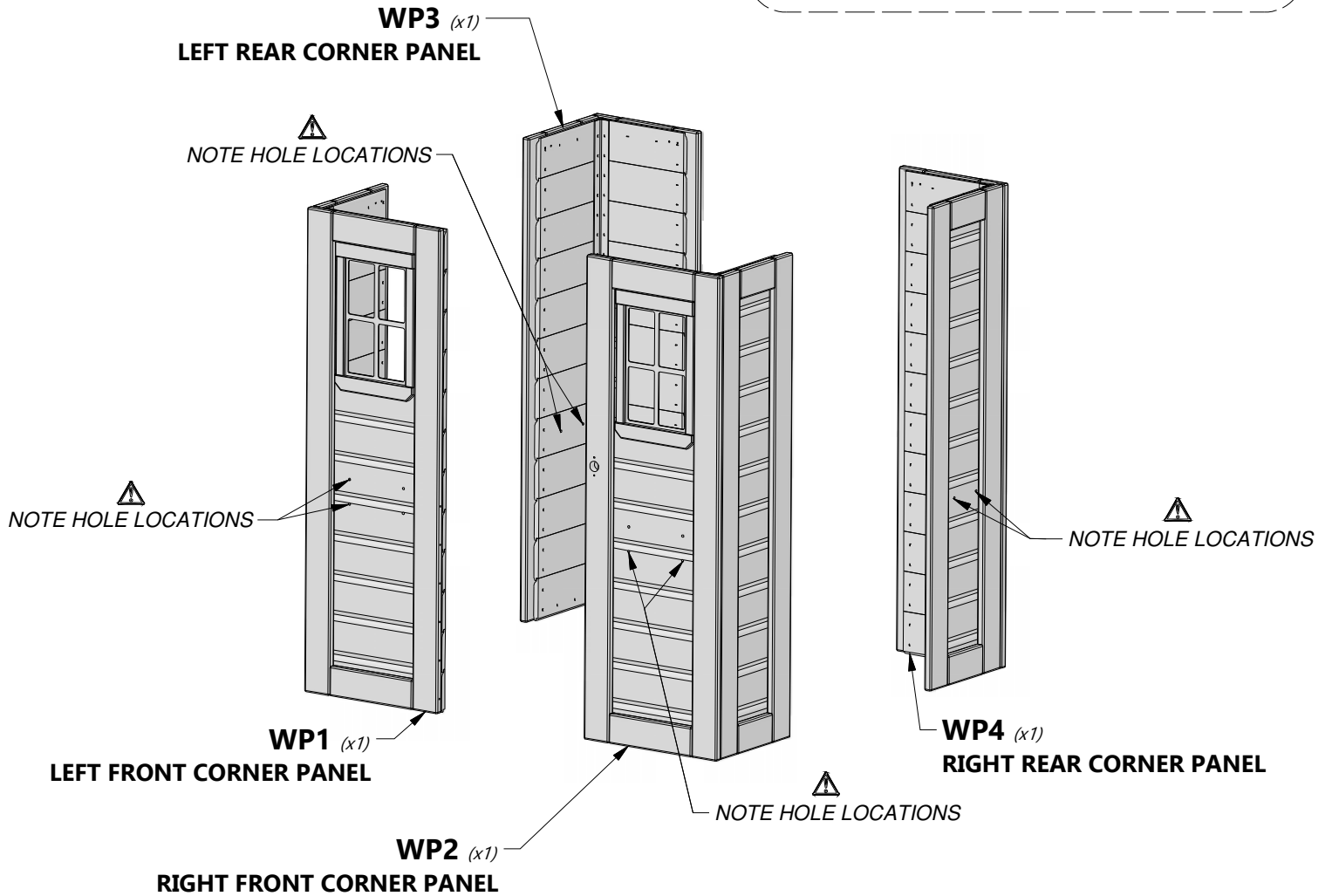

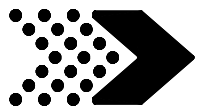

# STEP 2

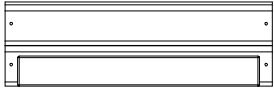

**WP5** | LOWER CENTER WALL - W2A03694  
(x1) | 1 1/2"x6 9/16"x20 7/8" (38x167x530)

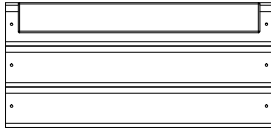

**WP6** | UPPER CENTER WALL - W2A03695  
(x1) | 1 1/2"x9 3/4"x20 7/8" (38x248x530)



**H100085** | SCREW PFH  
(x10) | 8x1



**NOTE:**

ALIGN PANELS AS SHOWN BELOW THEN PRE-DRILL PILOT HOLES USING AN 1/8" [3 mm] DRILL BIT, 1/2" [12 mm] DEEP FOR HARDWARE.

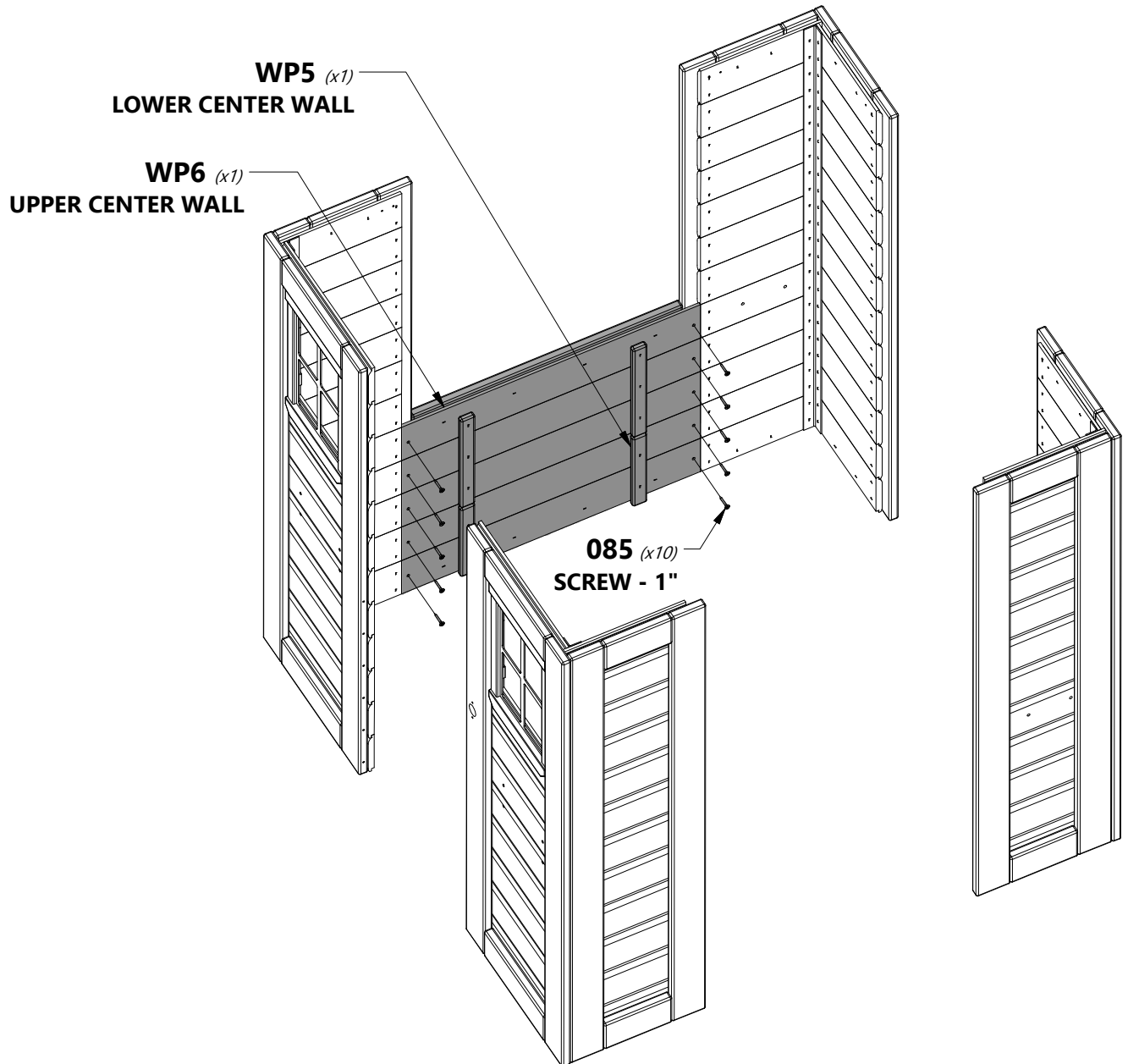

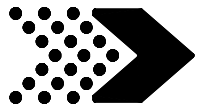

# STEP 3

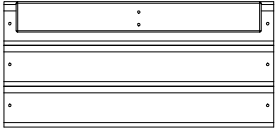

**WP7** | UPPER REAR CENTER WALL - W2A03696  
(x1) | 1 1/2"x9 3/4"x21 1/8" (38x248x536)

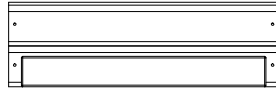

**WP8** | LOWER REAR CENTER WALL - W2A03697  
(x1) | 1 1/2"x6 9/16"x21 1/8" (38x167x536)



**H100085** | SCREW PFH  
(x10) | 8x1



## NOTE:

ALIGN PANELS AS SHOWN BELOW THEN PRE-DRILL PILOT HOLES USING AN 1/8" [3 mm] DRILL BIT, 1/2" [12 mm] DEEP FOR HARDWARE.

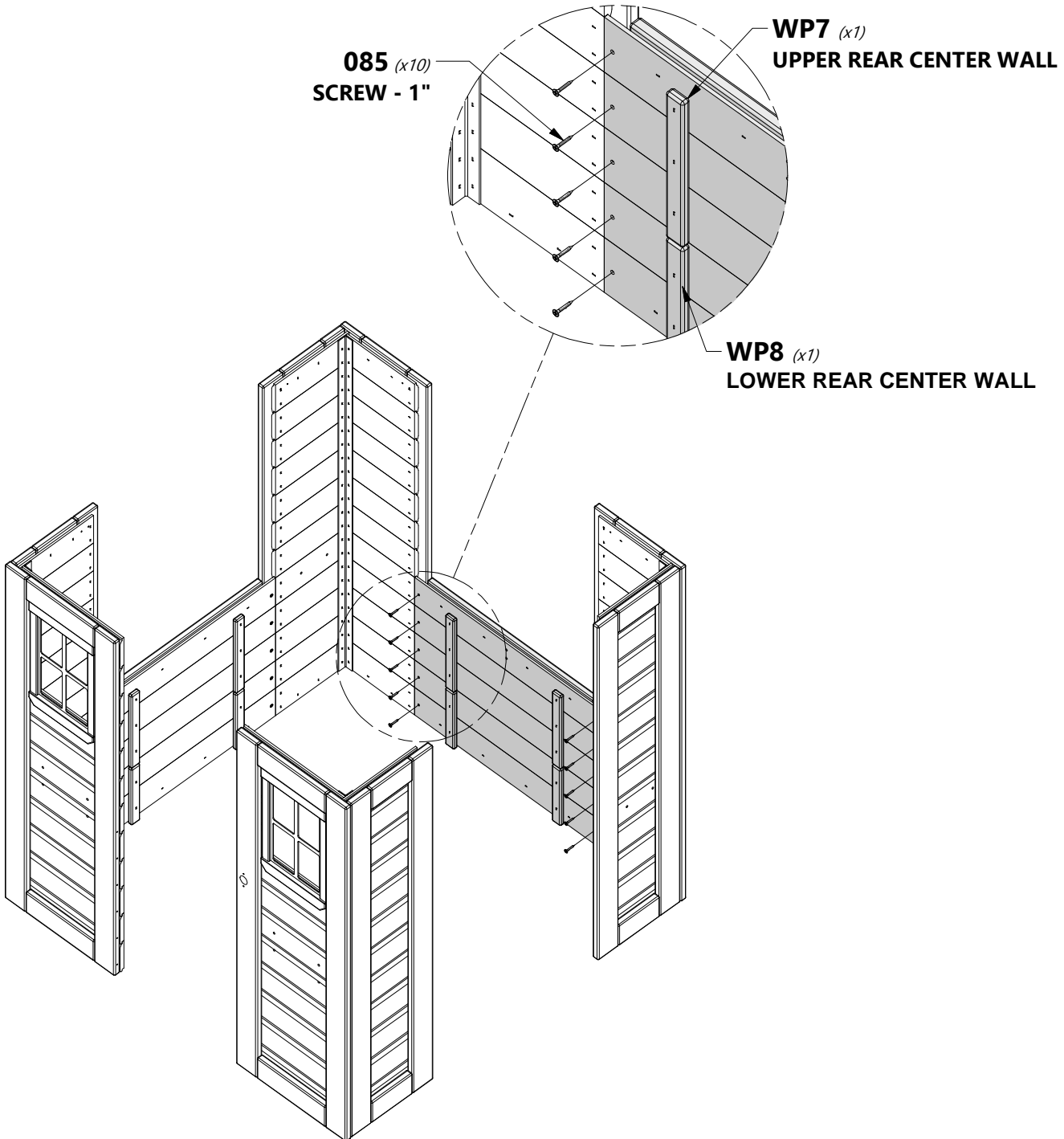

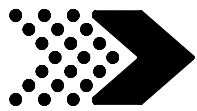

# STEP 4

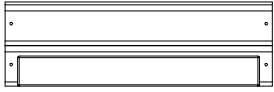

**WP5** | LOWER CENTER WALL - W2A03694  
(x1) | 1 1/2"x6 9/16"x20 7/8" (38x167x530)

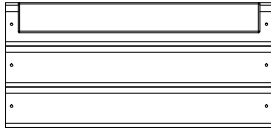

**WP6** | UPPER CENTER WALL - W2A03695  
(x1) | 1 1/2"x9 3/4"x20 7/8" (38x248x530)

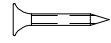

**H100085** | SCREW PFH  
(x10) | 8x1



### NOTE:

ALIGN PANELS AS SHOWN BELOW THEN PRE-DRILL PILOT HOLES USING AN 1/8" [3 mm] DRILL BIT, 1/2" [12 mm] DEEP FOR HARDWARE.

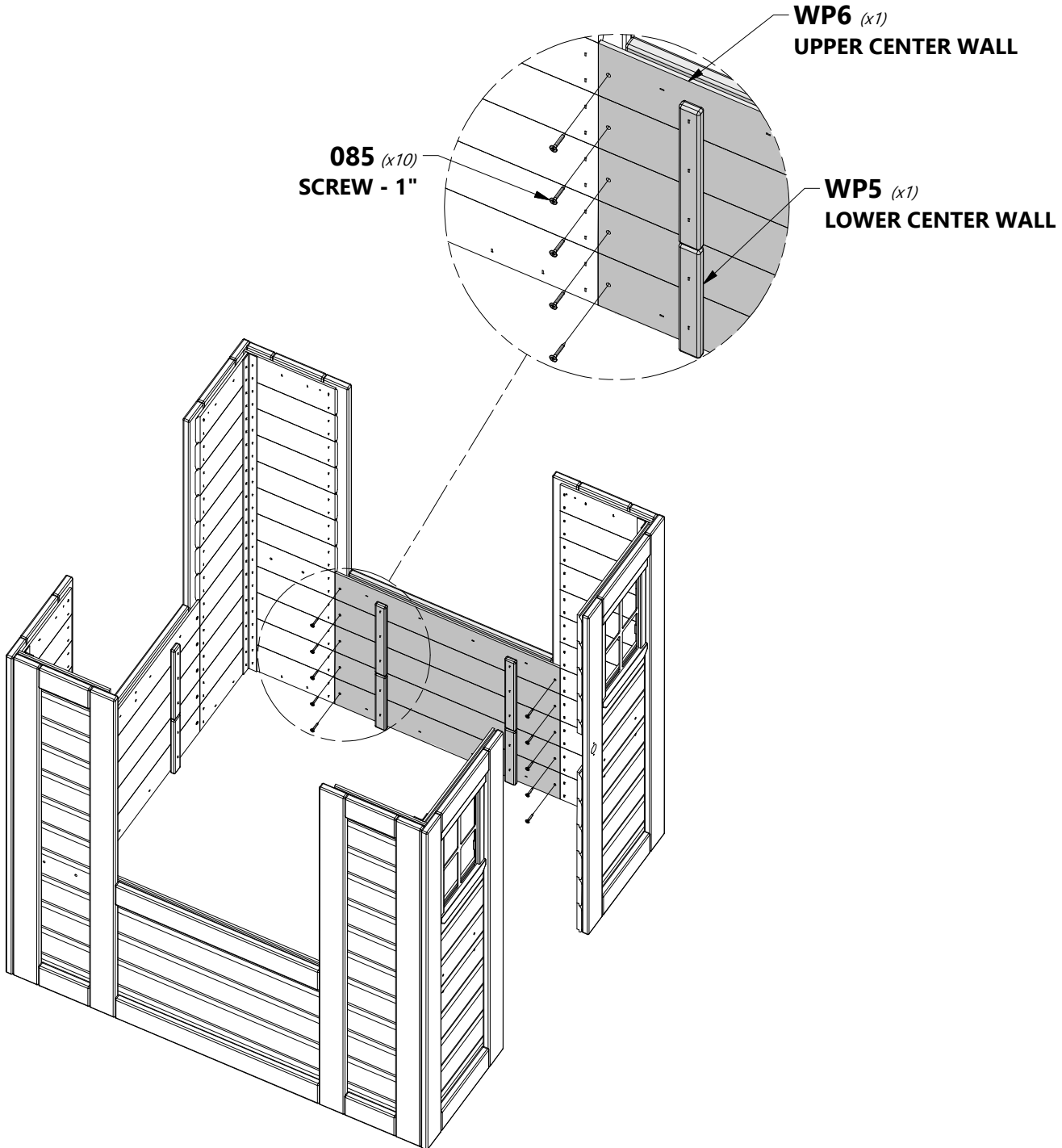

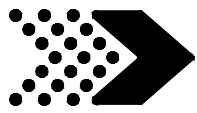

# STEP 5

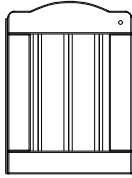

**DP1 | DOOR ASSEMBLY - W2A03681**  
(x1) | 1 1/4"x13 1/8"x17 15/16" (32x334x456)



**H100088 | SCREW PFH**  
(x6) | 8x1 1/8

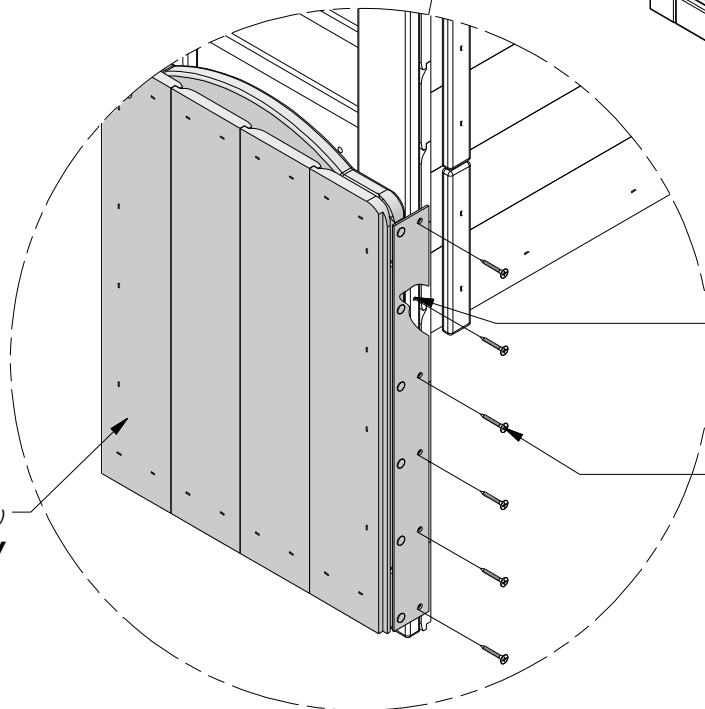
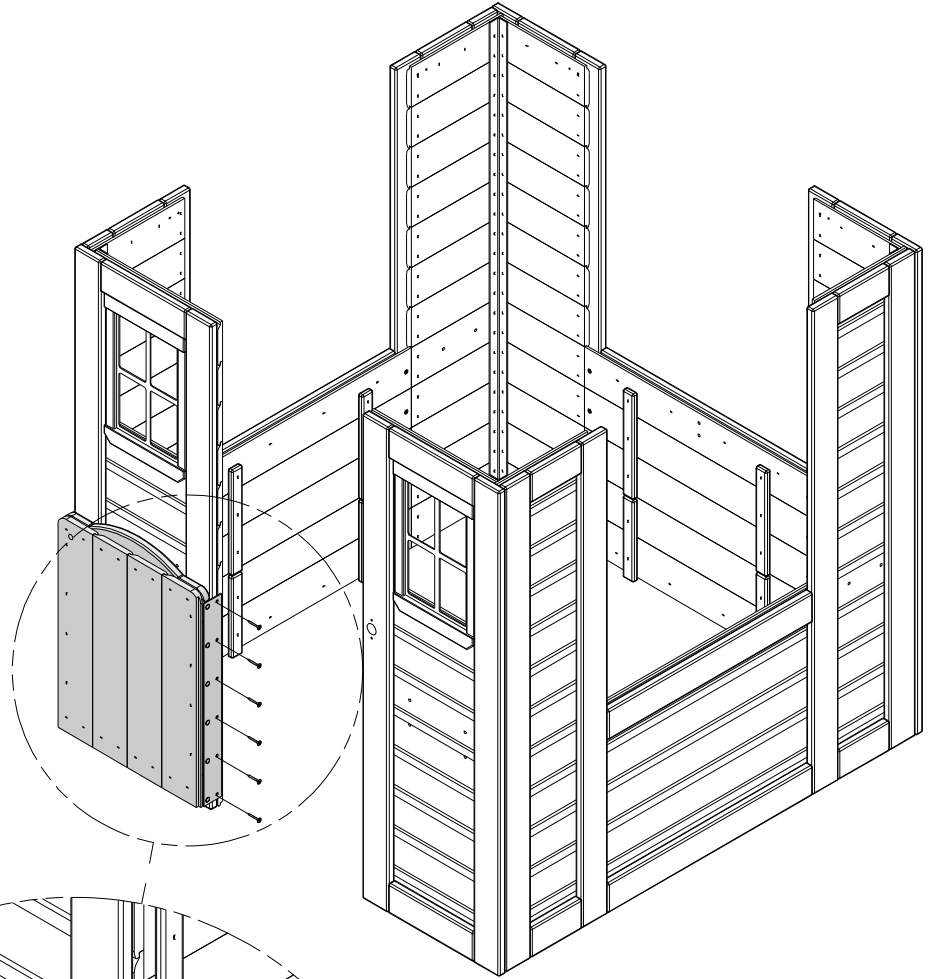
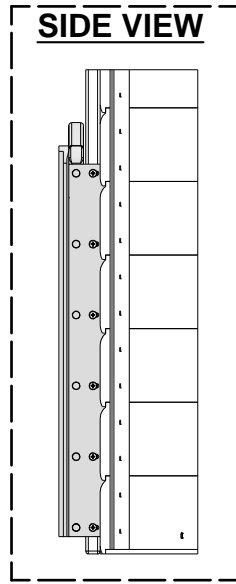

NOTE PILOT HOLES

**088 (x6)**  
**SCREW - 1 1/8"**

**DP1 (x1)**  
**DOOR ASSEMBLY**

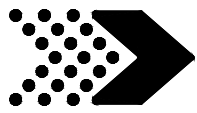

# STEP 6



**A4M00517** | METAL TIE STRAP  
*(x1)*



**H100070** | SCREW PWH  
*(x8)* | 8x3/4



**TIP:**  
ALIGN TIE STRAP WITH PILOT HOLES AND ASSEMBLE AS SHOWN.

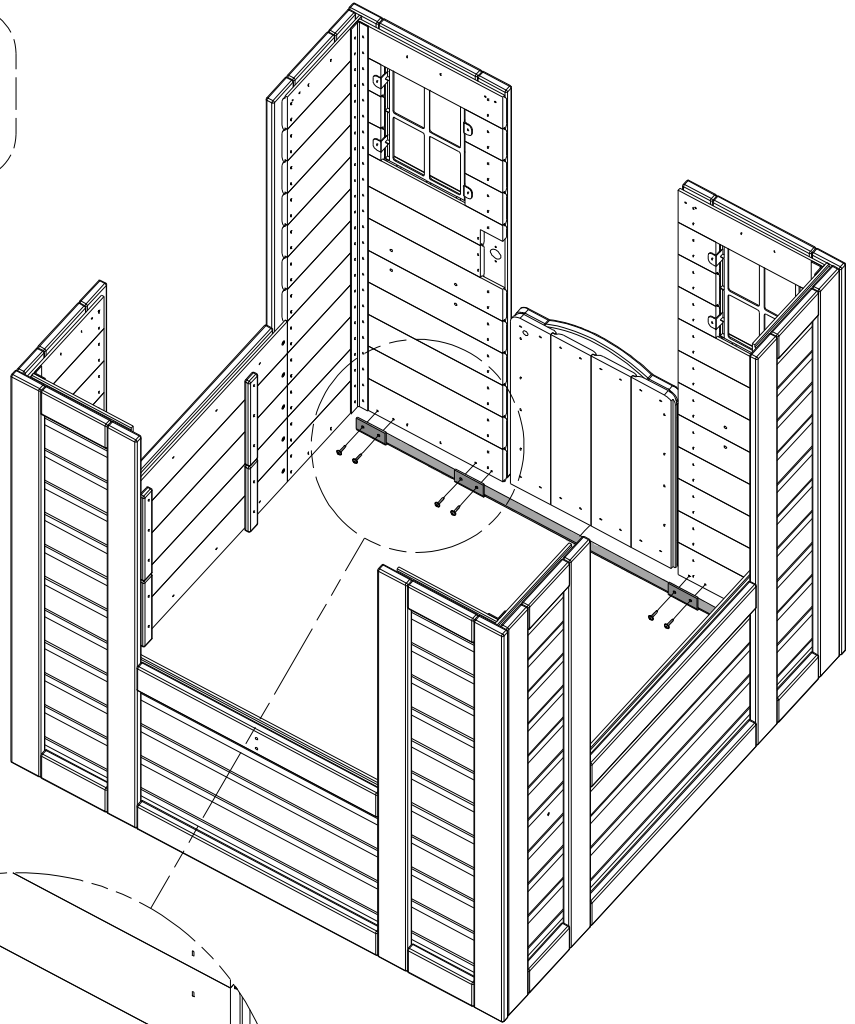

 NOTE PILOT HOLES

**070** *(x8)*  
SCREW - 8x3/4"

**517** *(x1)*  
METAL TIE STRAP



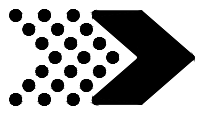

# STEP 7

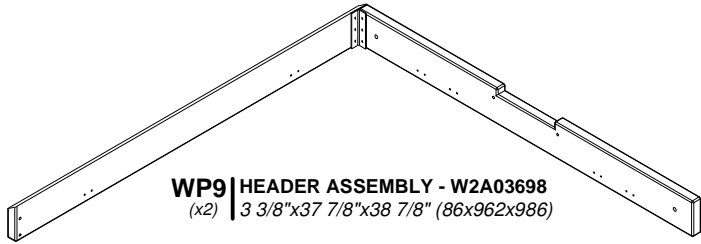

**WP9 | HEADER ASSEMBLY - W2A03698**  
(x2) | 3 3/8"x37 7/8"x38 7/8" (86x962x986)

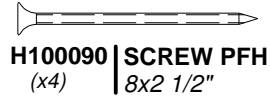

**H100090 | SCREW PFH**  
(x4) | 8x2 1/2"



### NOTE:

REST HEADER ASSEMBLIES ON THE WALL PANELS AND ASSEMBLY AS SHOWN.

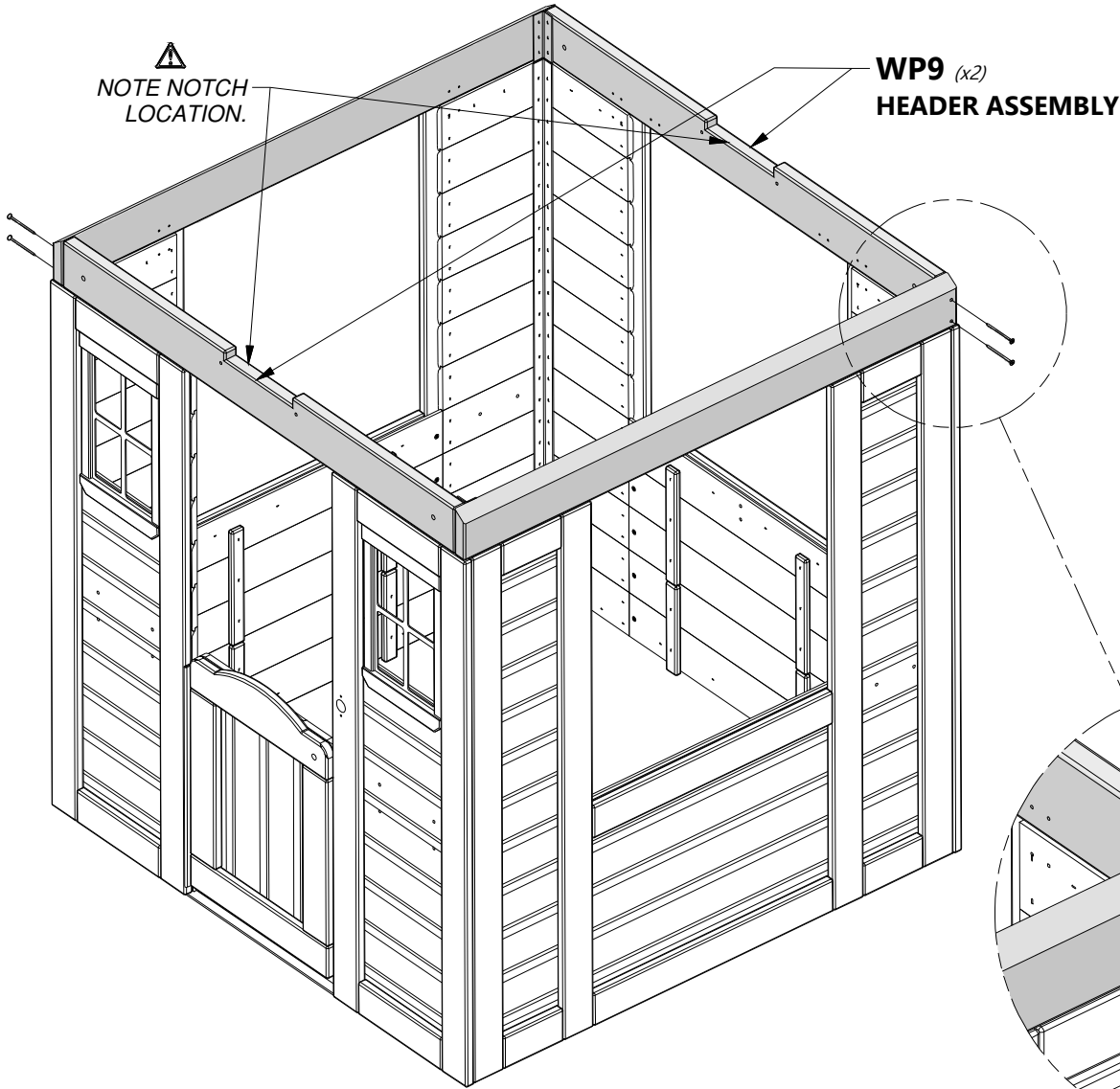

 NOTE NOTCH LOCATION.

**WP9 (x2)**  
**HEADER ASSEMBLY**

**090 (x4)**  
**SCREW - 2 1/2"**

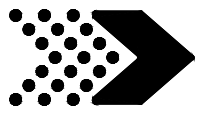

# STEP 8

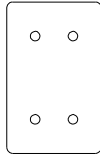

**N4** | TIE STRAP - W4L17075  
(x8) | 5/8"x2"x3 1/8" (16x50x80)



**H100087** | SCREW PFH  
(x32) | 8x1 1/4

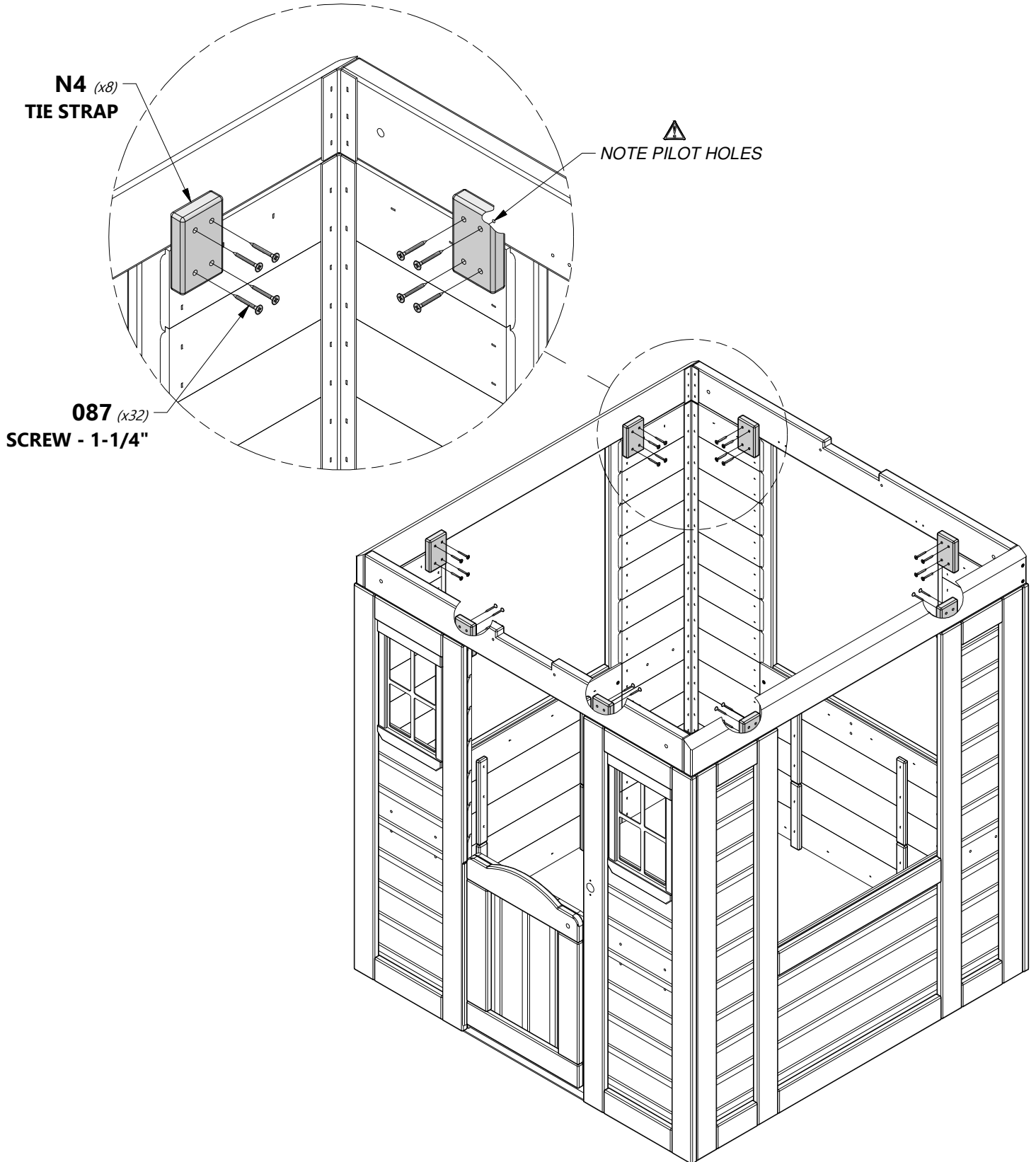

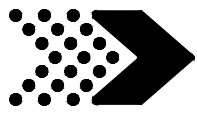

# STEP 9

**L1** | GABLE BOARD - W4L17070  
 (x4) | 5/8"x4 3/8"x25 3/8" (16x112x643)

**H100137** | BOLT WH  
 (x4) | 1/4x1

**H100138** | WASHER LOCK EXT  
 (x4) | 6x15

**H100139** | WASHER LOCK EXT  
 (x4) | 8x15

**H100140** | NUT BARREL WH  
 (x4) | 1/4x7/8

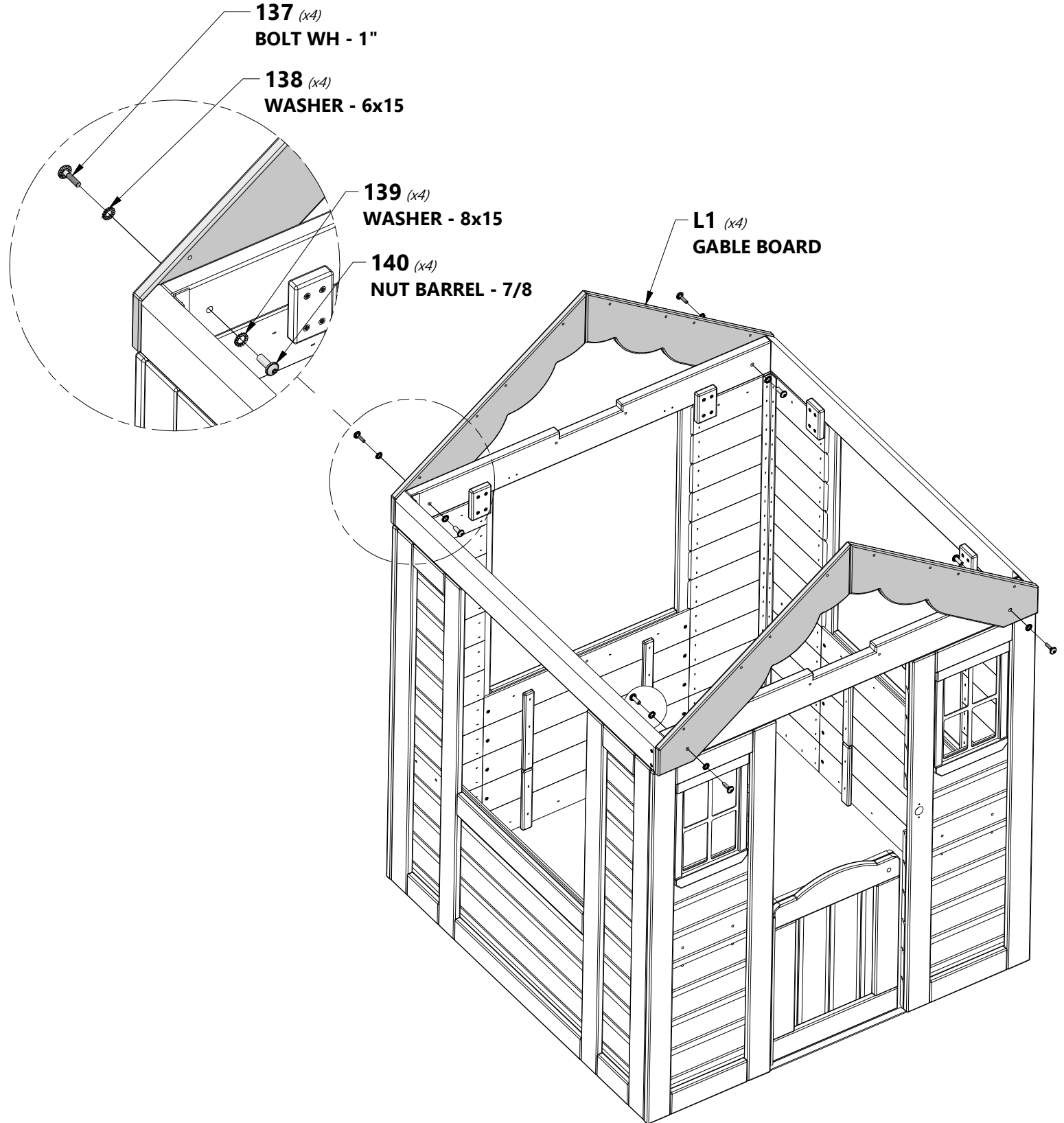

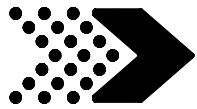

# STEP 10

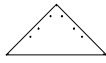

**K1 | TRIANGLE SUNBURST - W4L17069**  
(x2) | 5/8"x5 1/4"x10 3/8" (16x134x265)



**N5 | SUNBURST LEG - W4L17076**  
(x2) | 5/8"x2 3/8"x9 7/8" (16x60x250)



**N6 | SUNBURST LEG - W4L17077**  
(x4) | 5/8"x2 3/8"x8 1/4" (16x60x210)



**H100088 | SCREW PFH**  
(x20) | 8x1 1/8

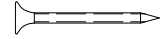

**H100086 | SCREW PFH**  
(x4) | 8x1 1/2

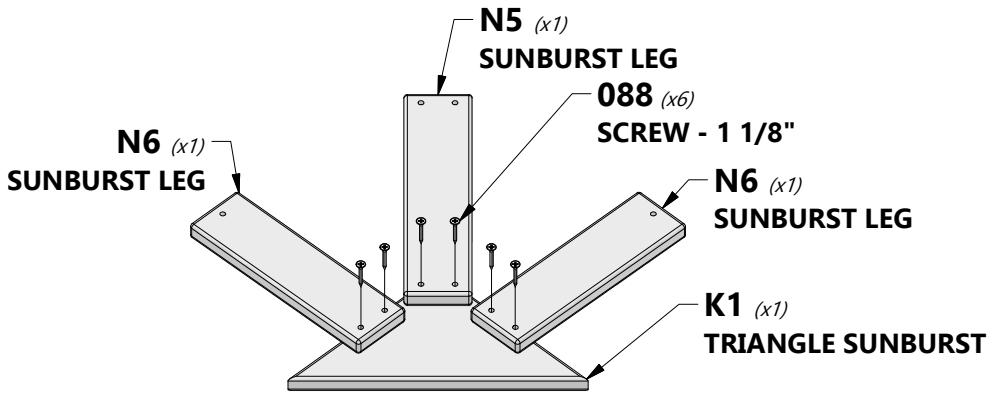

## SUNBURST ASSEMBLY

**⚠ NOTE:** REPEAT STEP TO COMPLETE TWO SUNBURST ASSEMBLIES.

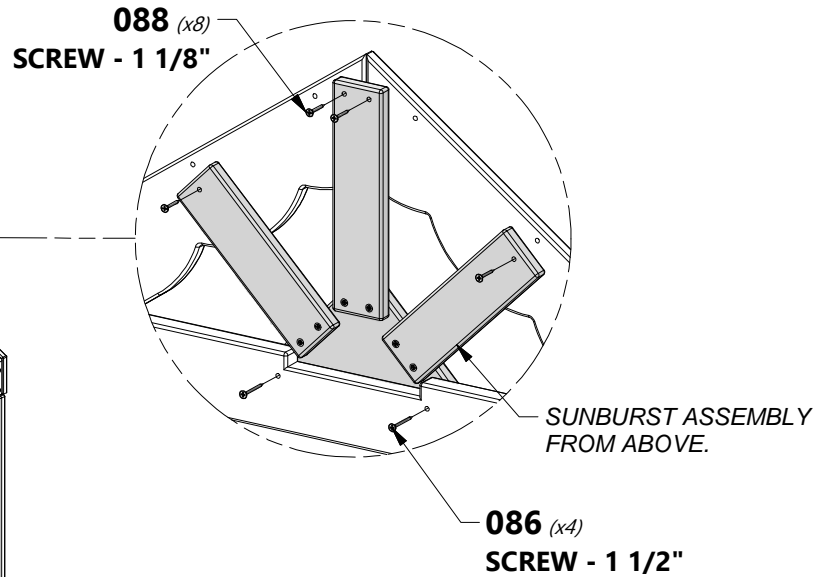
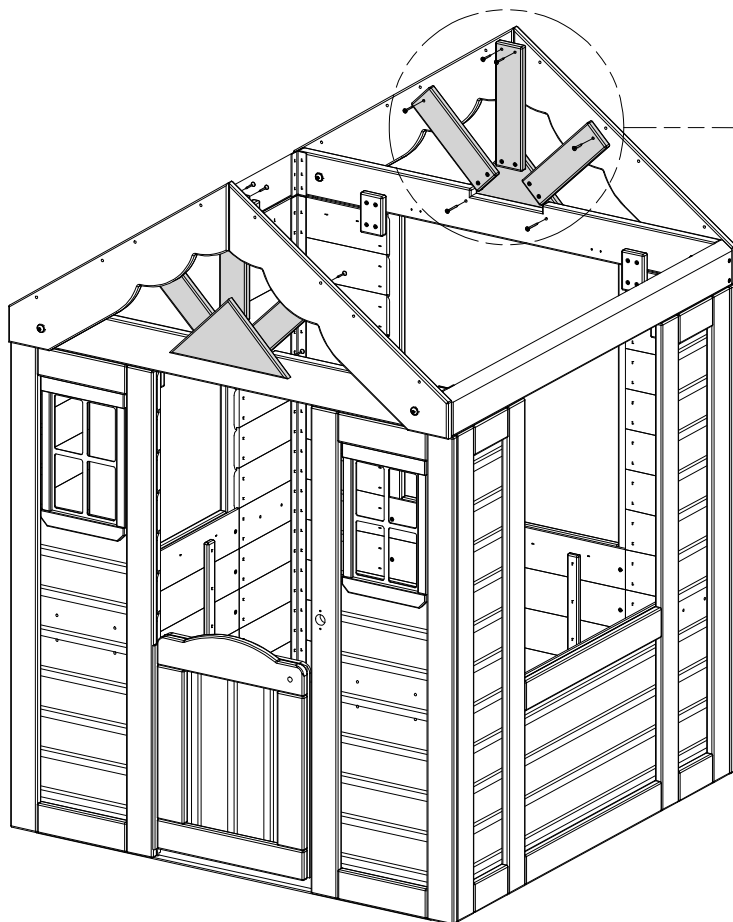

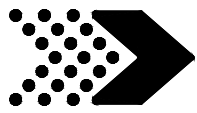

# STEP 11

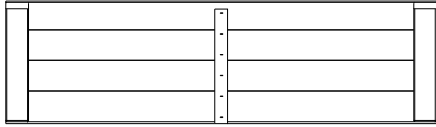

**RP2** | UPPER ROOF PANEL - W2A02983  
(x2) | 1 3/8"x12 3/4"x44 7/8" (35x324x1140)



**H100086** | SCREW PFH  
(x8) | 8x1 1/2

**REPEAT ON OPPOSITE END**

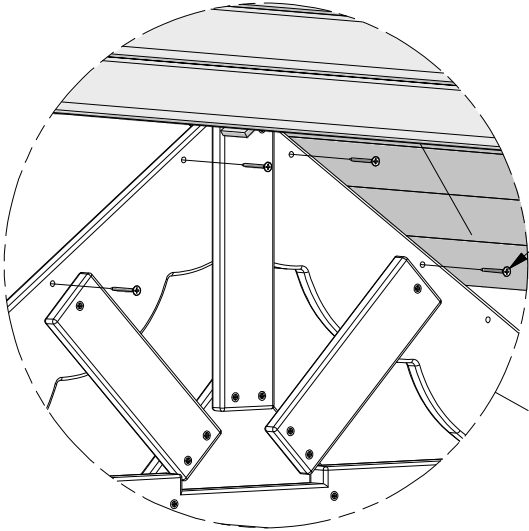

**086** (x4)  
SCREW - 1 1/2"

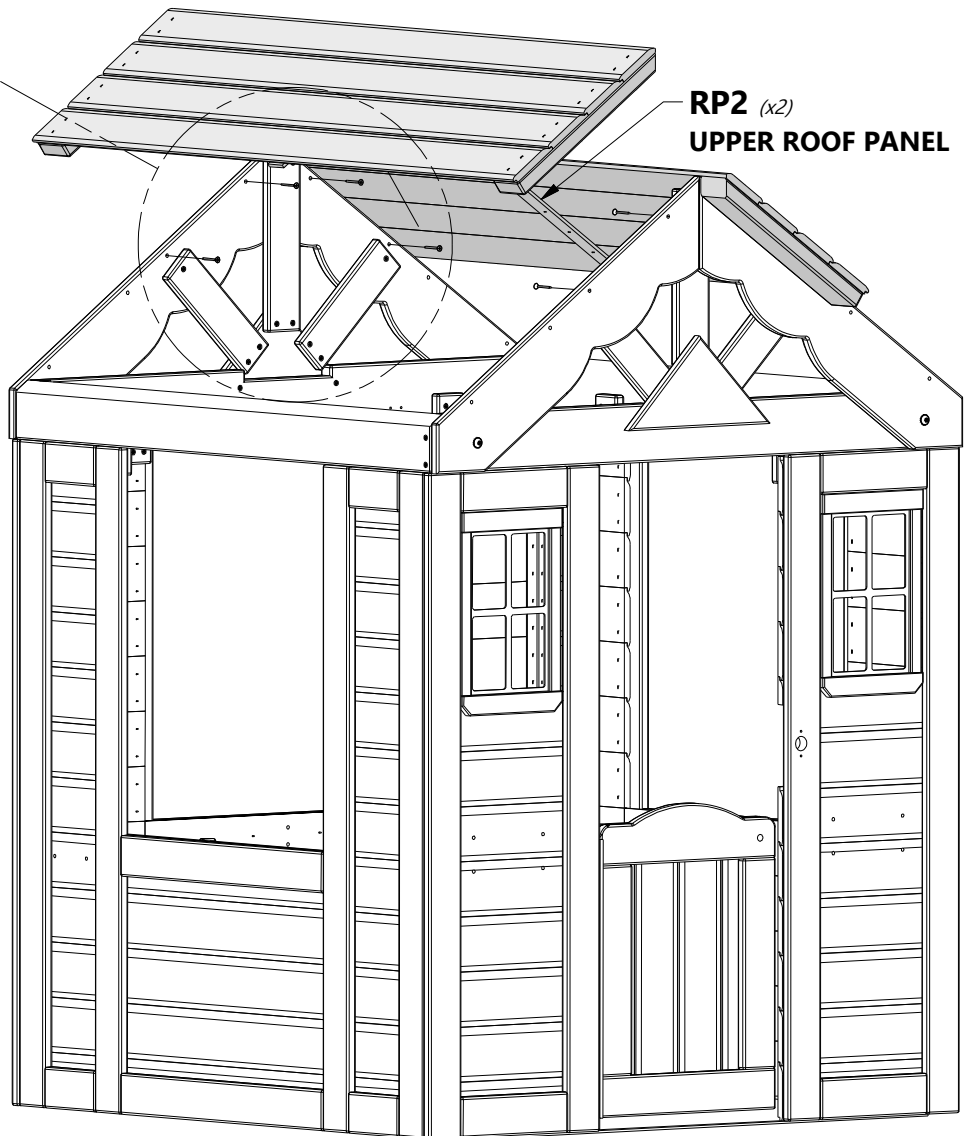

**RP2** (x2)  
UPPER ROOF PANEL

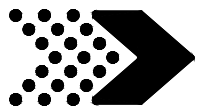

# STEP 12

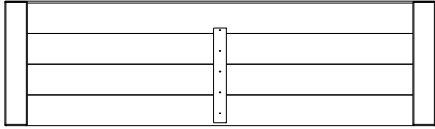

**RP1** | LOWER ROOF PANEL - W2A02982  
(x2) | 1 3/8"x13"x44 7/8" (35x329x1140)



**H100086** | SCREW PFH  
(x8) | 8x1 1/2

**REPEAT ON OPPOSITE END**

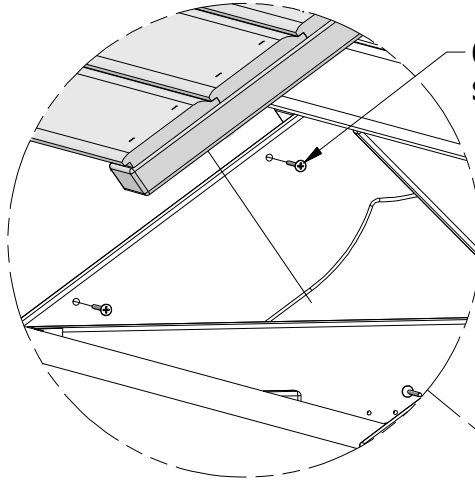

**086** (x4)  
**SCREW - 1 1/2"**

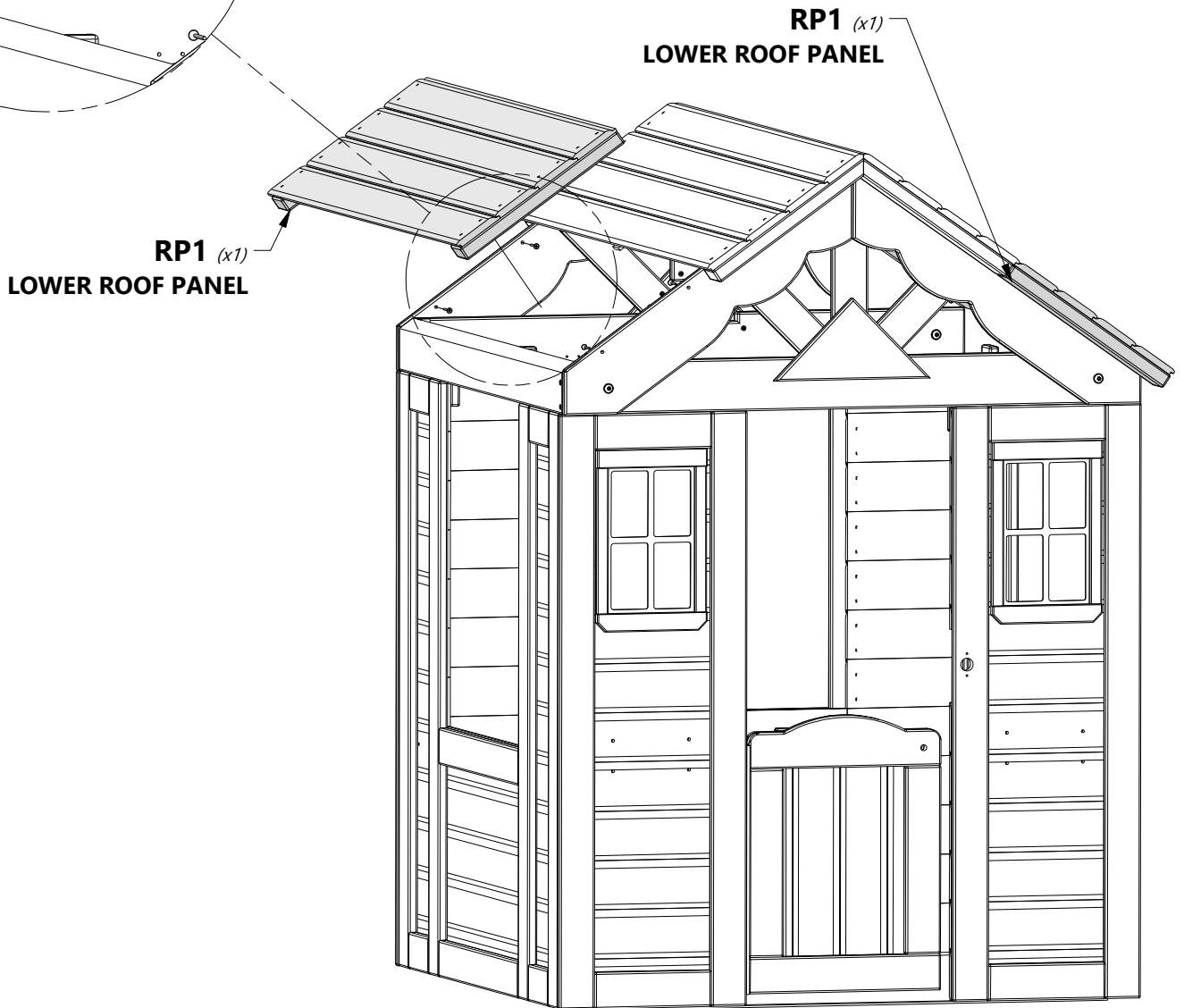

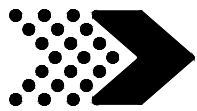

# STEP 13

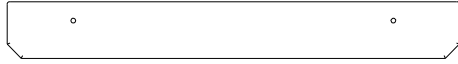

**N1** | SIDE WINDOW SHELF - W4L17072  
(x1) | 5/8"x2 3/8"x18 7/8" (16x60x479)



**H100087** | SCREW PFH  
(x2) | 8x1 1/4

## INSIDE VIEW

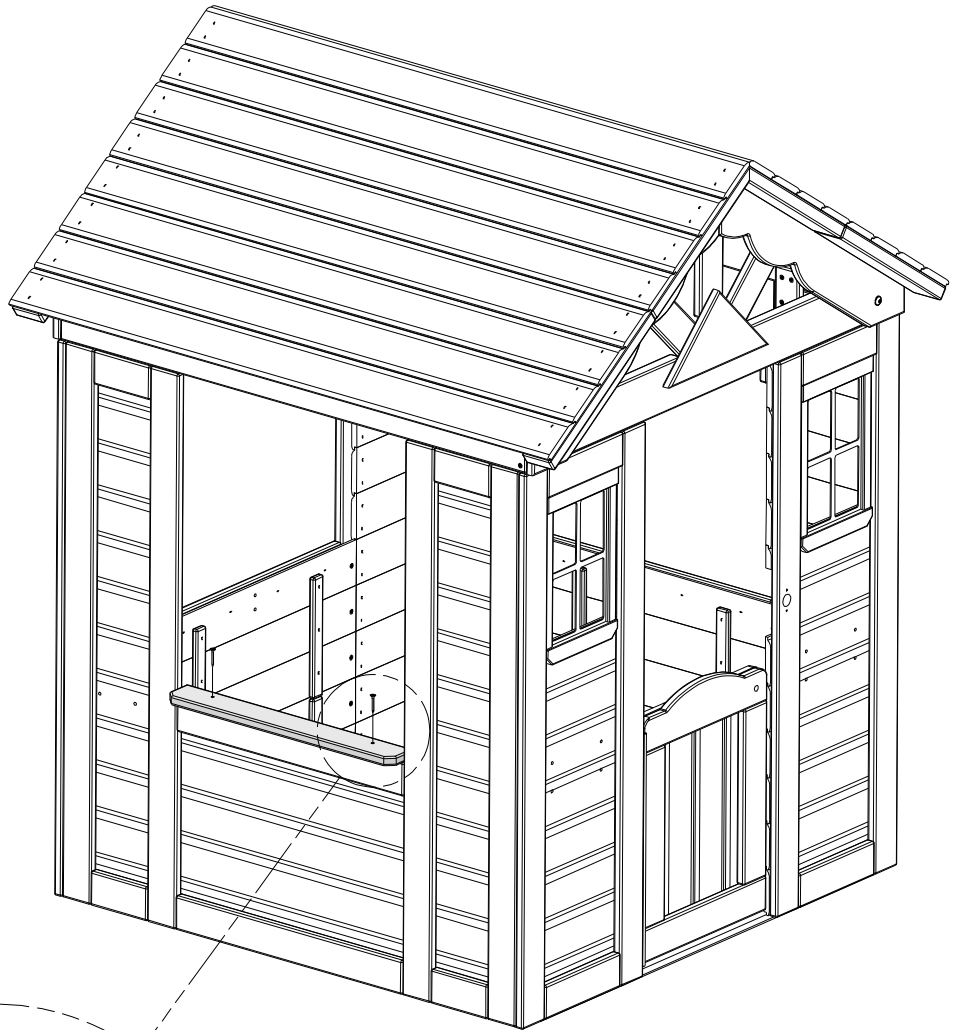
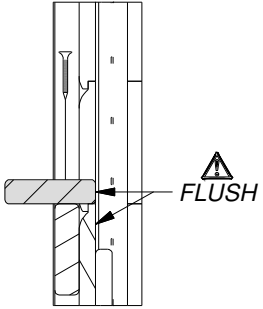

**087** (x2)  
SCREW - 1-1/4"

**N1** (x1)  
SIDE WINDOW SHELF

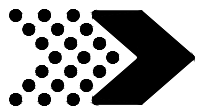

# STEP 14



**N2** | REAR WINDOW SHELF - W4L17073  
(x1) | 5/8"x2 3/8"x19 1/8" (16x60x485)



**H100087** | SCREW PFH  
(x2) | 8x1 1/4

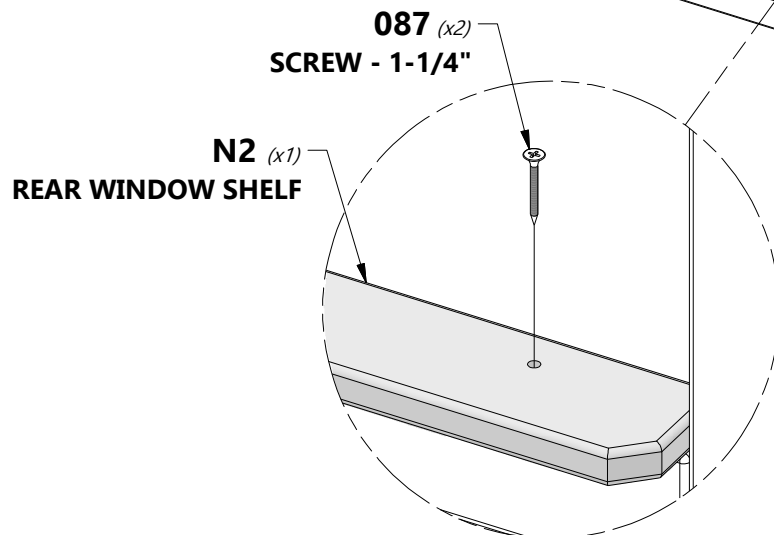
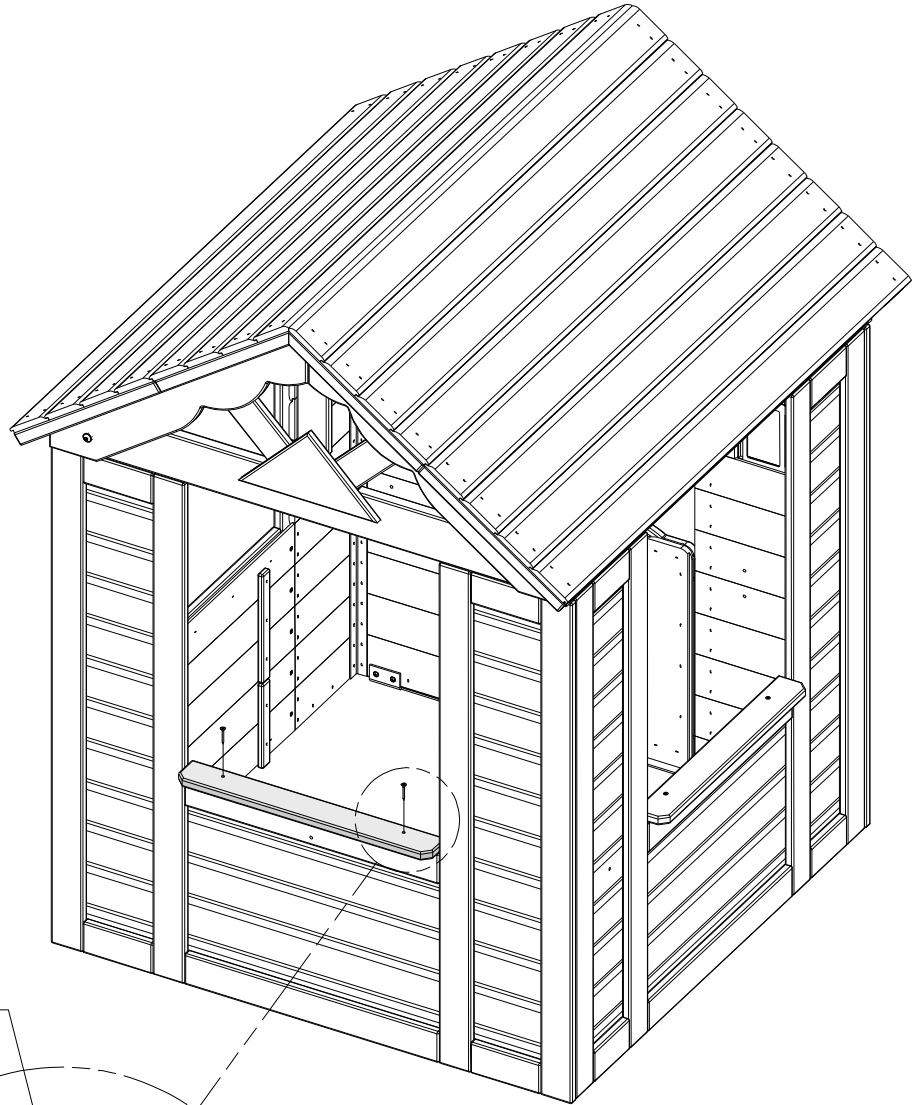
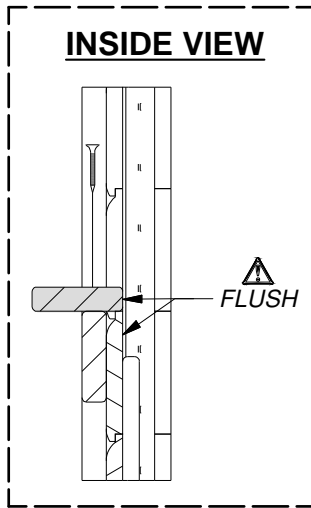



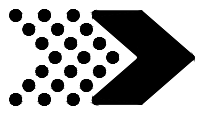

# STEP 15



**N1** | SIDE WINDOW SHELF - W4L17072  
(x1) | 5/8"x2 3/8"x18 7/8" (16x60x479)



**H100087** | SCREW PFH  
(x2) | 8x1 1/4

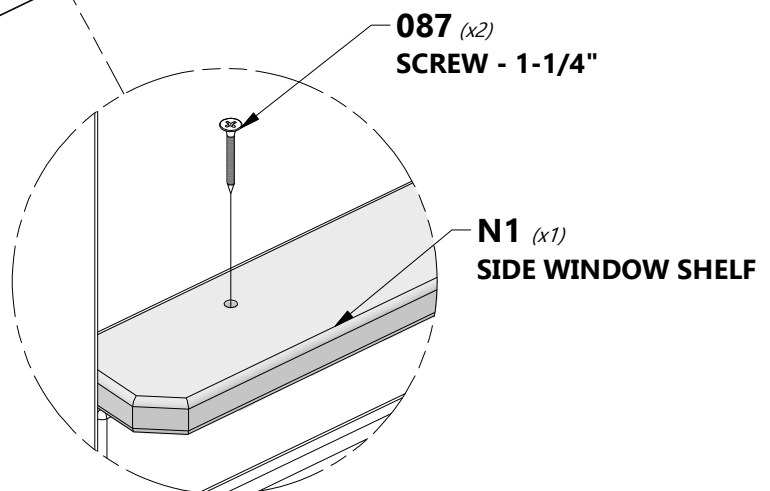
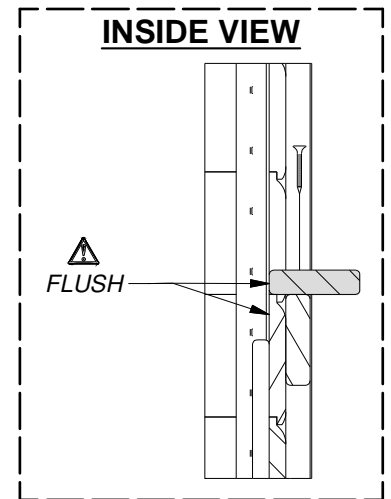
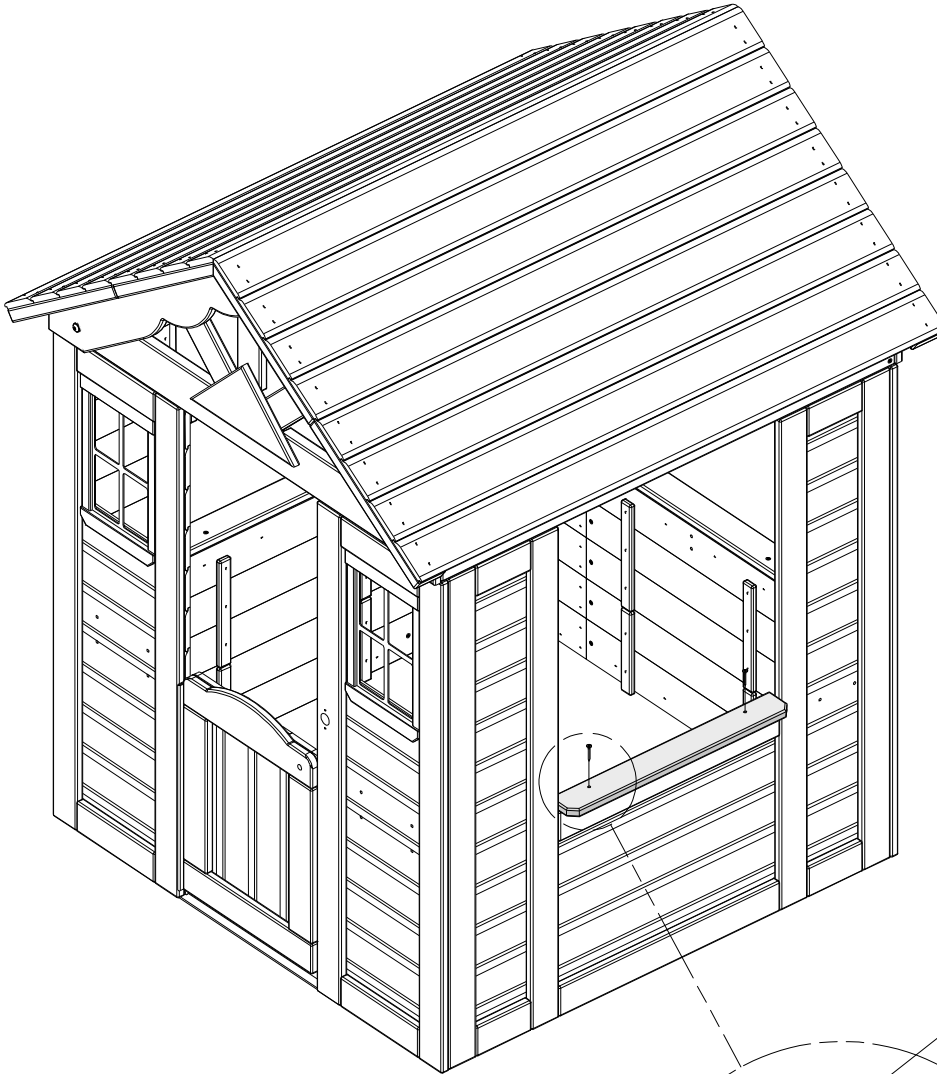

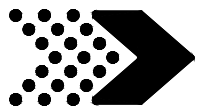

# STEP 16

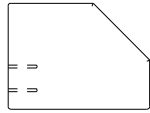

**D1** | COUNTER TOP SUPPORT - W4L17067  
(x1) | 1 3/8"x4 3/8"x5 7/8" (36x112x150)

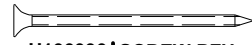

**H100090** | SCREW PFH  
(x2) | 8x2 1/2"

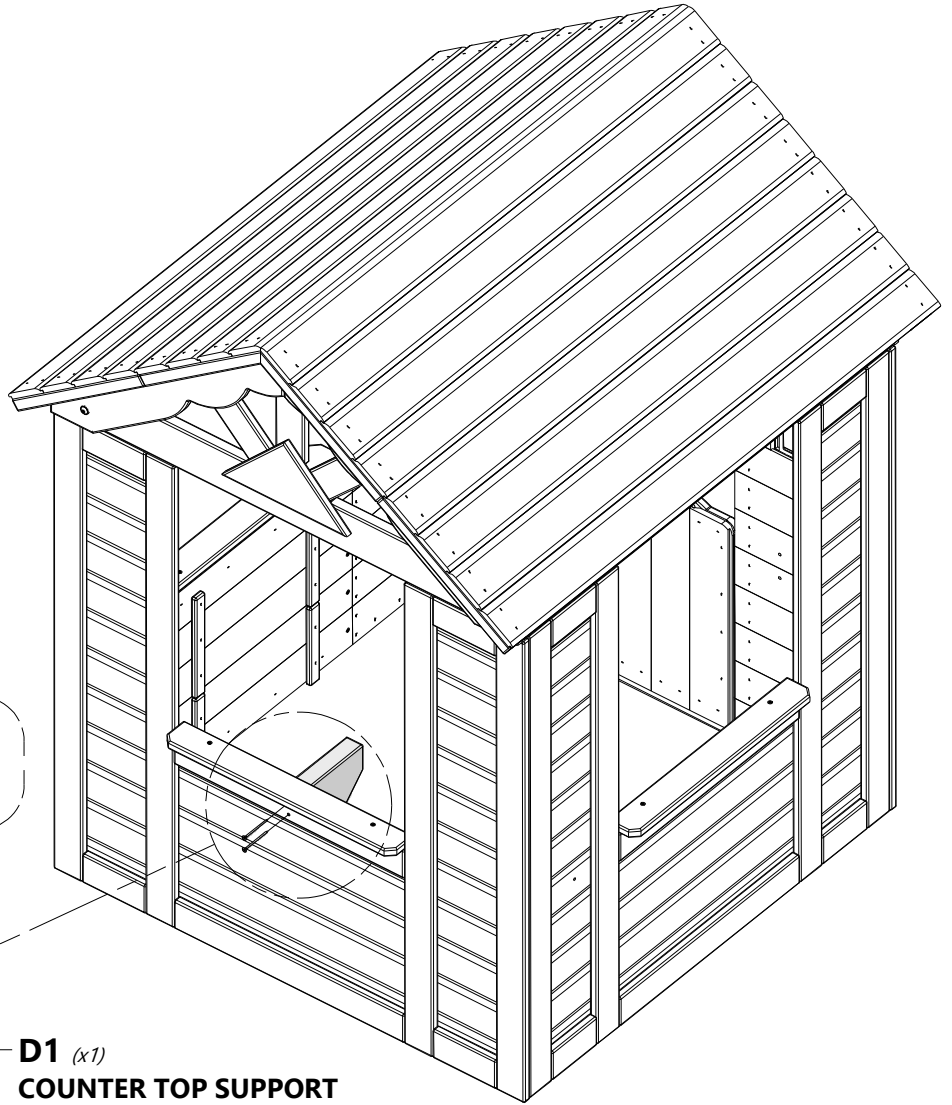

**NOTE:**  
ALIGN PILOT HOLES IN D1 AND ASSEMBLE.

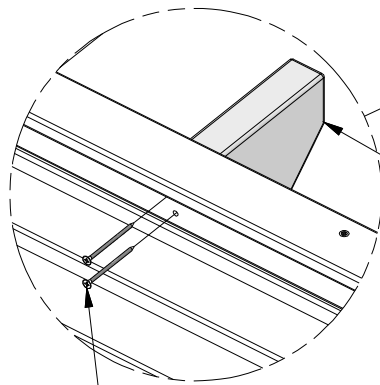

**090** (x2)  
SCREW - 2 1/2"

**D1** (x1)  
COUNTER TOP SUPPORT

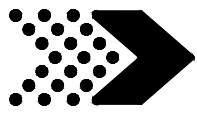

# STEP 17



**J1 | COUNTER TOP SUPPORT - W4L17068**  
(x2) | 1"x2 3/8"x5 7/8" (24x60x150)



**H100087 | SCREW PFH**  
(x4) | 8x1 1/4

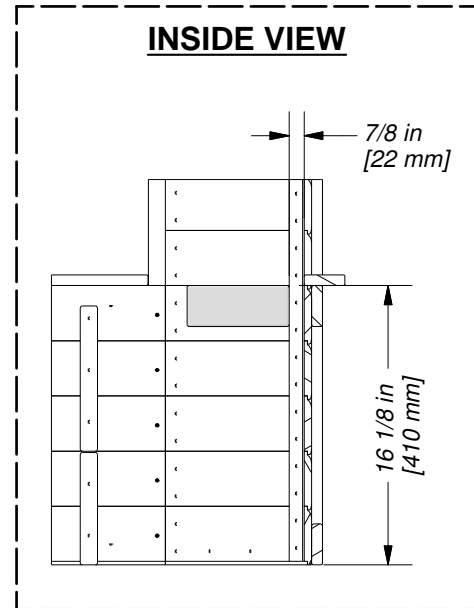
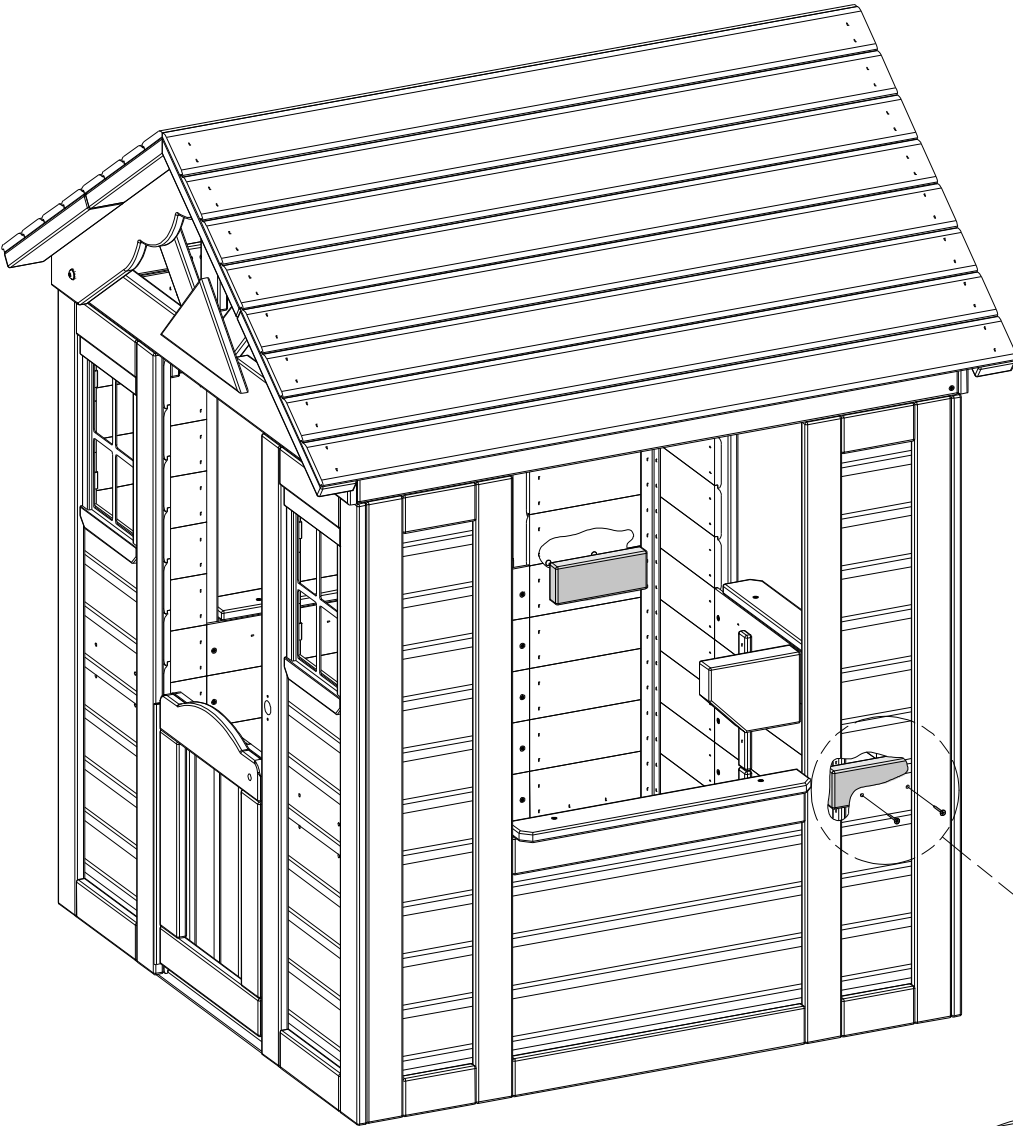

**J1 (x1)**  
**COUNTER TOP SUPPORT**

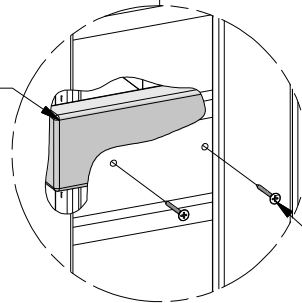

**087 (x2)**  
**SCREW - 1-1/4"**

**REPEAT ON OPPOSITE WALL**

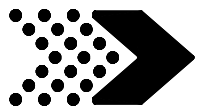

# STEP 18

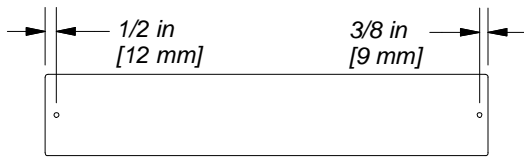

**M1** | COUNTER TOP - W4L17071  
(x4) | 5/8"x3 3/8"x18 1/2" (16x86x469)



**H100087** | SCREW PFH  
(x8) | 8x1 1/4

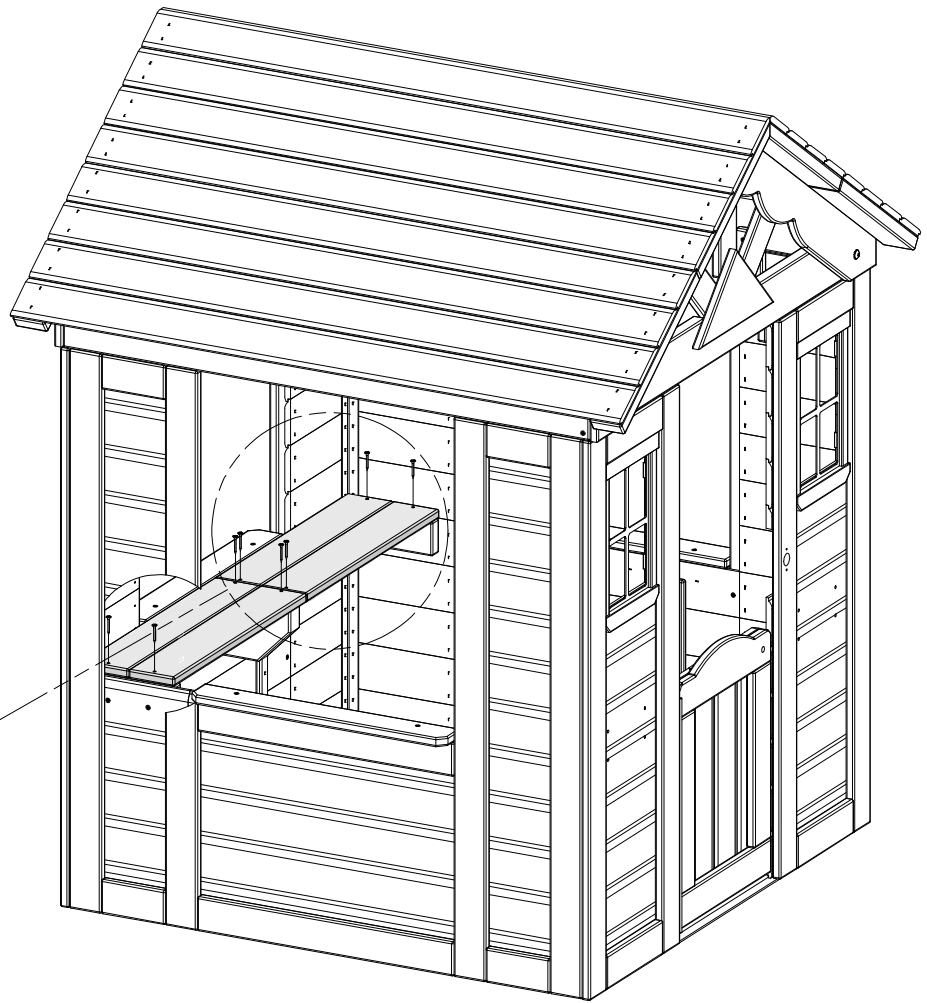
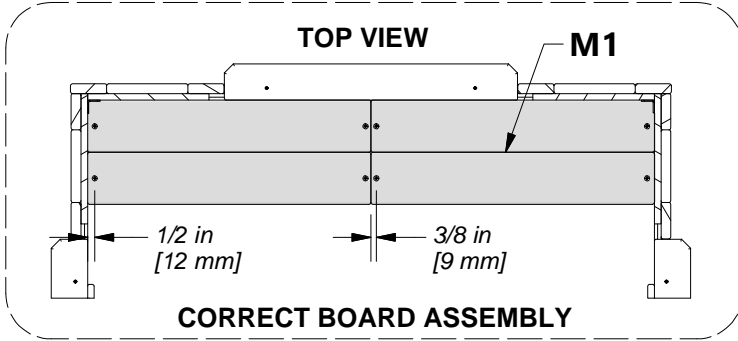

**087** (x8)  
SCREW - 1-1/4"

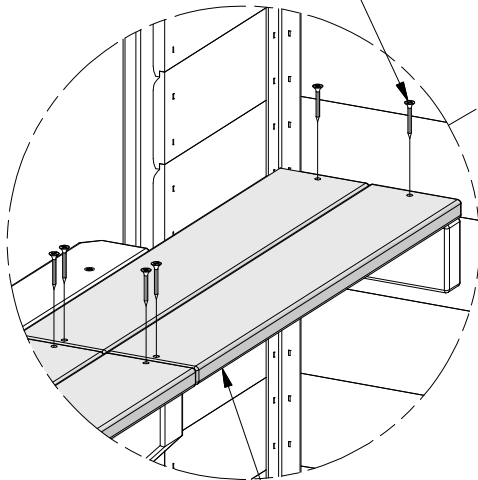

**M1** (x4)  
COUNTER TOP

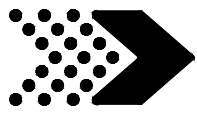

# STEP 19

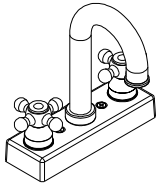

**A6P00024** | FAUCET KIT  
(x1)



**H100086** | SCREW PFH  
(x2) | 8x1 1/2

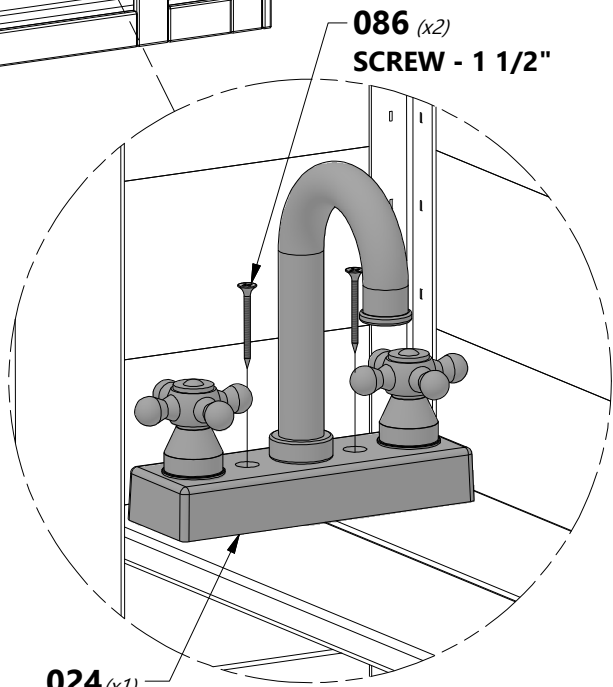
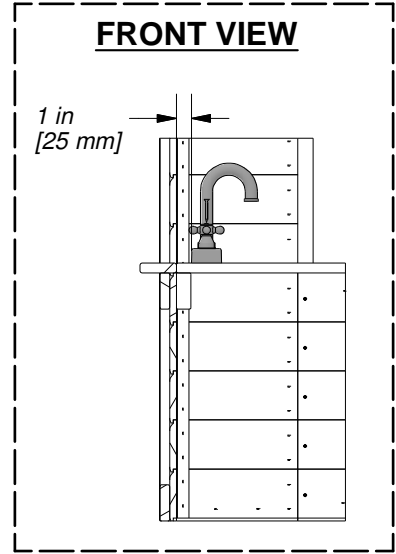
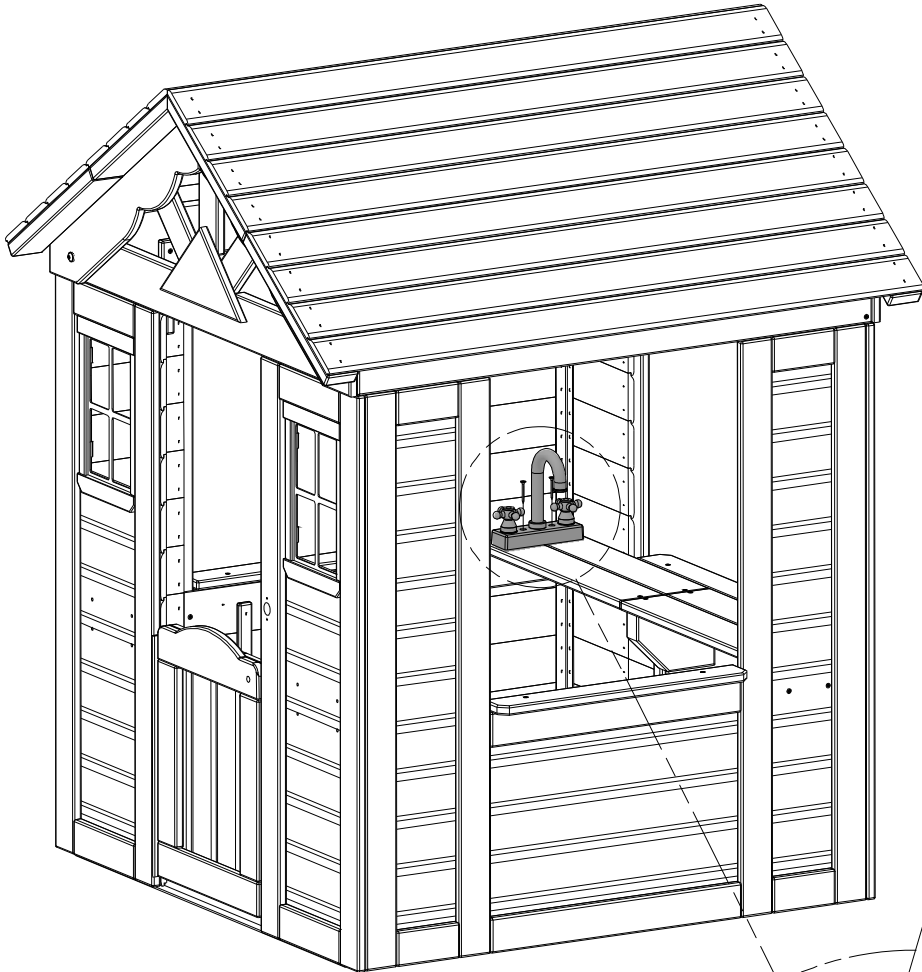

**086** (x2)  
SCREW - 1 1/2"

**024** (x1)  
FAUCET KIT

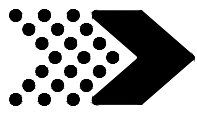

# STEP 20

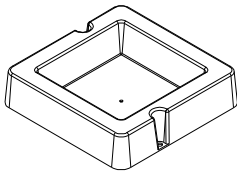

**A6P00032** | SURFACE MOUNT BASIN  
*(x1)*



**H100128** | SCREW PWH  
*(x2)* 8x5/8

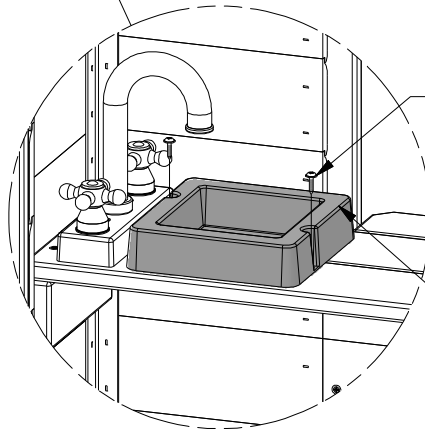
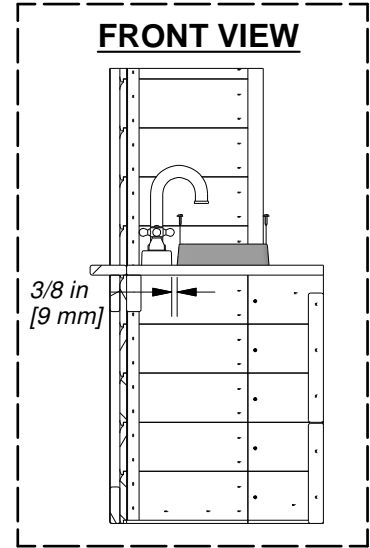
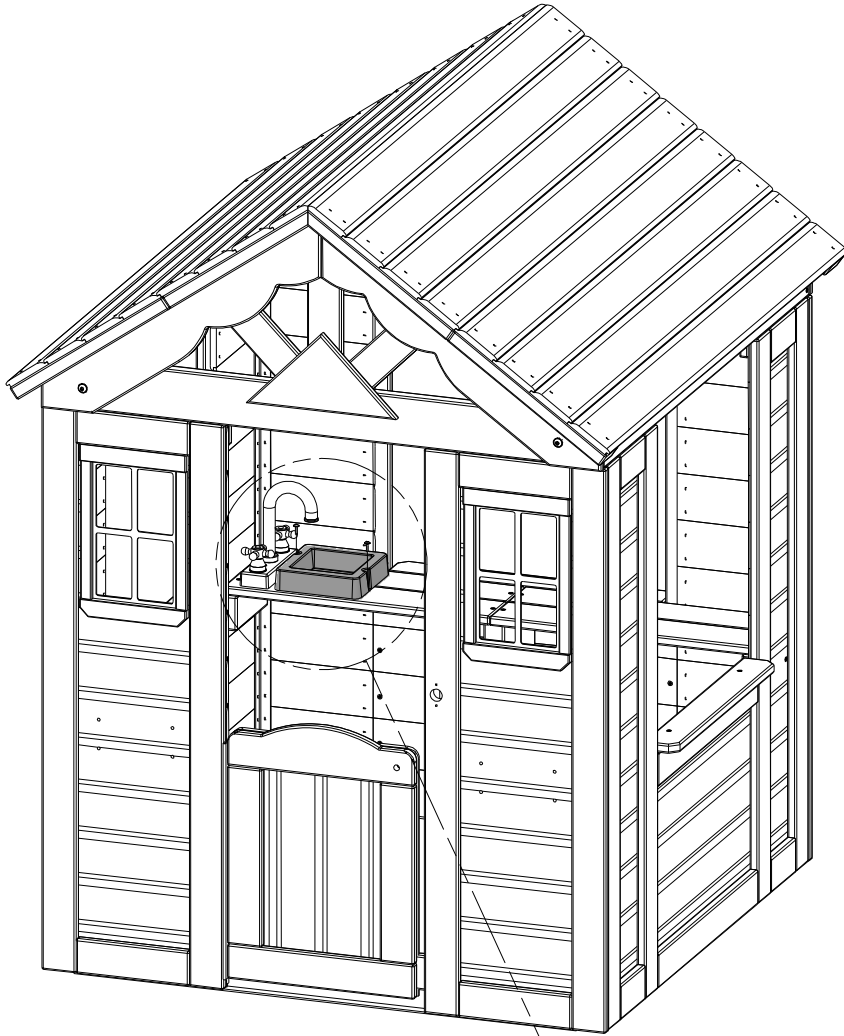

**128** *(x2)*  
SCREW - 5/8

**032** *(x1)*  
SURFACE MOUNT BASIN

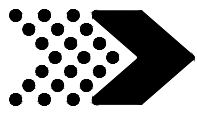

# STEP 21

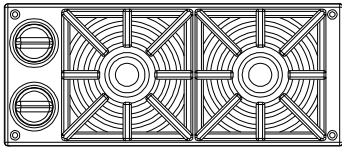

**A6P00025** | STOVE KIT  
(x1)



**H100088** | SCREW PFH  
(x4) | 8x1 1/8

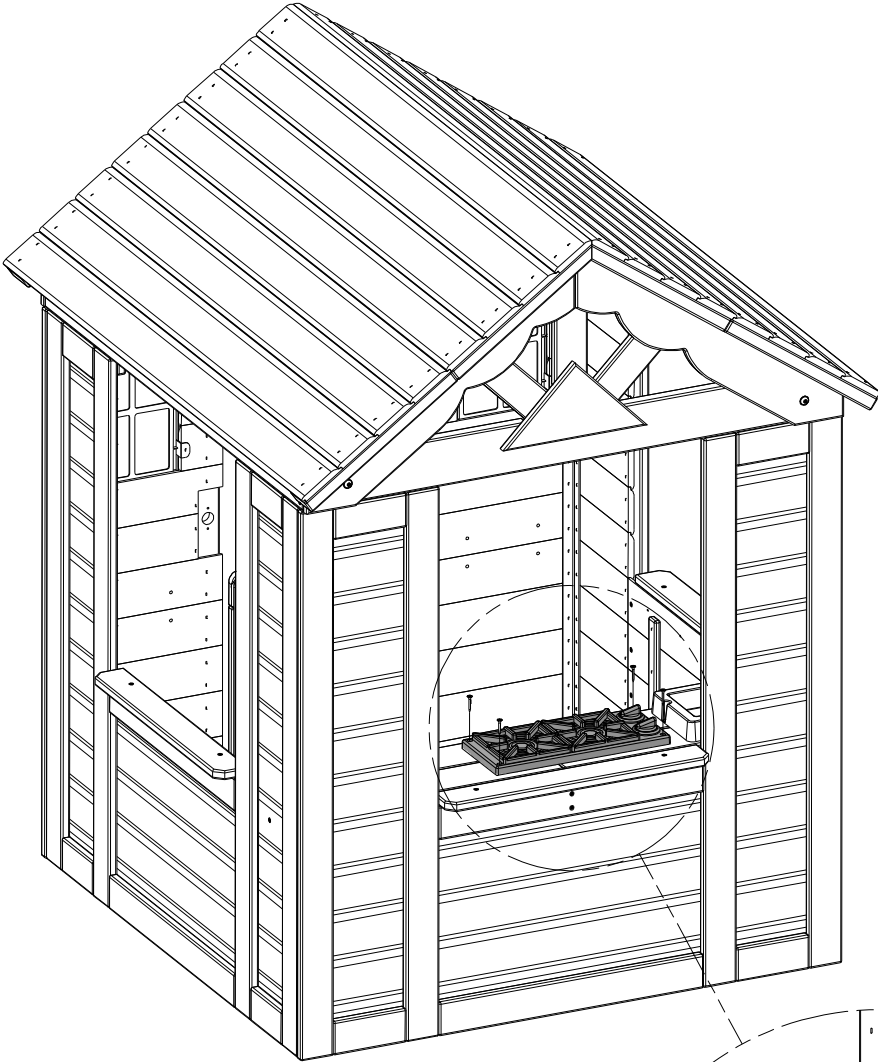

**088** (x4)  
SCREW - 1 1/8"

**025** (x1)  
STOVE KIT

1 1/8 in  
[29 mm]

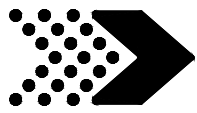

# STEP 22

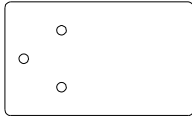

**N3** | DOOR STOP - W4L17074  
(x1) | 5/8"x2 3/8"x3 7/8" (16x60x100)



**H100087** | SCREW PFH  
(x3) | 8x1 1/4

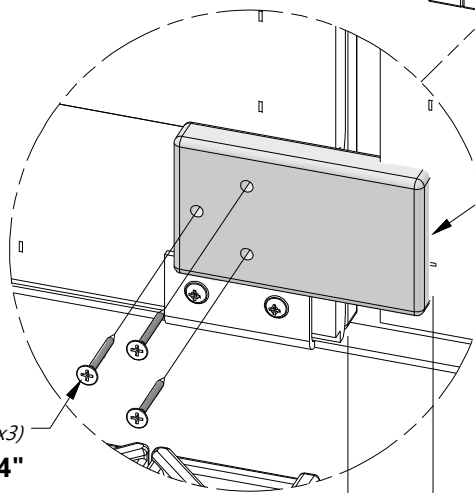
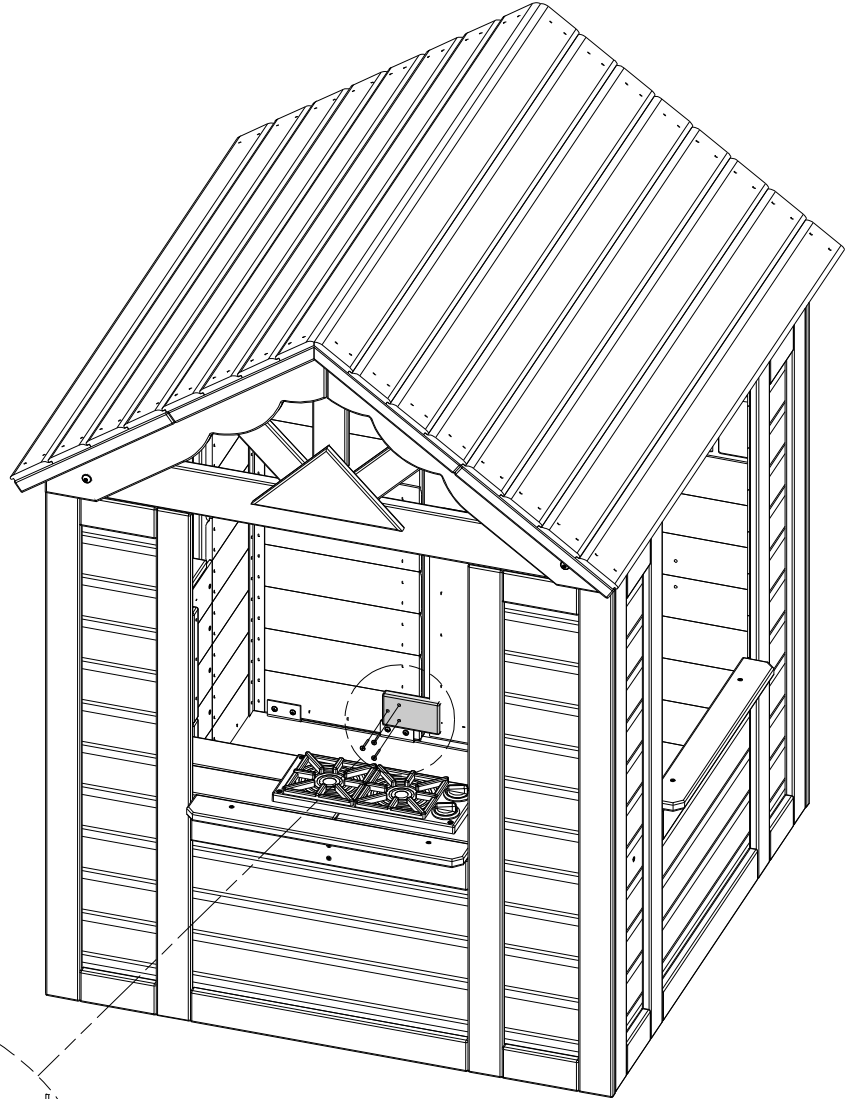

**087** (x3)  
SCREW - 1-1/4"

**N3** (x1)  
DOOR STOP

  
1 5/8 in  
[40 mm]



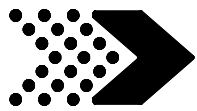

# STEP 23

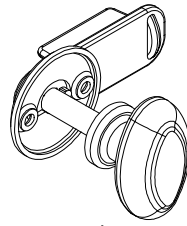

**A6P00020**  
(x1) | **KNOB KIT**

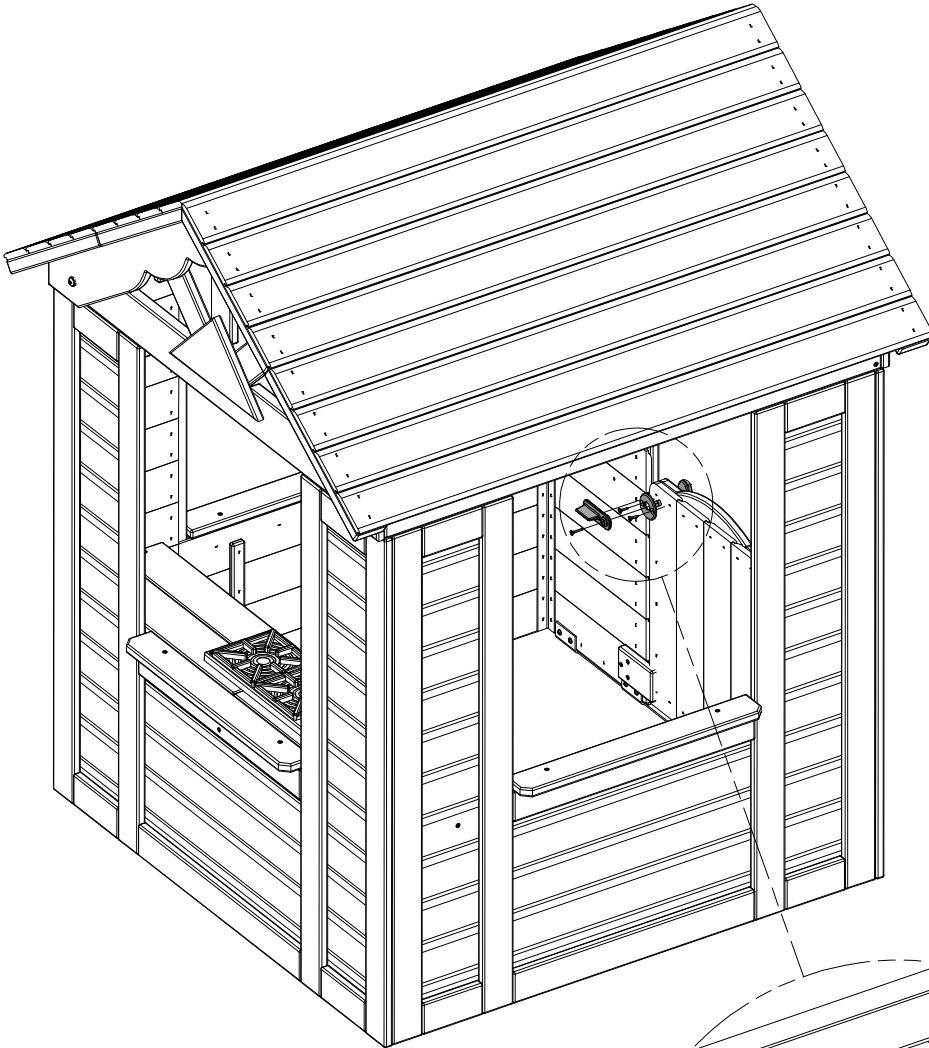

**TIP:**  
WHEN DOOR LATCH IS IN THE UNLOCKED POSITION IT SHOULD FACE IN THE UPWARD DIRECTION.



**NOTE:**  
ALIGN FACE PLATE AS SHOWN BELOW THEN PRE-DRILL PILOT HOLES USING AN 1/8" [3 mm] DRILL BIT, 1/2" [12 mm] DEEP FOR HARDWARE.



**NOTE ARCH IN FACE PLATE FACES UP.**

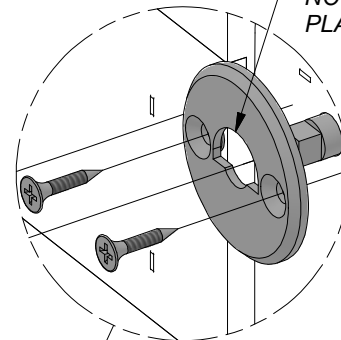

**LATCH**

**SCREW - 1" (x1)**  
**INCLUDED IN KNOB KIT**

**SCREW - 3/4" (x2)**  
**INCLUDED IN KNOB KIT**

**020 (x1)**  
**LATCHING KNOB KIT**

**KNOB**

**FACE PLATE**

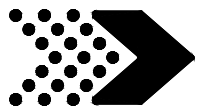

# STEP 24

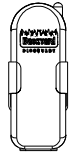

**A100132** | PHONE KIT  
(x1)



**H100124** | SCREW PFH  
(x2) 8 x 1/2

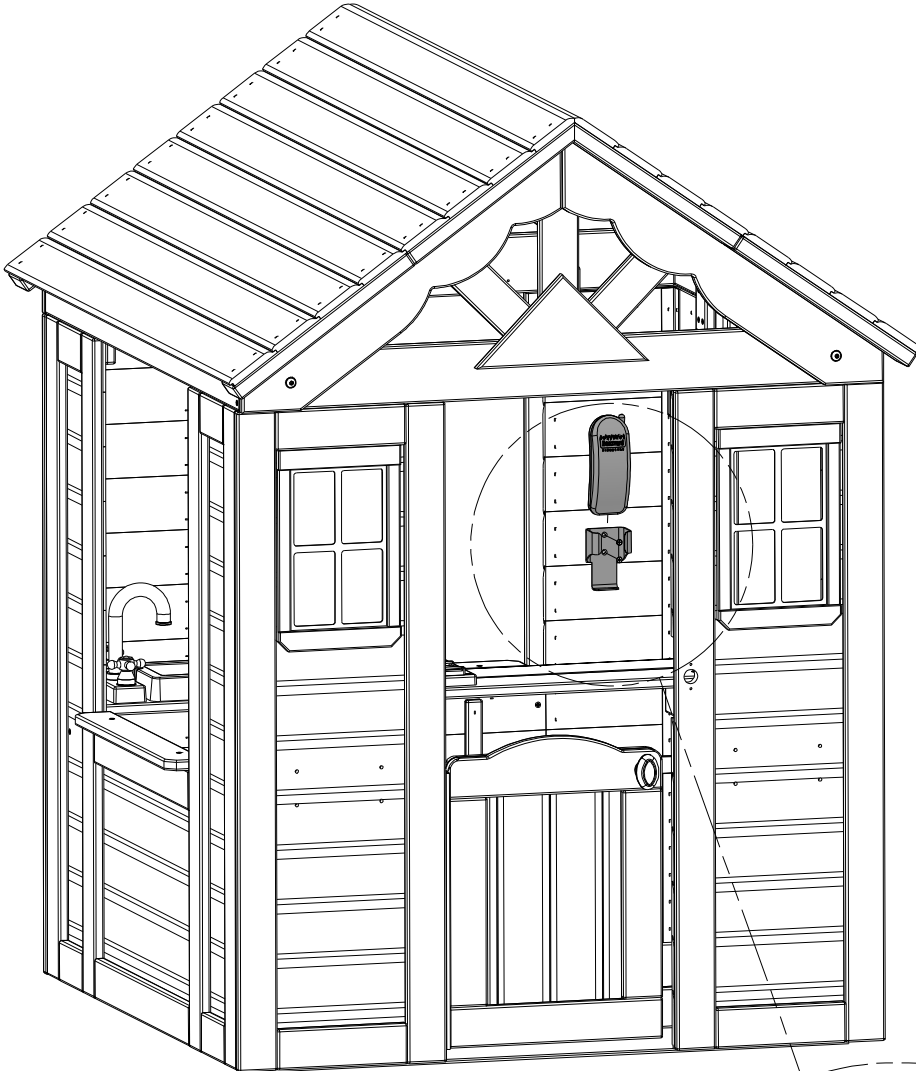

**TIP:**

CENTER PHONE AND MOUNT  
USING THE DIMENSION BELOW  
OR YOUR DESIRED LOCATION.

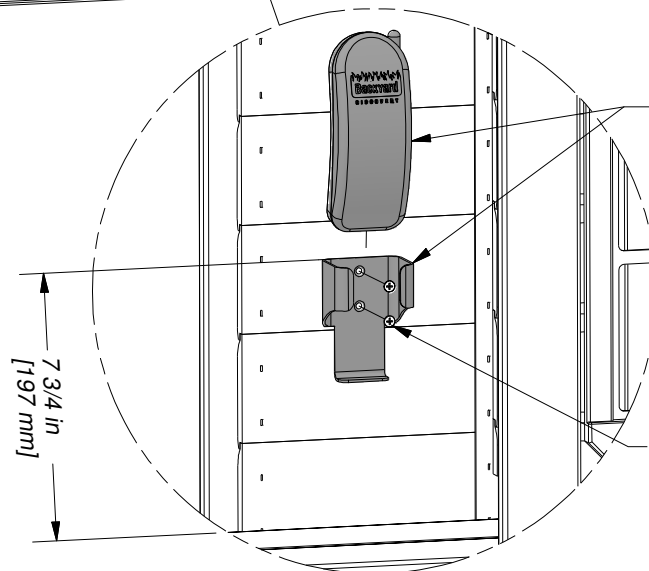

**132** (x1)  
PHONE KIT

**124** (x2)  
SCREW PFH 8x1/2

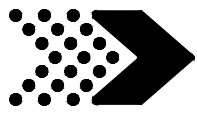

# STEP 25

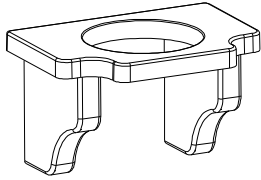

**A6P00387**  
(x2) | **FLOWER POT HOLDER - BLK**



**H100085** | **SCREW PFH**  
(x8) | **8x1**

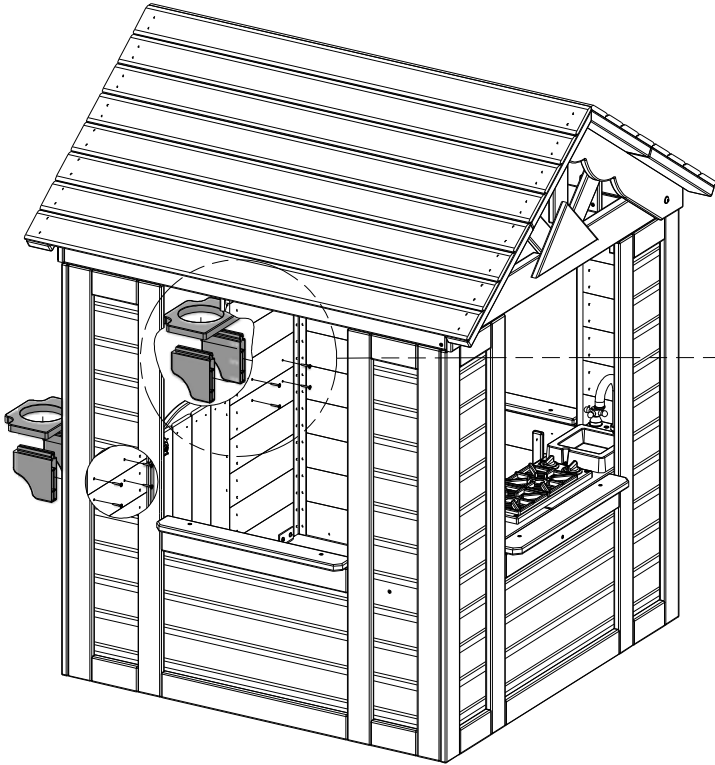

**REPEAT ON OPPOSITE SIDE**

**387** (x1)  
**FLOWER POT HOLDER - BLK**

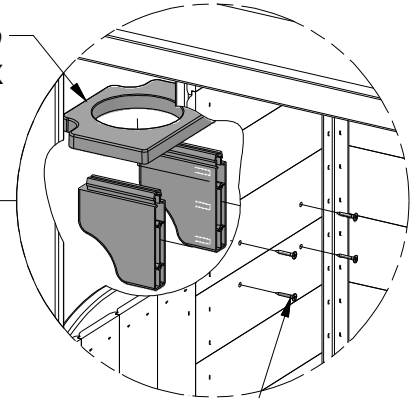

**085** (x4)  
**SCREW - 1"**

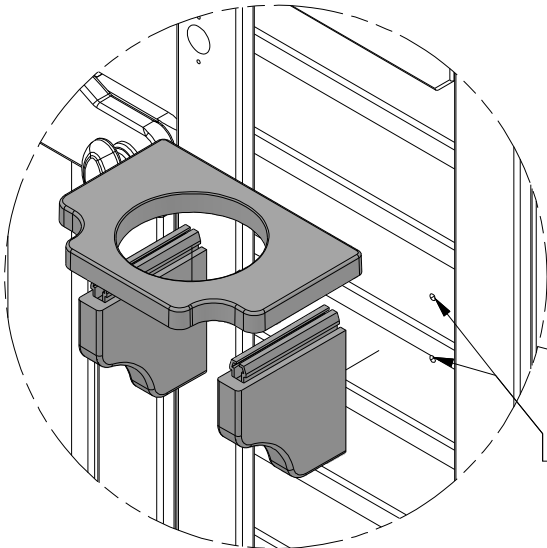

 **NOTE HOLE LOCATIONS**

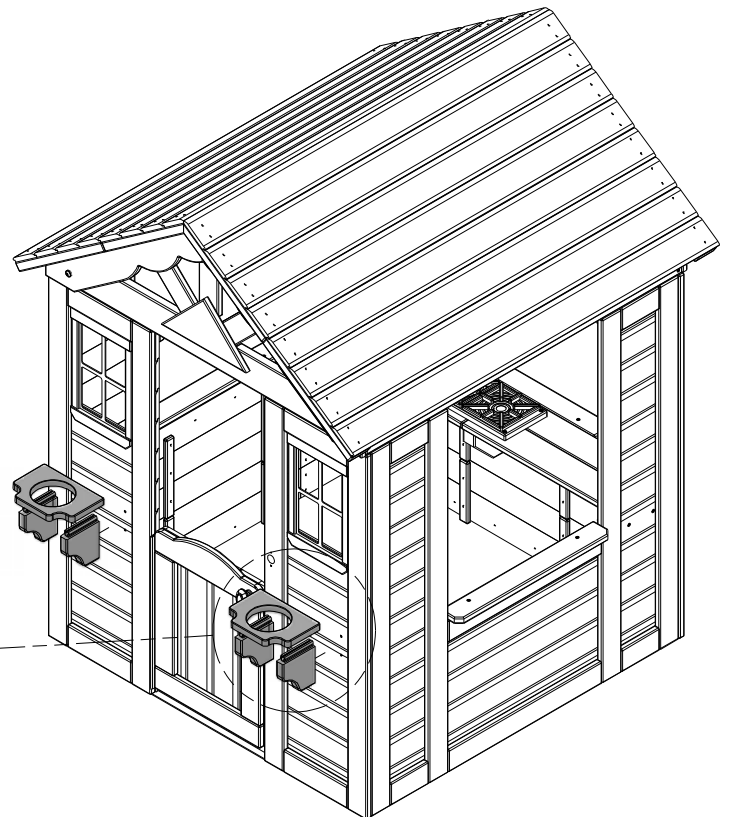

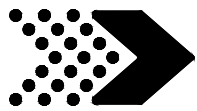

# STEP 26



**A4M00528** | BYD ID TAG (MEDIUM) AGES 2 TO 10  
*(x1)*



**H100361** | SCREW PWH  
*(x2)* | 8x7/16

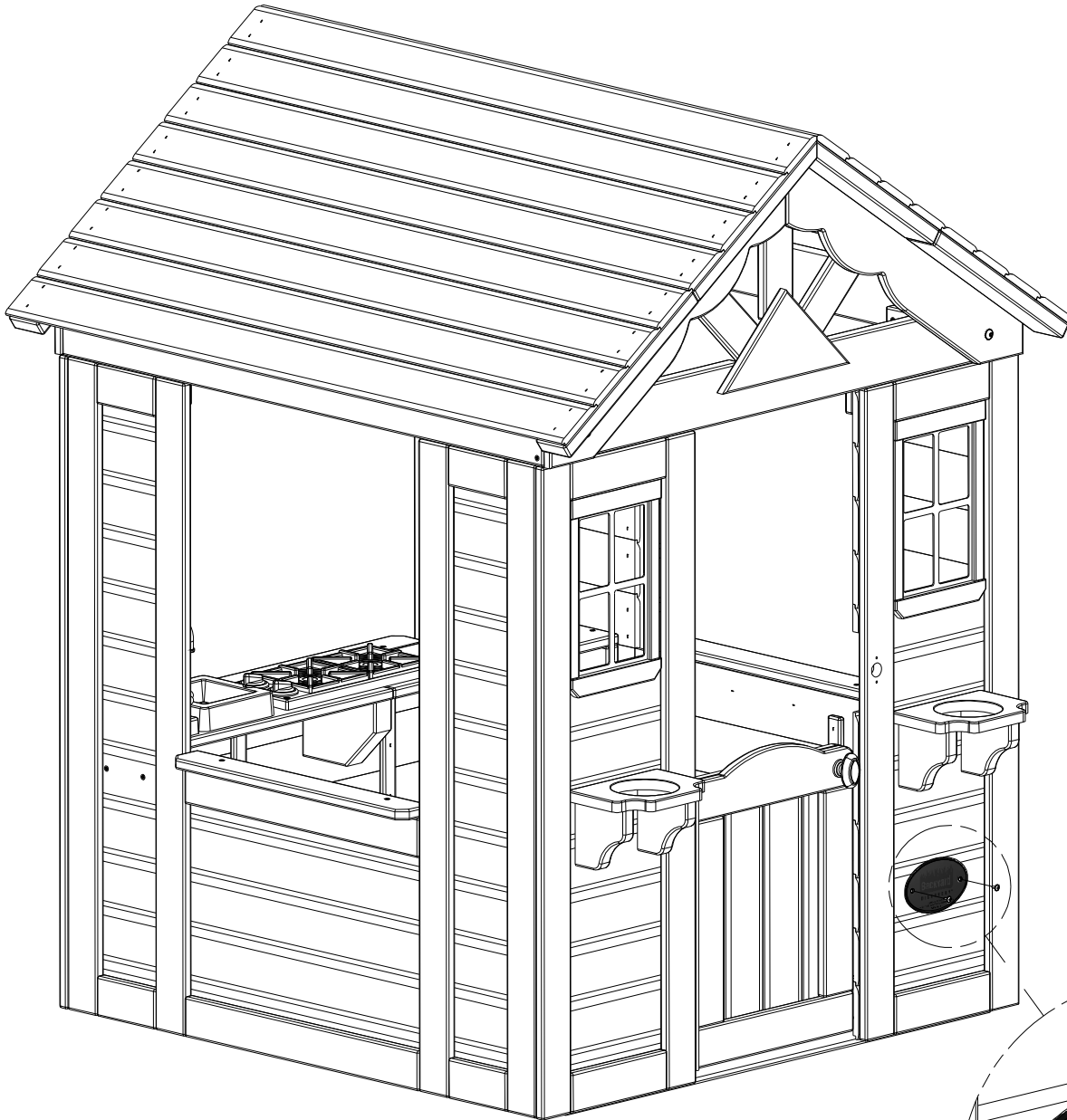

**528** *(x1)*  
BYD ID TAG (MEDIUM) AGES 2 TO 10

**361** *(x2)*  
SCREW - 7/16"

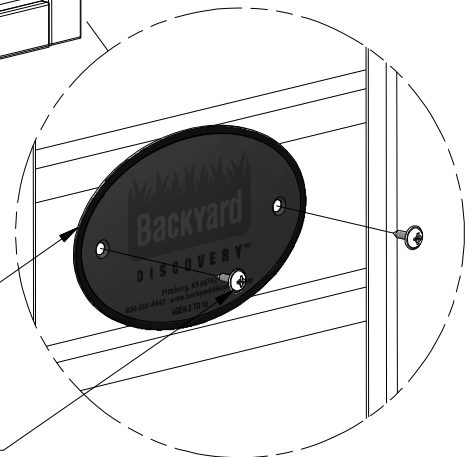

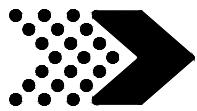

# STEP 27

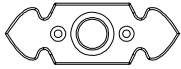

**A6P00290** | DOOR BELL PLATE  
*(x1)*

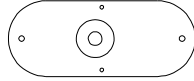

**A100174** | DOOR BELL  
*(x1)*



**H100537** | SCREW PFH SD  
*(x2)* | 8x1



**H100624** | SCREW PFH BLK  
*(x2)* | 6x5/8

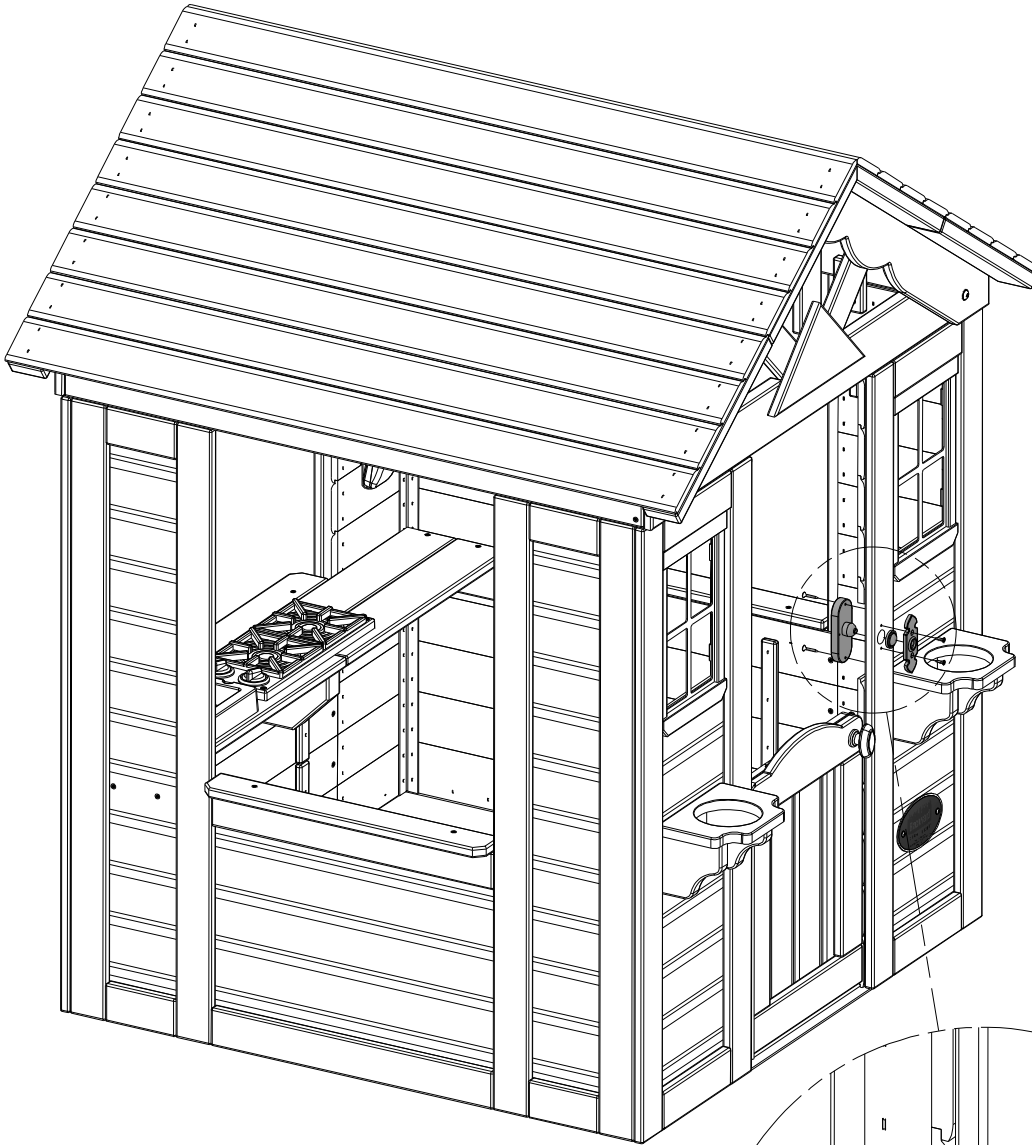

**174** *(x1)*  
DOOR BELL

**537** *(x2)*  
SCREW - 1"

 NOTE PILOT HOLES.

**290** *(x1)*  
DOOR BELL PLATE &  
RUBBER BUTTON

**624** *(x2)*  
SCREW - 5/8"



# STEP 28

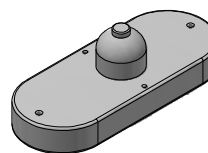

**A100174** | DOOR BELL  
*(x1)*

FCC LABEL

**NOTE:**

- DO NOT MIX OLD AND NEW BATTERIES.
- DO NOT MIX ALKALINE, STANDARD (CARBON-ZINC), OR RECHARGEABLE (NI-CAD, NI-MH, ETC.) BATTERIES.
- NON-RECHARGEABLE BATTERIES ARE NOT TO BE RECHARGED.
- ONLY BATTERIES OF THE SAME OR EQUIVALENT TYPE AS RECOMMENDED ARE TO BE USED.
- BATTERIES ARE TO BE INSERTED WITH THE CORRECT POLARITY.
- EXHAUSTED BATTERIES ARE TO BE REMOVED FROM THE TOY OR IF THE TOY IS TO BE LEFT UNUSED FOR A LONG TIME.
- THE SUPPLY TERMINALS ARE NOT TO BE SHORT-CIRCUITED.



**NOTE:**

THIS DEVICE COMPLIES WITH PART 15 OF THE FCC RULES. OPERATION IS SUBJECT TO THE FOLLOWING TWO CONDITIONS: (1) THIS DEVICE MAY NOT CAUSE HARMFUL INTERFERENCE, (2) THIS DEVICE MUST ACCEPT ANY INTERFERENCE RECEIVED, INCLUDING INTERFERENCE THAT MAY CAUSE UNDESIRABLE OPERATION.

**NOTE:**

USING A SCREW DRIVER, REPLACE BATTERIES BY REMOVING SCREW IN BATTERY COVER, REMOVING BATTERY COVER AND FOLLOWING DIRECTIONS FOR BATTERY REPLACEMENT LOCATED ON THE BATTERY COVER.

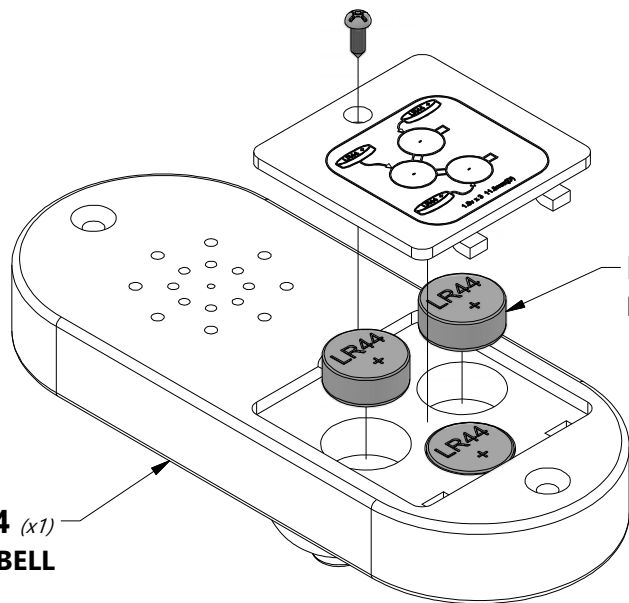

**LR44** *(x3)*  
**BATTERY (INCLUDED)**

**174** *(x1)*  
**DOOR BELL**



**WARNING:**

1. KEEP BATTERIES OUT OF THE REACH OF CHILDREN.
2. SWALLOWING MAY LEAD TO SERIOUS INJURY OR DEATH IN AS LITTLE AS 2 HOURS, DUE TO CHEMICAL BURNS AND POTENTIAL PERFORATION OF THE ESOPHAGUS.
3. IF YOU SUSPECT YOUR CHILD HAS SWALLOWED A BUTTON BATTERY, IMMEDIATELY SEEK URGENT MEDICAL ASSISTANCE.
4. EXAMINE DEVICES AND MAKE SURE THE BATTERY COMPARTMENT IS CORRECTLY SECURED, E.G. THAT THE SCREW OR OTHER MECHANICAL FASTENER IS TIGHTENED. DO NOT USE IF COMPARTMENT IS NOT SECURE.
5. DISPOSE OF USED BUTTON BATTERIES IMMEDIATELY AND SAFELY. FLAT BATTERIES CAN STILL BE DANGEROUS.
6. TELL OTHER OF THE RISK ASSOCIATED WITH BUTTON BATTERIES AND HOW TO KEEP THEIR CHILDREN SAFE.