



FABRIQUÉE PAR:
Backyard Discovery
3305 Airport Drive, Pittsburg, KS 66762
800-856-4445

Basepoint Business Centre: Rivermead Drive, Westlea, Swindon SN5 7EX Phone: 0800-118-2476
J.P. Coenstraat 7, The Bridge, The Hague, 2595 WP, Netherlands Phone: 0800-567-8990

CABLE CARAWAY – BLANQUE

MAISONNETTE POUR LES ENFANTS

MODÈLE N° 2303041

Veillez garder le manuel parce qu'il contient des informations importantes.



ATTENTION
ASSEMBLAGE PAR ADULTE REQUISE
Ne convient pas aux enfants de moins de 36 mois en raison de petites pièces. **UNIQUEMENT POUR L'USAGE RÉSIDENTIELLE.**
CONÇUE POUR L'USAGE EXTÉRIEURE.

CAN ICES-003 (B)/NMB-003(B)



Veillez visiter www.backyarddiscovery.com

Pour obtenir le manuel de montage le plus récent, pour enregistrer votre produit ou pour commander des pièces de rechange

Para obtener instrucciones en español, visite www.backyarddiscovery.com

FABRIQUÉE EN CHINE
INS-2303041-A-CARAWAY COTTAGE - WHITE-FR 06/04/24

MANUEL DE PROPRIÉTAIRE - DIMENSIONS DE PRÉPARATION ET NOTES IMPORTANTS

VOTRE CHOIX D'EMPLACEMENT DE LA CABANE EST TRÈS IMPORTANTE POUR LA SÉCURITÉ DE VOS ENFANTS ET L'INTÉGRITÉ DU PRODUIT.
L'aire de jeu sécuritaire fait référence à une zone s'étendant sur 2m au-delà de l'ensemble de jeu sur tous les côtés, y compris l'espace au-dessus de l'ensemble de jeu.

SCHÉMA DE L'aire de jeu sécuritaire

DIMENSIONS DE SOL

3'-7 1/4" [1.1 m] x 4'-2 1/4" [1.3 m]

ZONE DE JEU SÉCURITAIRE

16'-9 1/4" [5.1 m] x 17'-4 1/4" [5.3 m] x 11'-4" [3.5 m]

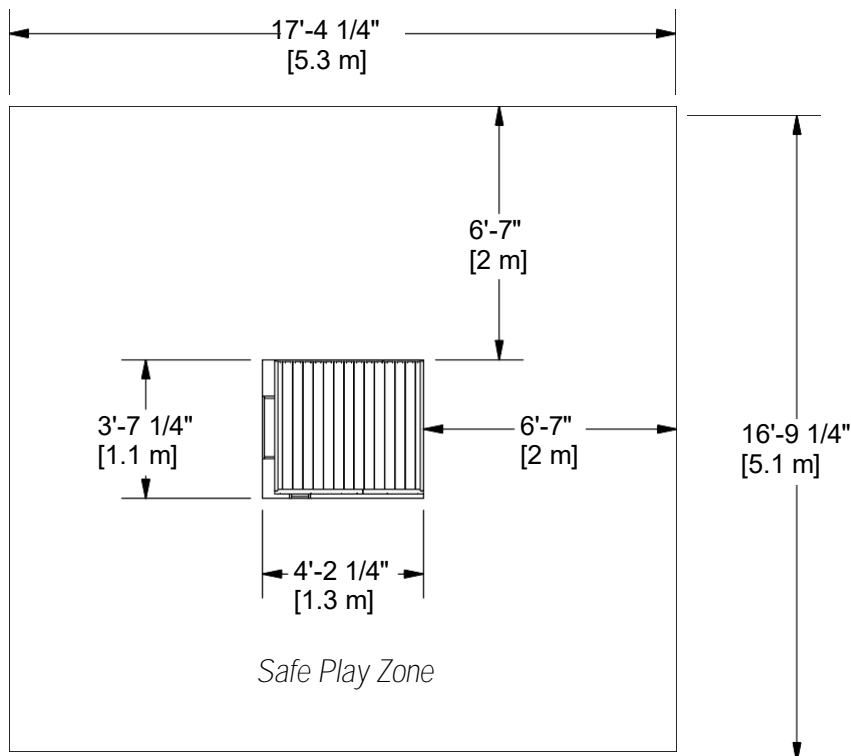

HAUTEUR DE JEU SÉCURITAIRE : 3,5M
HAUTEUR DE CHUTE MAXIMALE : 0,6M

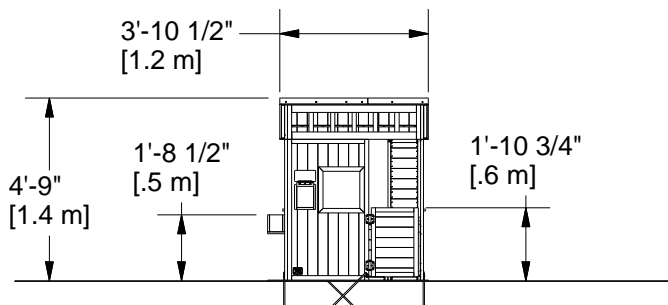

INFORMATIONS GÉNÉRALES

- LA CABANE A ÉTÉ CONÇUE UNIQUEMENT POUR LES ENFANTS À L'USAGE RÉSIDENTIELLE
- UN MAXIMUM DE 68 KG (150) EST RECOMMANDÉ POUR LES JEUX D'ENFANT INDIVIDUELS
- UN MAXIMUM DE 54 KG (120) EST RECOMMANDÉ POUR LES JEUX DE PLUSIEURS ENFANTS
- UN MAXIMUM DE 6 ENFANTS EST RECOMMANDÉ POUR CETTE CABANE

MANUEL DE PROPRIÉTAIRE - IDENTIFICATION DE PIÈCES

COMPONENTS EN BOIS (PAS À L'ÉCHELLE)

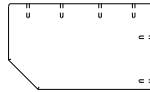

AD01 SUPPORT DE PLATEAU DE TABLE - W4L19818
(x1) 1"x4"x6 3/4" (24x102x172)

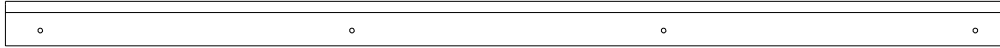

F01 GARNITURE DE TOIT - W4L19315
(x2) 1"x1 7/8"x41 7/8" (26x47x1064)

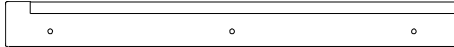

F03 GARNITURE DE TOIT - W4L19820
(x1) 1"x1 7/8"x18 7/8" (26x47x479)

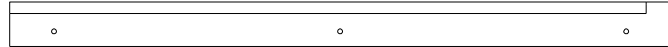

F02 GARNITURE DE TOIT - W4L19316
(x1) 1"x1 7/8"x27 1/2" (26x47x700)

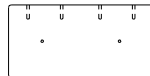

H01 SUPPORT DE PLATEAU DE TABLE - W4L19817
(x2) 1"x3 3/8"x6 3/4" (24x86x172)



J01 RAIL HAUT - W4L19308
(x1) 1"x1 3/8"x41 5/8" (24x34x1057)



K01 PLANCHE AVANT DE JARDINIÈRE - W4L19311
(x1) 5/8"x5 1/4"x19 1/2" (16x134x495)



K02 PLANCHE ARRIÈRE DE JARDINIÈRE - W4L19312
(x1) 5/8"x5 1/4"x19 1/2" (16x134x495)

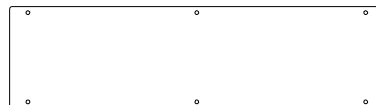

K03 PLANCHE ARRIÈRE DE JARDINIÈRE - W4L19314
(x1) 5/8"x5 1/4"x19 1/2" (16x134x495)

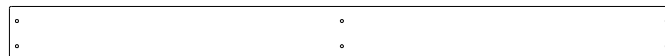

M02 PLATEAU DE TABLE - W4L19816
(x2) 5/8"x3 3/8"x41 5/8" (16x86x1056)

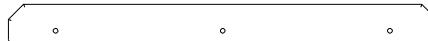

N01 PLANCHE DE FENÊTRE - W4L19309
(x2) 5/8"x1 5/8"x17 7/8" (16x40x454)

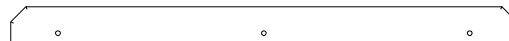

N02 PLANCHE DE FENÊTRE - W4L19310
(x1) 5/8"x1 5/8"x21 1/8" (16x40x536)

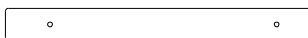

N04 GARNITURE DE TOIT - W4L19819
(x1) 5/8"x1 3/8"x12 3/4" (16x34x324)

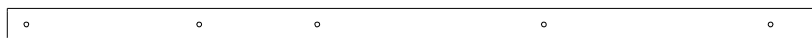

N03 GARNITURE DE TOIT - W4L19317
(x1) 5/8"x1 3/8"x33 5/8" (16x34x855)



Y01 PLANCHE DE CÔTÉ DE JARDINIÈRE - W4L19313
(x2) 5/8"x4"x5 1/4" (16x102x134)

MANUEL DE PROPRIÉTAIRE - IDENTIFICATION DE PIÈCES

COMPONENTS EN BOIS (PAS À L'ÉCHELLE)

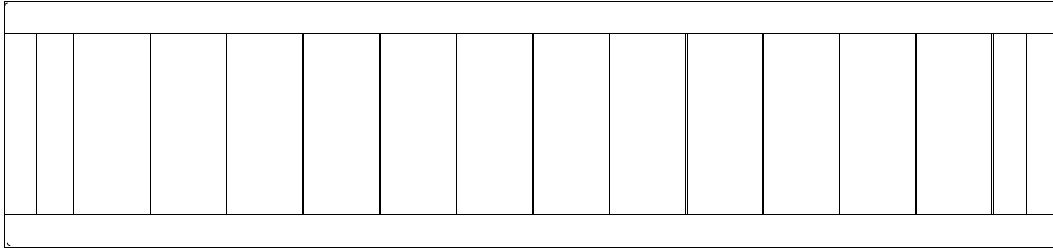

WP01 PANNEAU MURAUX - W2A04117
(x1) 1"x10 1/4"x43 7/8" (24x260x1115)

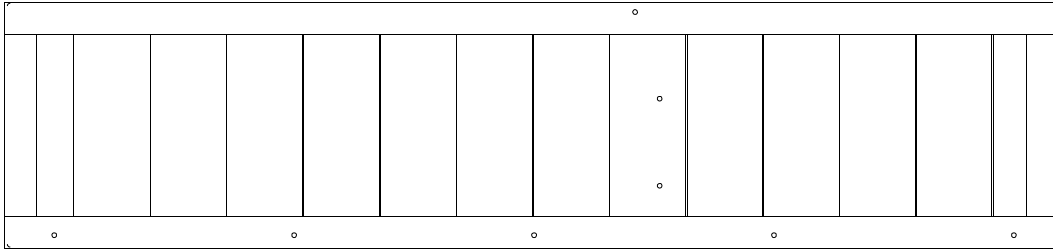

WP02 PANNEAU MURAUX - W2A04118
(x1) 1"x10 1/4"x43 7/8" (24x260x1115)

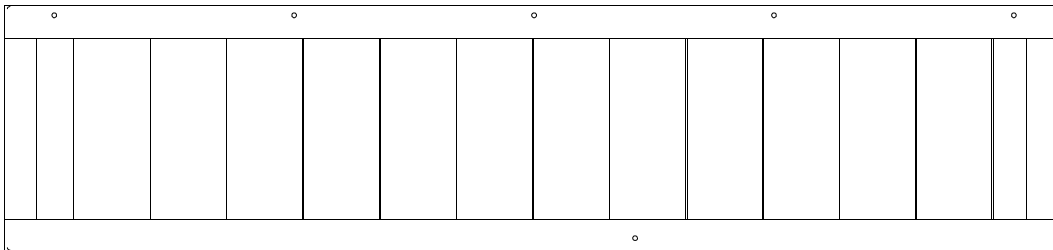

WP03 PANNEAU MURAUX - W2A04119
(x1) 1"x10 1/4"x43 7/8" (24x260x1115)

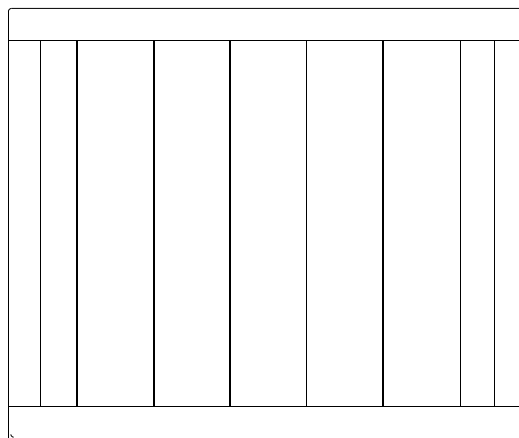

WP04 PANNEAU MURAUX - W2A04120
(x2) 1"x10 1/4"x43 7/8" (24x455x548)

MANUEL DE PROPRIÉTAIRE - IDENTIFICATION DE PIÈCES

COMPONENTS EN BOIS (PAS À L'ÉCHELLE)

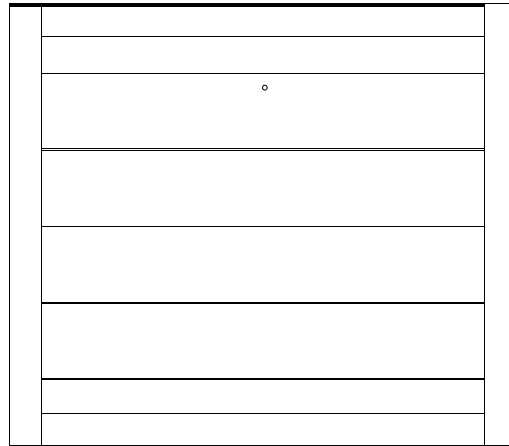

WP05 PANNEAU MURAUX - W2A04121

(x1) 1"x18 3/8"x21 1/8" (24x467x537)

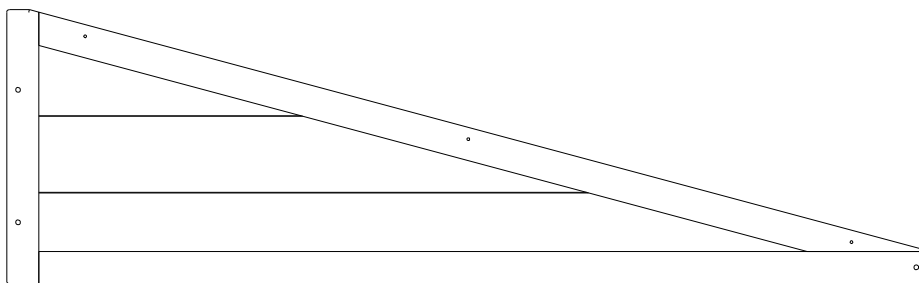

WP06 PANNEAU MURAUX - W2A04122

(x1) 1"x11 3/8"x38 3/8" (24x290x975)

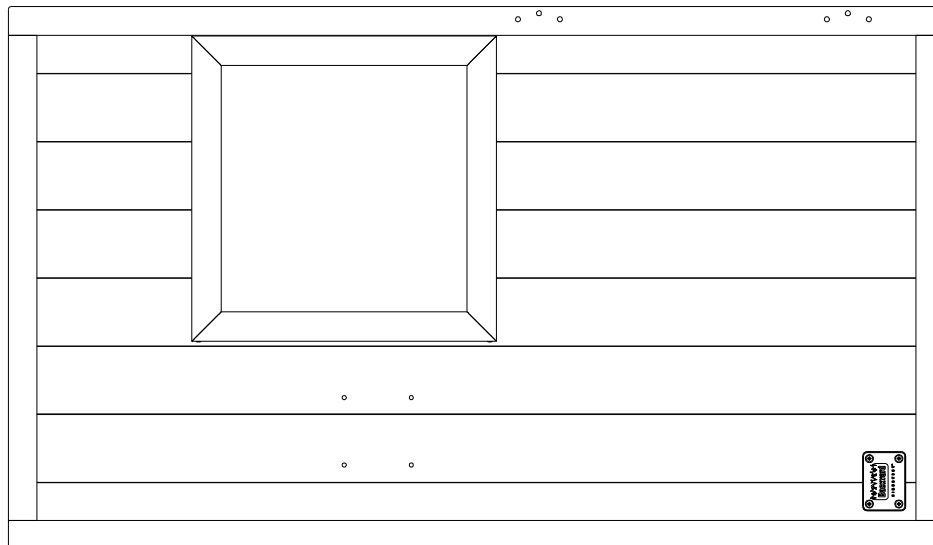

WP07 PANNEAU MURAUX - W2A04123

(x1) 1"x10 1/4"x43 7/8" (24x645x1115)

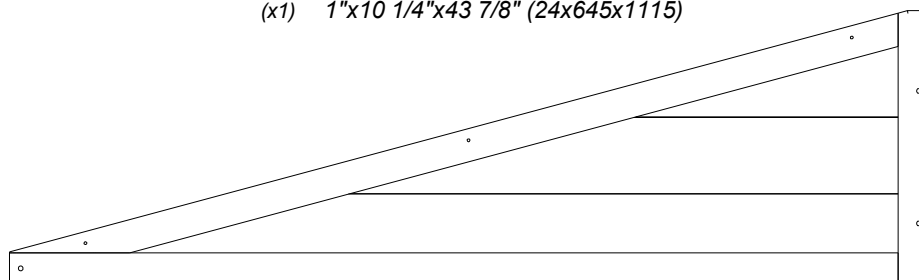

WP08 PANNEAU MURAUX - W2A04124

(x1) 1"x11 3/8"x38 3/8" (24x290x975)

MANUEL DE PROPRIÉTAIRE - IDENTIFICATION DE PIÈCES

COMPONENTS EN BOIS (PAS À L'ÉCHELLE)

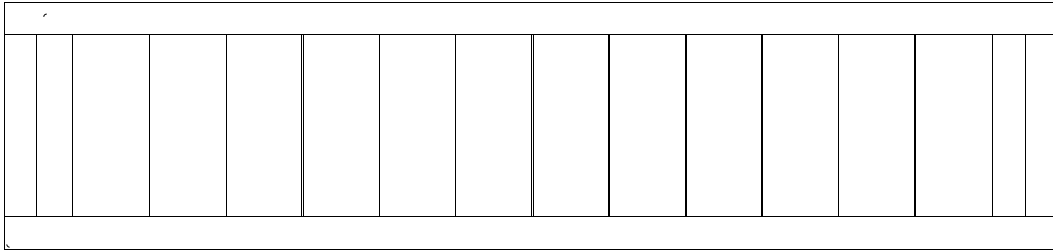

WP09 PANNEAU MURAUX - W2A04126

(x1) 1"x10 1/4"x43 7/8" (24x260x1115)

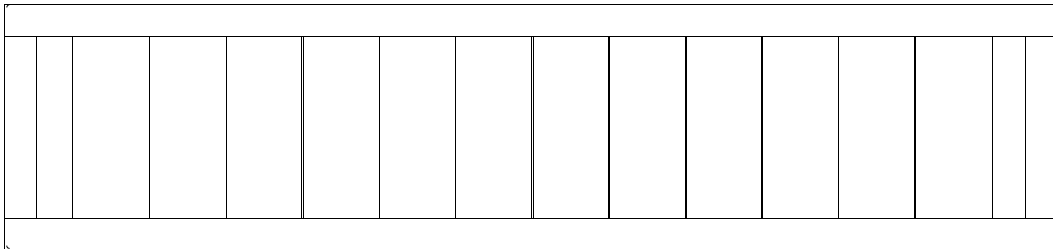

WP10 PANNEAU MURAUX - W2A04127

(x1) 1"x10 1/4"x43 7/8" (24x260x1115)

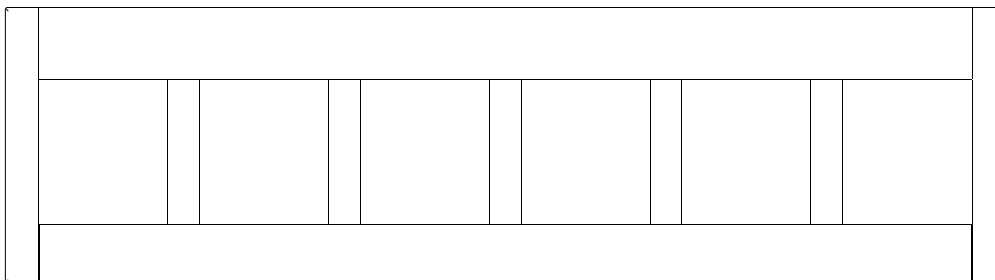

WP11 PANNEAU MURAUX - W2A04128

(x1) 15/16"x11 7/16"x41 5/8" (24x290x1057)

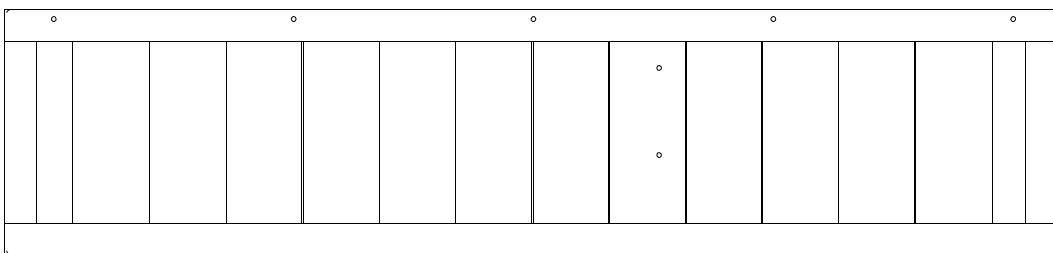

WP12 PANNEAU MURAUX - W2A04132

(x1) 1"x10 1/4"x43 7/8" (24x260x1115)

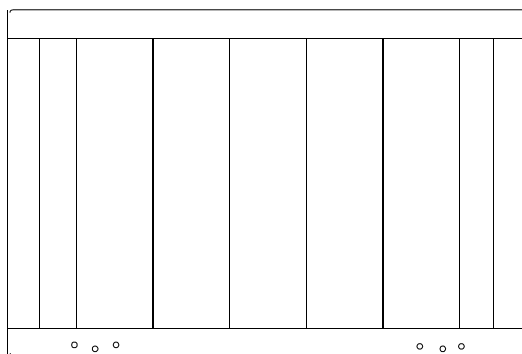

DP01 PANNEAU DE LA PORTE -

(x1) **W2A04125**

1"x10 1/4"x43 7/8" (24x374x548)

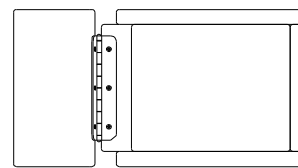

MB01 BOÎTE AUX LETTRES - W2A04129

(x1) 3 3/8"x6 9/16"x8 3/4" (86x166x222)

MANUEL DE PROPRIÉTAIRE - IDENTIFICATION DE PIÈCES

COMPONENTS EN BOIS (PAS À L'ÉCHELLE)

RP01 PANNEAU DE TOIT - W2A04130

(x1) 1 3/8"x24 5/8"x41 7/8" (35x625x1064)

RP02 PANNEAU DE TOIT - W2A04131

(x1) 1 3/8"x21 1/8"x41 7/8" (35x535x1064)

MANUEL DE PROPRIÉTAIRE - IDENTIFICATION DE PIÈCES

PIÈCES DE QUINCAILLERIE

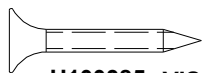

H100385 VIS PFH BLK
(x4) 8x1

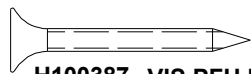

H100387 VIS PFH BLK
(x25) 8x1 1/4

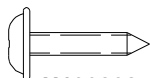

H100202 VIS PWH BLK
(x2) 8x5/8

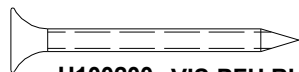

H100200 VIS PFH BLK
(x39) 8x1 1/2

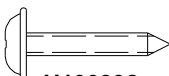

H100392 VIS PWH BLK
(x71) 8x3/4

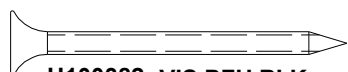

H100382 VIS PFH BLK
(x6) 8x1 3/4

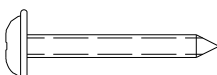

H100797 VIS PWH BLK
(x4) 8x1

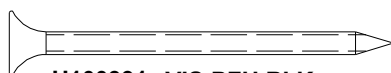

H100391 VIS PFH BLK
(x23) 8x2

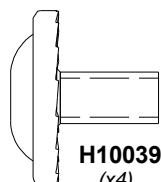

H100396 BOULON WH BLK
(x4) 5/16x1/2

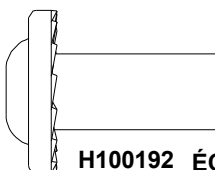

H100192 ÉCROU À BARILLET WH BLK
(x4) 5/16x7/8

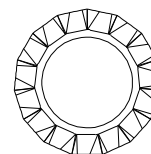

H100199 RONDELLE D'ARRÊT EXT BLK
(x4) 12x19

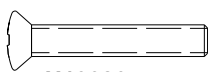

H100807 VIS POH BLK
(x12) 8/32x1



H100804 ÉCROU EN T
(x12) 8/32

MANUEL DE PROPRIÉTAIRE - IDENTIFICATION DE PIÈCES

PIÈCES ACCESSOIRES (PAS À L'ÉCHELLE)

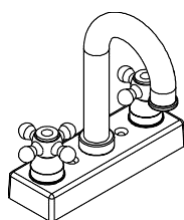

A6P00024
(x1) **MONTAGE DE ROBINET**

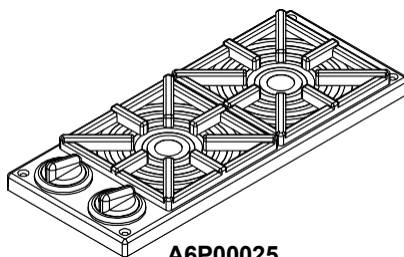

A6P00025
(x1) **MONTAGE DE CUISINIÈRE**

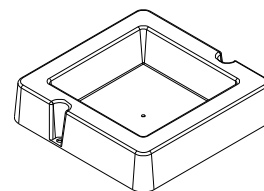

A6P00032
(x1) **MONTAGE DE ÉVIER**



A6P00336
(x1) **CASSEROLE**



A6P00338
(x1) **POÊLE**



A6P00337
(x1) **COUVERCLE**



A6P00339
(x1) **SPATULE**



A6P00340
(x1) **LOUCHE**

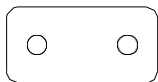

A4M02752
(x8) **TRIQUET**

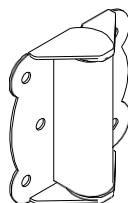

A4M00624 **GOND DE PORTE À RESSORT**
(x1)

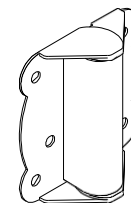

A4M00994 **GOND DE PORTE**
(x1)

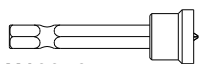

H100764
(x1) **VIS RÉGULATEUR**

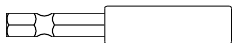

H101100
(x1) **MANDRIN MAGNÉTIQUE**

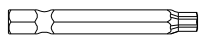

H100147
(x1) **T-30 MÈCHE TORX**

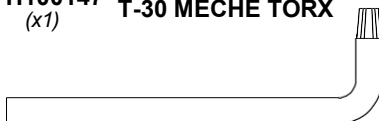

H100114
(x1) **T-30 CLIQUET TORX**

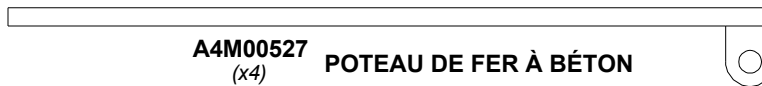

A4M00527
(x4) **POTEAU DE FER À BÉTON**

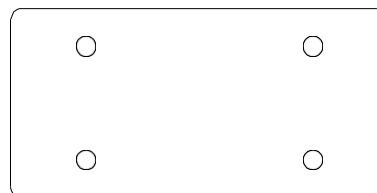

A4M02100
(x12) **TRIQUET**



A4M02754
(x1) **SANGLE EN MÉTAUX**

ÉTAPE 1 DE PRÉ-ASSEMBLAGE - TRI DES PIÈCES

Il est essentiel pour faciliter l'assemblage que vous preniez le temps de trier et d'organiser le bois et la quincaillerie.

PIÈCES EN BOIS :

- Organisez les pièces de bois selon le numéro alphanumérique à trois chiffres estampillé sur chaque planche (ex. P01).
- S'il y a plusieurs planches avec le même numéro estampillé, empilez ces pièces ensemble.
- Les tampons se trouvent sur la surface plane ou aux extrémités des planches.
- Prévoyez beaucoup d'espace - les pièces de bois peuvent prendre beaucoup de place.

REMARQUE : LES CARTONS NE SONT PAS ORGANISÉS PAR NUMÉRO DE PLANCHE.

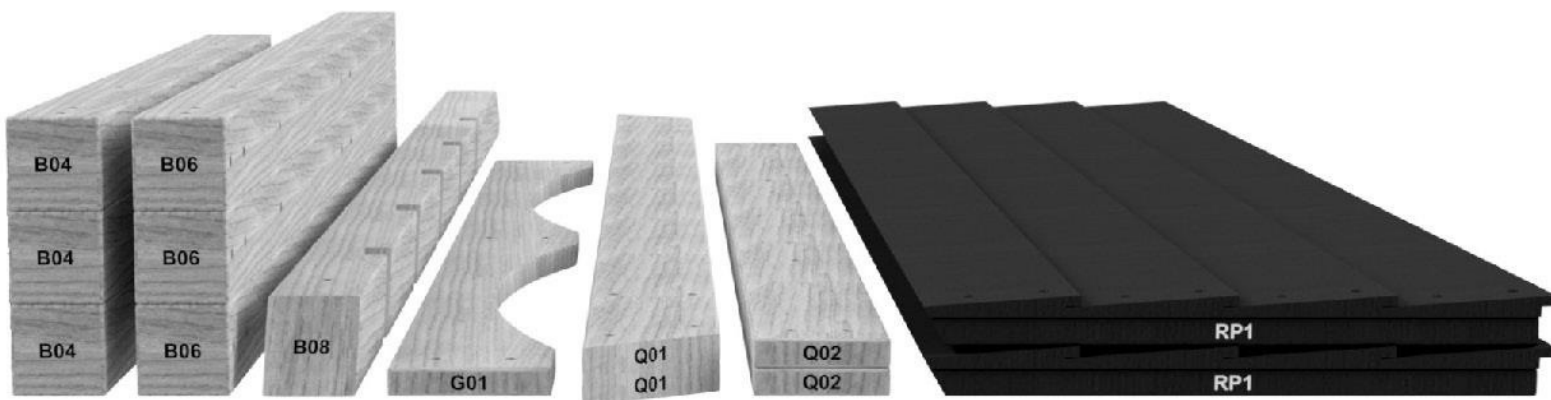

PIÈCES DE QUINCAILLERIE :

- Nous vous recommandons d'avoir une table séparée pour organiser les pièces de quincaillerie.
- Les sacs de pièces de quincaillerie comportent un numéro de pièce alphanumérique à sept chiffres.
- Vous pouvez organiser vos pièces de quincaillerie par numéro de pièce ou les grouper par type de pièce (c.-à-d. boulons, écrous, etc.).
- Lors de l'assemblage, il vous suffit de vous reporter aux quatre derniers chiffres du numéro.



PRÉ-ASSEMBLAGE ÉTAPE 2 - OUTILS NÉCESSAIRES



PERCEUSE SANS
FIL OU
PERCEUSE
ÉLECTRIQUE



ACCESSOIRES DE LA
PERCEUSE : MÈCHE
CRUCIFORME



FORETS DE 1/8 PO, 3/16
PO, 3/8 PO ET 7/16 PO



TOURNEVIS CRUCIFORME



CLÉS OUVERTES DE
1/2 PO ET 9/16 PO



CLÉ À CLIQUET DE 3/8 PO,
DOUILLES STANDARD DE 1/2 PO
ET 7/16 PO, DOUILLES
PROFONDES DE 1/2 PO ET 7/16 PO



MARTEAU À PANNE FENDUE

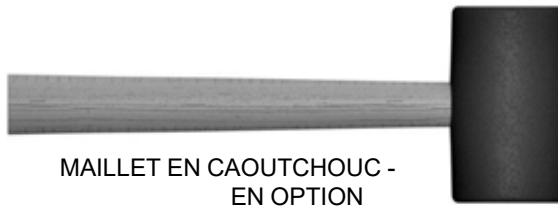

MAILLET EN CAOUTCHOUC -
EN OPTION

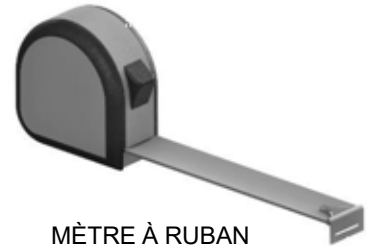

MÈTRE À RUBAN

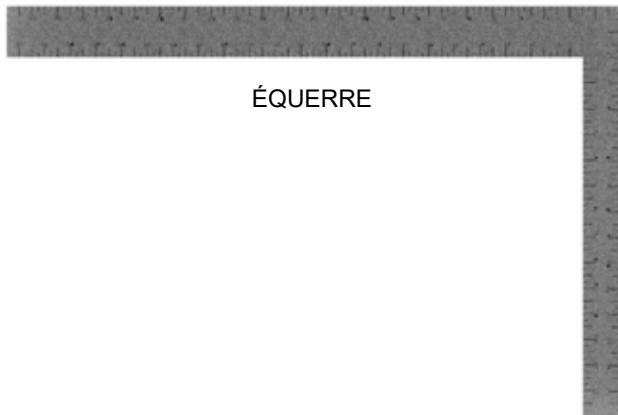

ÉQUERRE



NIVEAU DE 24 PO

ÉTAPE 1 - JARDINIÈRE

QTÉ	N° DE PIÈCES	DESCRIPTION
4	H100200	VIS PFH 8x1-1/2 BLK



K01 PLANCHE AVANT DE
JARDINIÈRE - W4L19311
(x1)
5/8"x5 1/4"x19 1/2" (16x134x495)

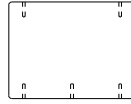

Y01 PLANCHE DE CÔTÉ DE
JARDINIÈRE - W4L19313
(x2)
5/8"x4"x5 1/4" (16x102x134)

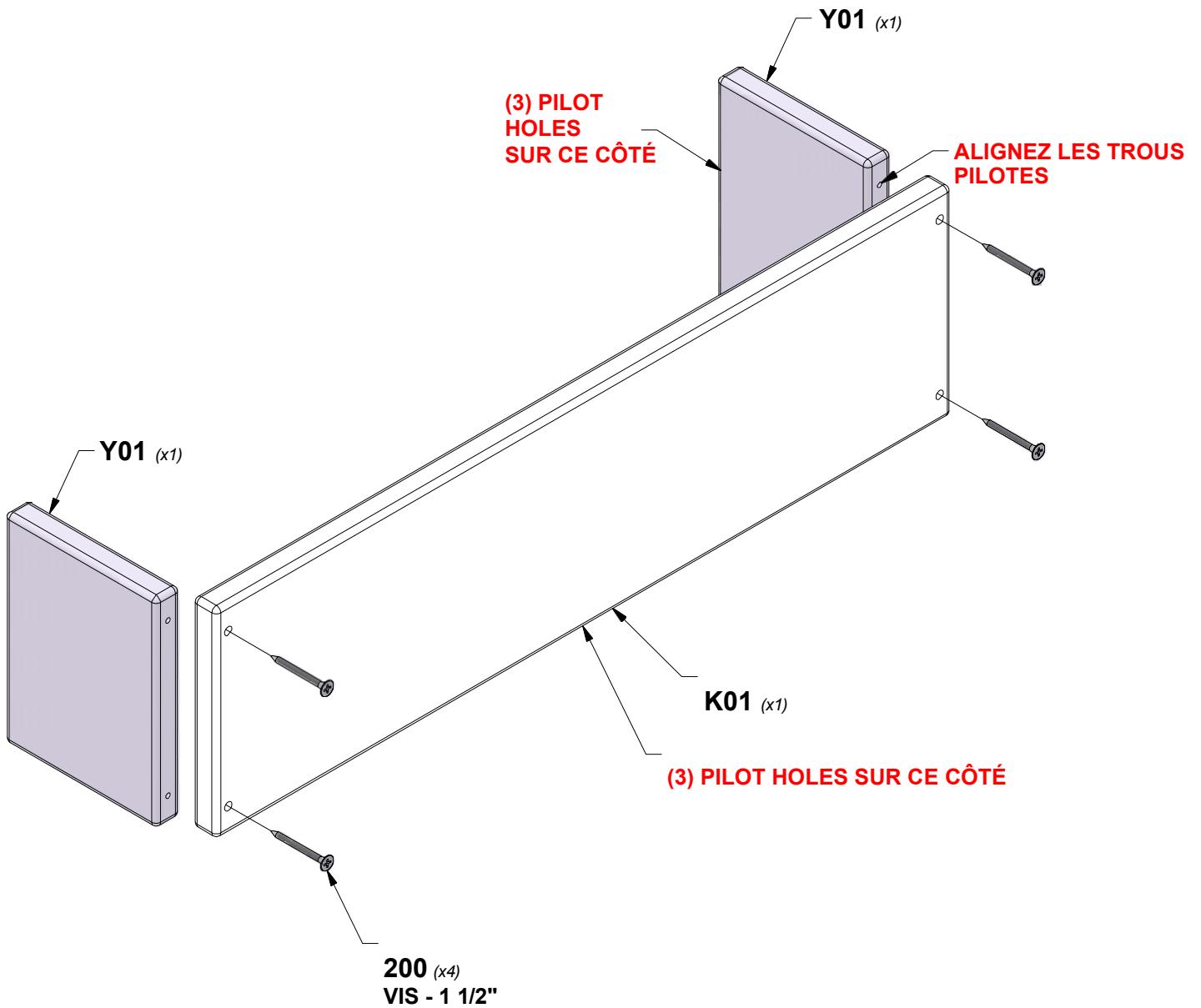

ÉTAPE 2 - JARDINIÈRE

QTÉ	N° DE PIÈCES	DESCRIPTION
4	H100200	VIS PFH 8x1-1/2 BLK

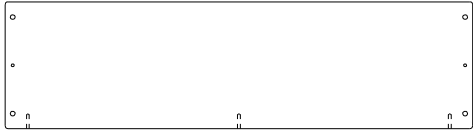

K02 PLANCHE ARRIÈRE DE JARDINIÈRE - W4L19312
(x1) 5/8"x5 1/4"x19 1/2" (16x134x495)

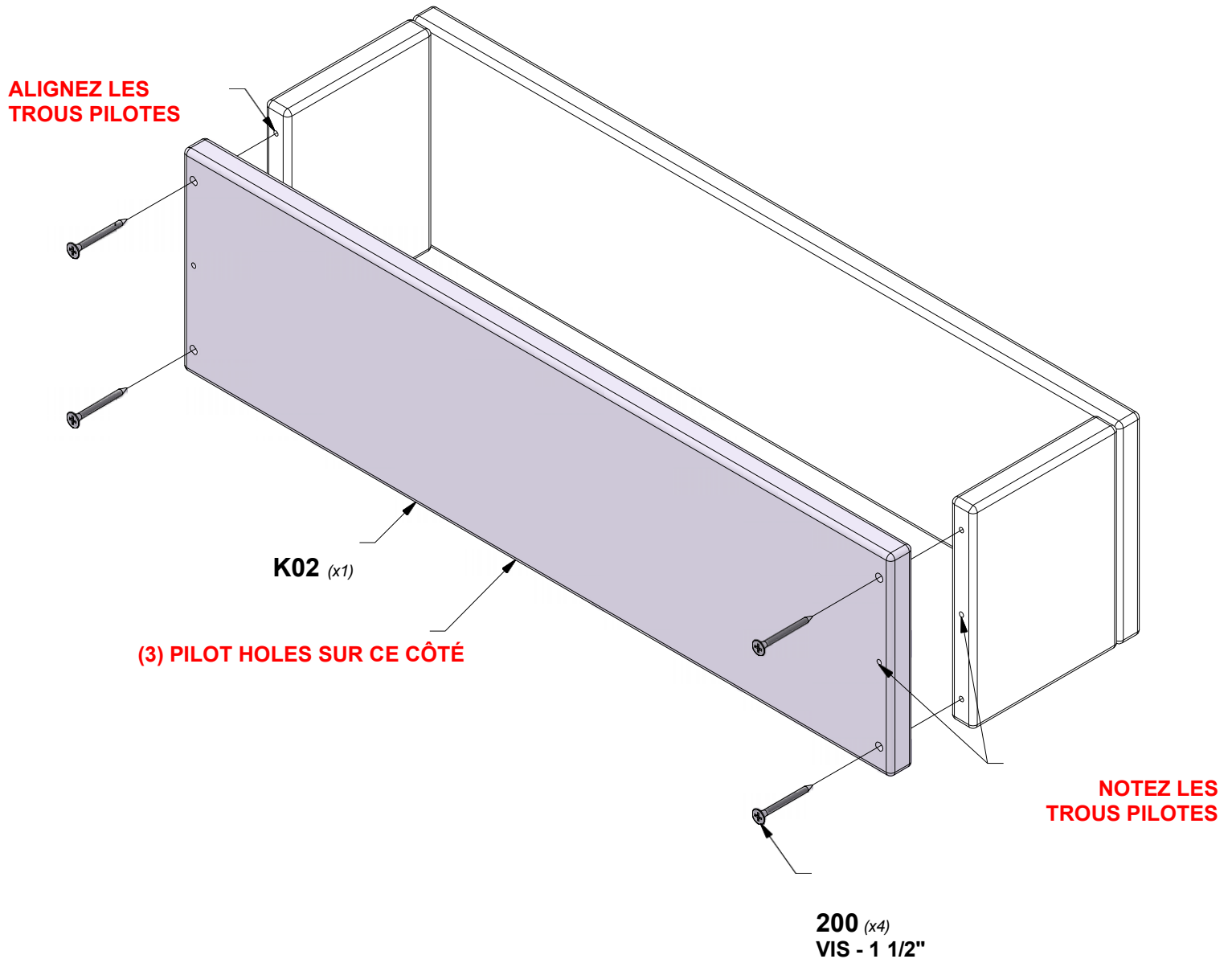

ÉTAPE 3 - JARDINIÈRE

QTÉ	N° DE PIÈCES	DESCRIPTION
6	H100200	VIS PFH 8x1-1/2 BLK

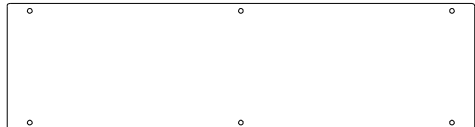

K03 PLANCHE ARRIÈRE DE JARDINIÈRE - W4L19314
(x1) 5/8"x5 1/4"x19 1/2" (16x134x495)

ALIGNEZ LES TROUS PILOTES

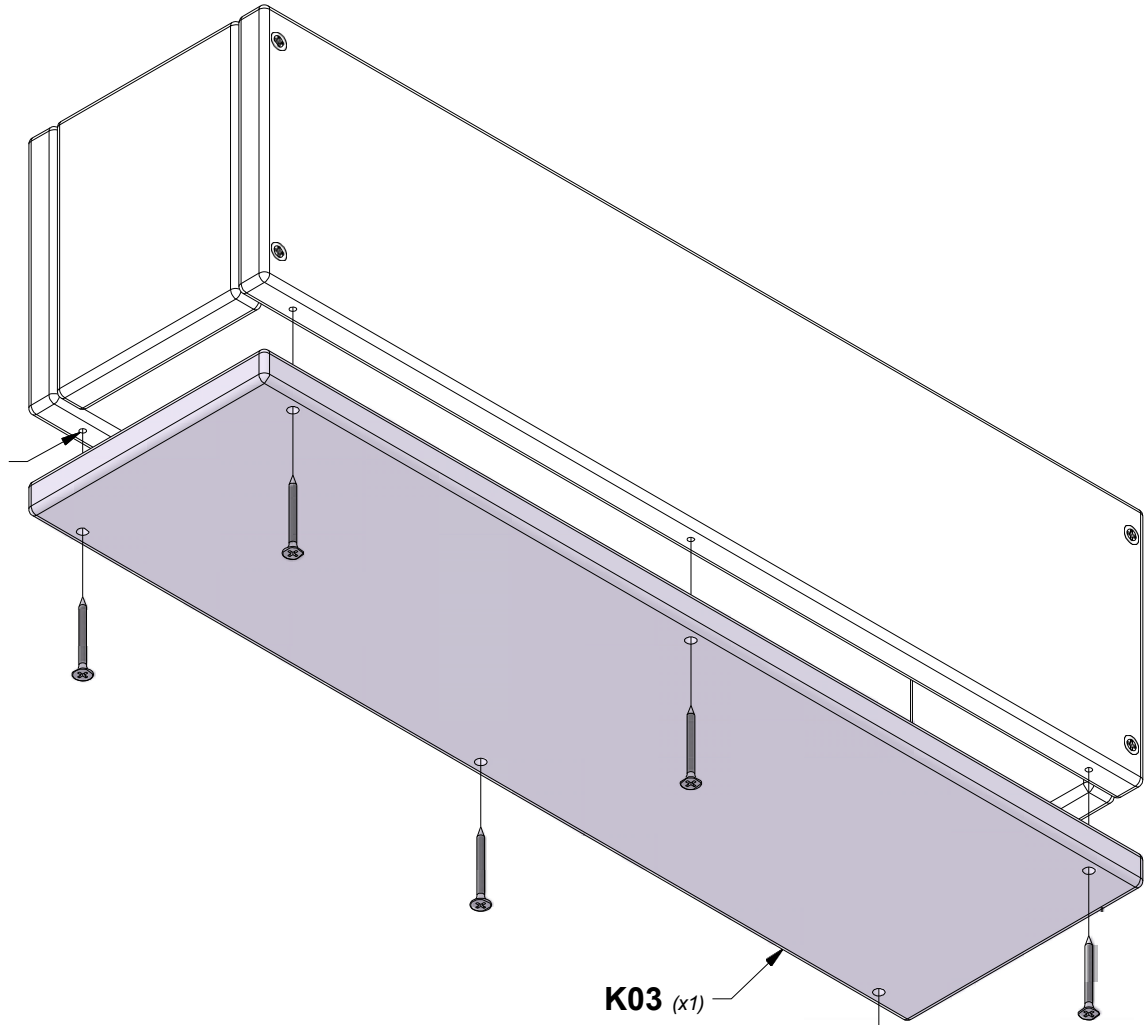

K03 (x1)

200 (x6)

VIS - 1 1/2"

ÉTAPE 1 - ASSEMBLAGE DE CABANE

QTÉ	N° DE PIÈCES	DESCRIPTION
5	H100391	VIS PFH 8x2 BLK

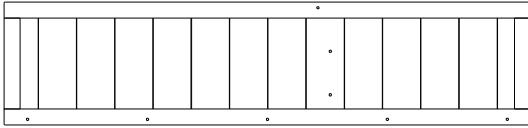

WP02 PANNEAU MURAUX - W2A04118
(x1) 1"x10 1/4"x43 7/8" (24x260x1115)

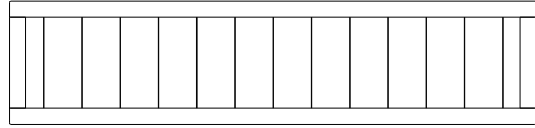

WP01 PANNEAU MURAUX - W2A04117
(x1) 1"x10 1/4"x43 7/8" (24x260x1115)

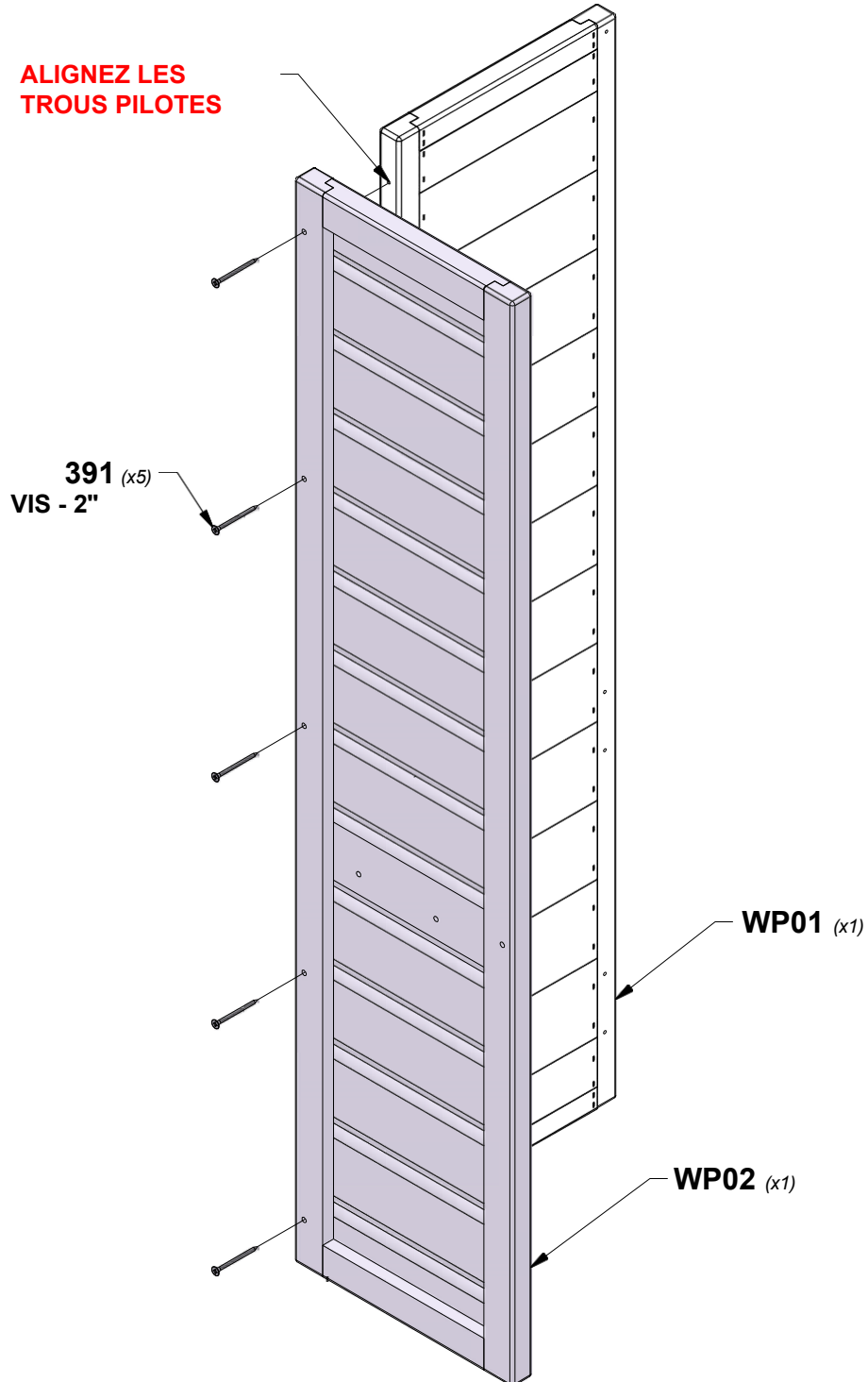

ÉTAPE 2 - ASSEMBLAGE DE CABANE

QTÉ	N° DE PIÈCES	DESCRIPTION
8	H100392	VIS PWH 8x3/4 BLK

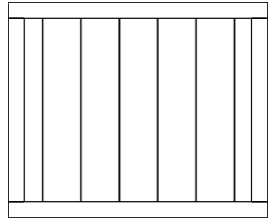

WP04 PANNEAU MURAUX W2A04120
(x1) 1"x10 1/4"x43 7/8" (24x455x548)

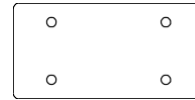

A4M02100 TRIQUET
(x2)

ASTUCE:
ALIGNEZ LES TROUS PILOTES

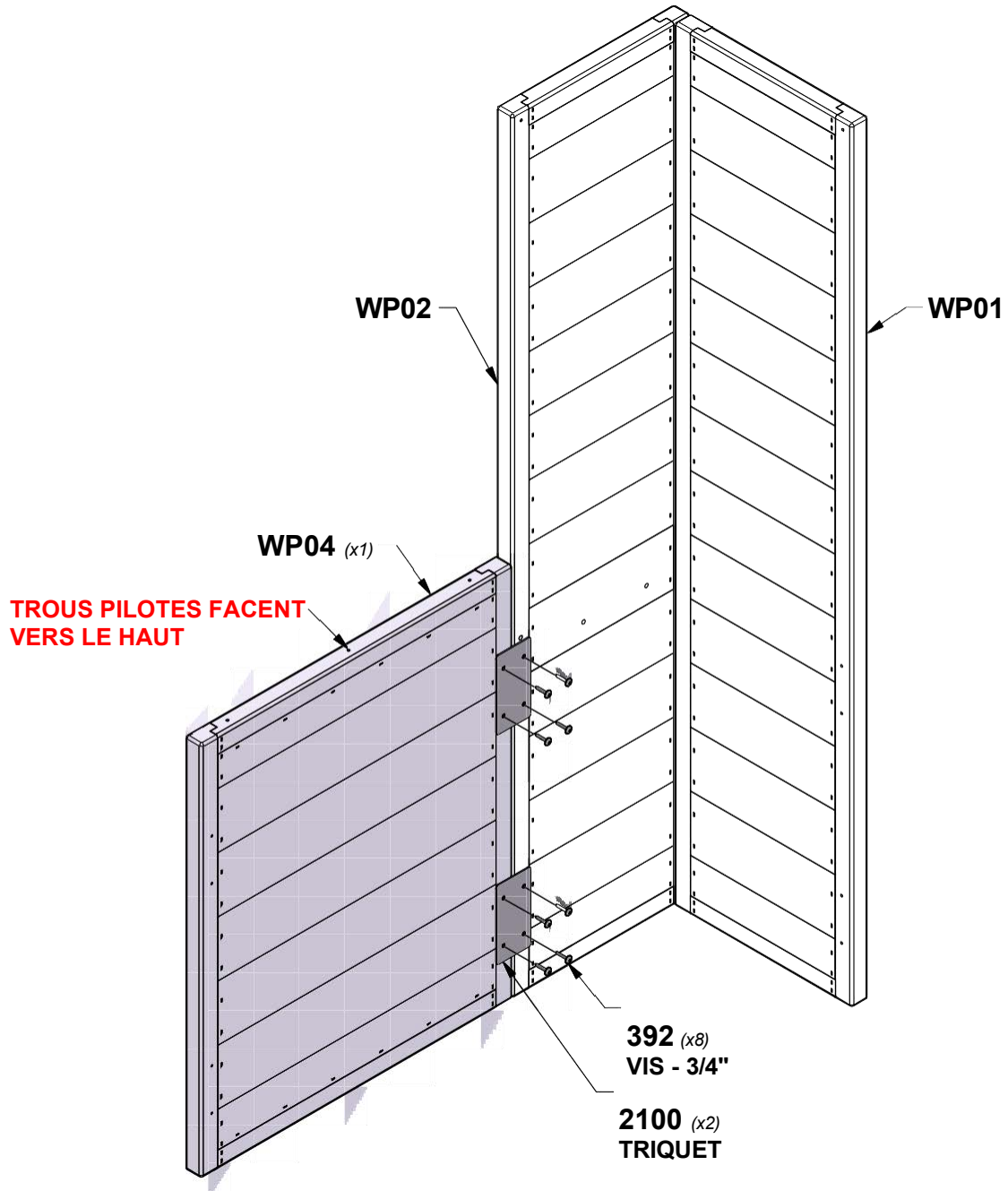

ÉTAPE 3 - ASSEMBLAGE DE CABANE

QTÉ	N° DE PIÈCES	DESCRIPTION
8	H100392	VIS PWH 8x3/4 BLK

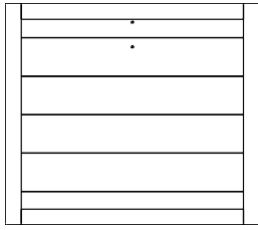

WP05 PANNEAU MURAUX - W2A04121
(x1) 1"x18 3/8"x21 1/8" (24x467x537)

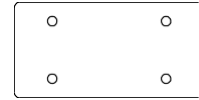

A4M02100 TRIQUET
(x2)

ASTUCE :
ALIGNEZ LES TROUS PILOTES

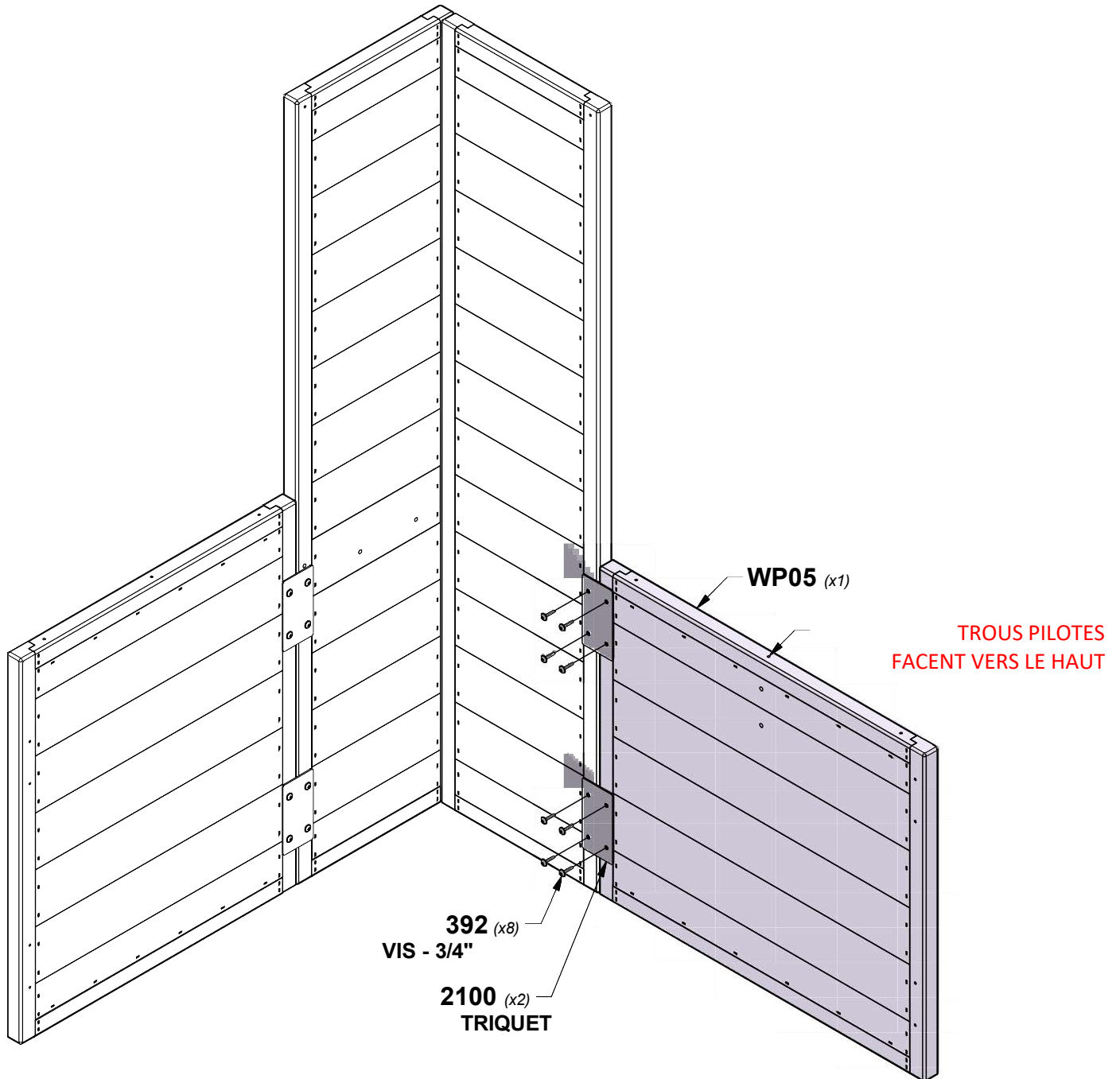

ÉTAPE 4 - ASSEMBLAGE DE CABANE

QTÉ	N° DE PIÈCES	DESCRIPTION
8	H100392	VIS PWH 8x3/4 BLK

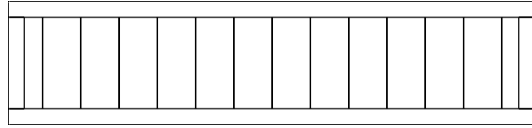

WP09
(x1) **PANNEAU MURAUX - W2A04126**
1"x10 1/4"x43 7/8" (24x260x1115)



A4M02100
(x2) **TRIQUET**

ASTUCE:
ALIGNEZ LES TROUS PILOTES

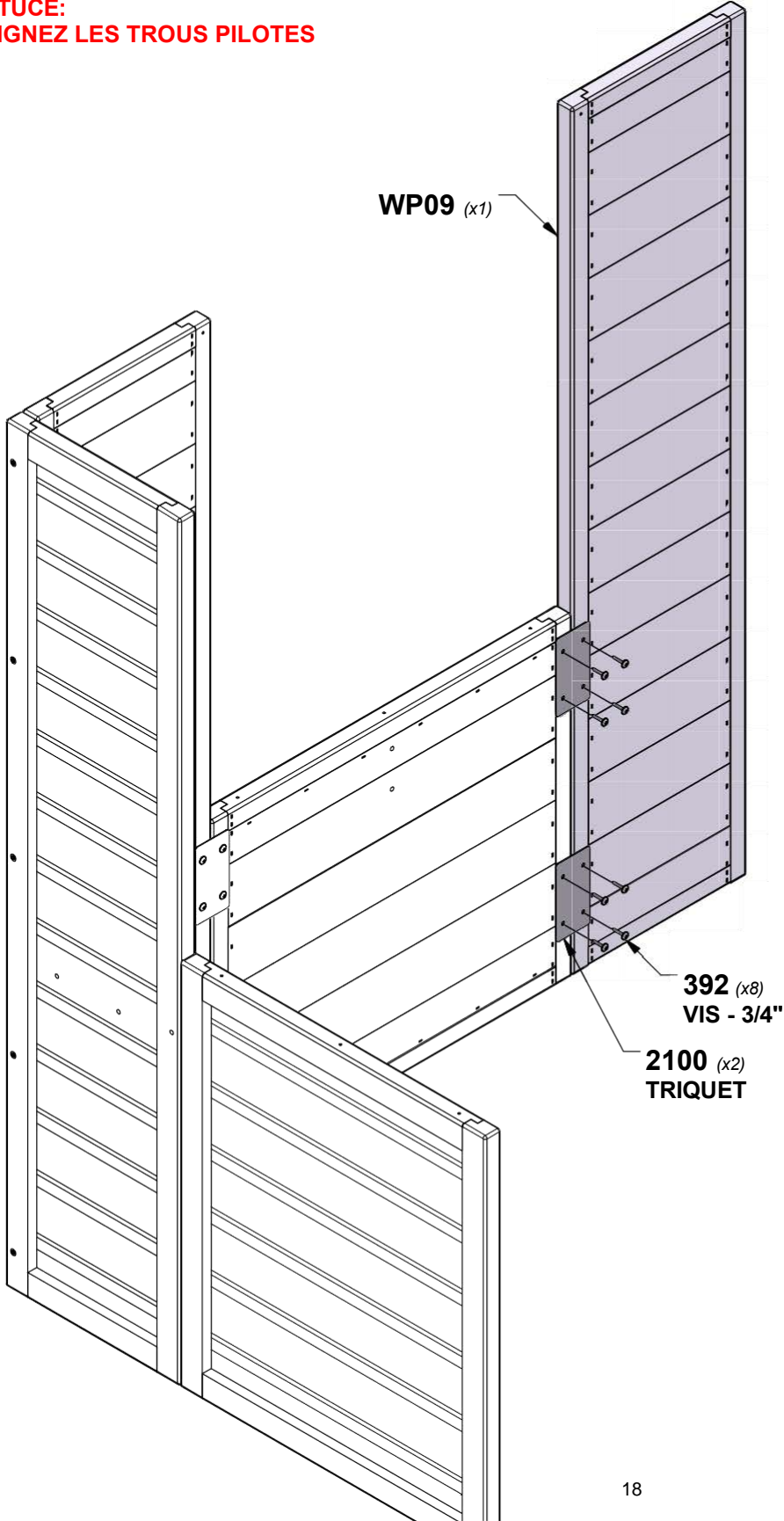

ÉTAPE 5 - ASSEMBLAGE DE CABANE

QTÉ	N° DE PIÈCES	DESCRIPTION
5	H100391	VIS PFH 8x2 BLK

WP12 PANNEAU MURAUX - W2A04132
(x1) 1"x10 1/4"x43 7/8" (24x260x1115)

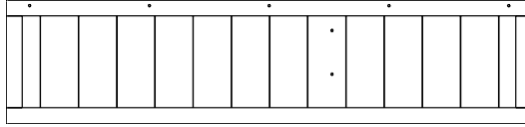

ASTUCE:
ALIGNEZ LES TROUS PILOTES

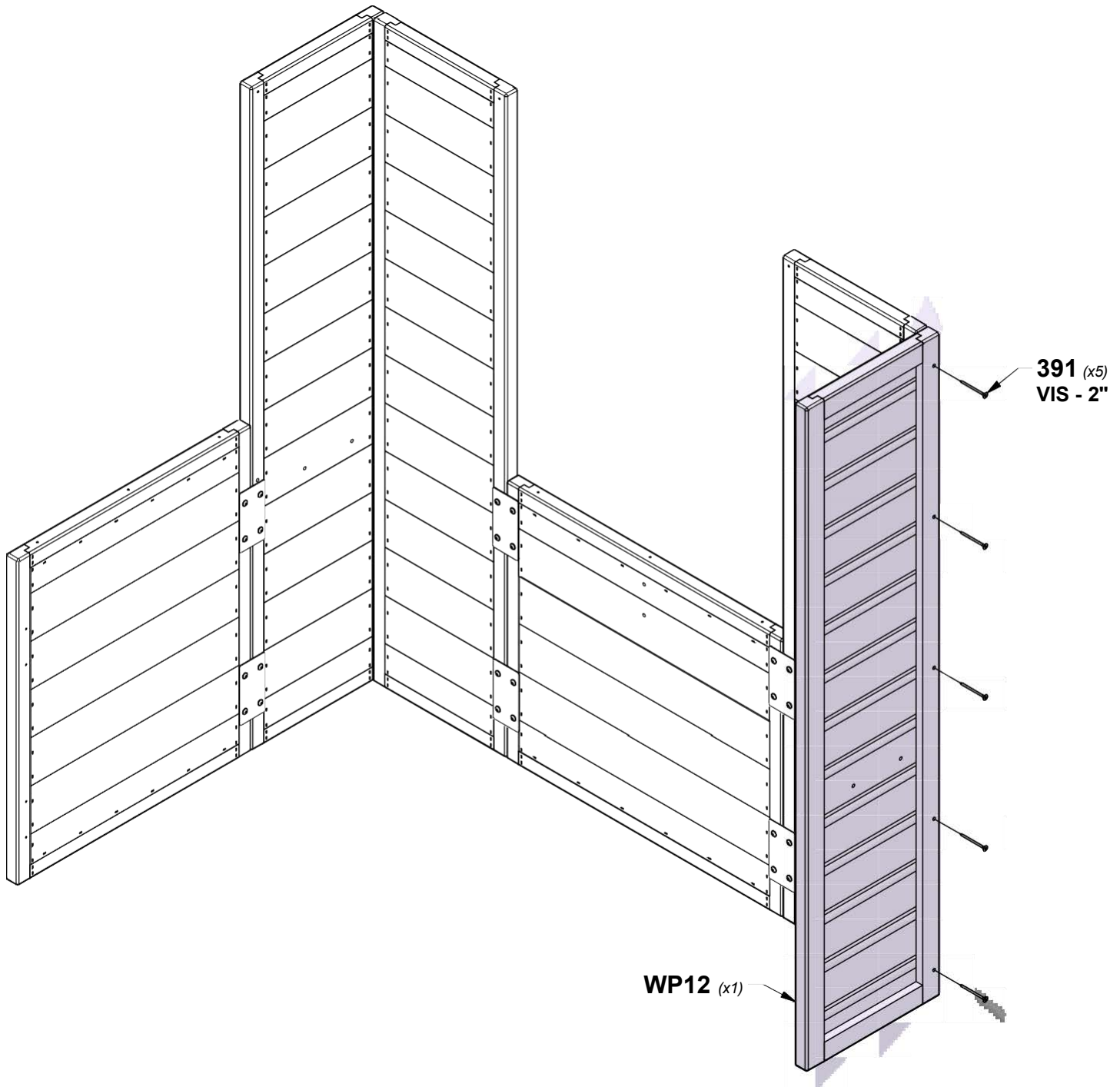

ÉTAPE 6 - ASSEMBLAGE DE CABANE

QTÉ	N° DE PIÈCES	DESCRIPTION
8	H100392	VIS PWH 8x3/4 BLK

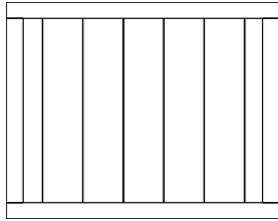

WP04
(x1)
PANNEAU MURAUX -
W2A04120
1"x10 1/4"x43 7/8" (24x455x548)



A4M02100
(x2) **TRIQUET**

ASTUCE:
ALIGNER LES TROUS PILOTES

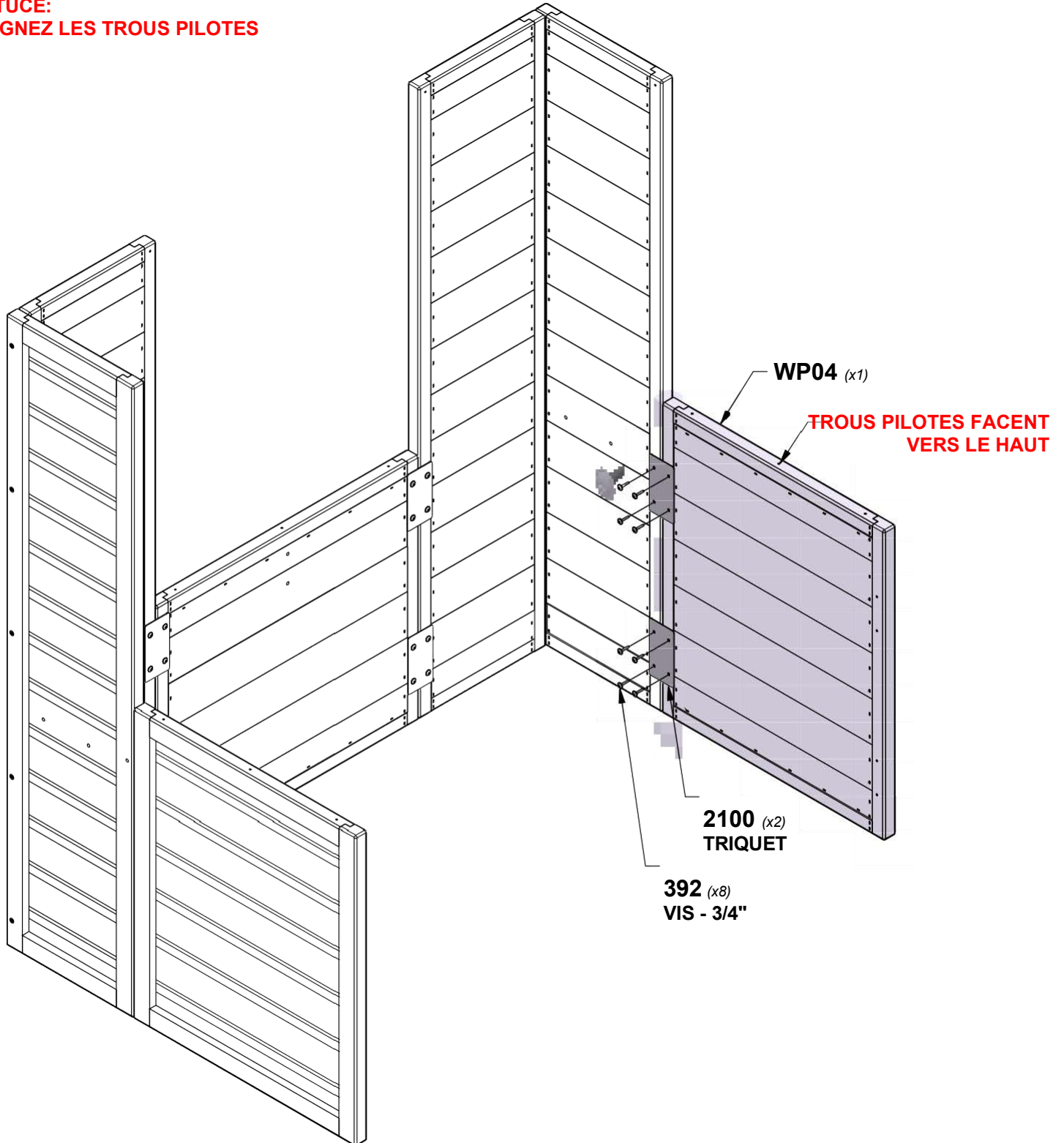

ÉTAPE 7 - ASSEMBLAGE DE CABANE

QTÉ	N° DE PIÈCES	DESCRIPTION
8	H100392	VIS PWH 8x3/4 BLK

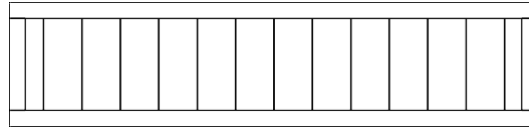

WP10 PANNEAU MURAUX – (x1)
W2A04127
1''x10 1/4''x43 7/8'' (24x260x1115)



A4M02100 TRIQUET
(x2)

ASTUCE:
ALIGNEZ LES TROUS PILOTES

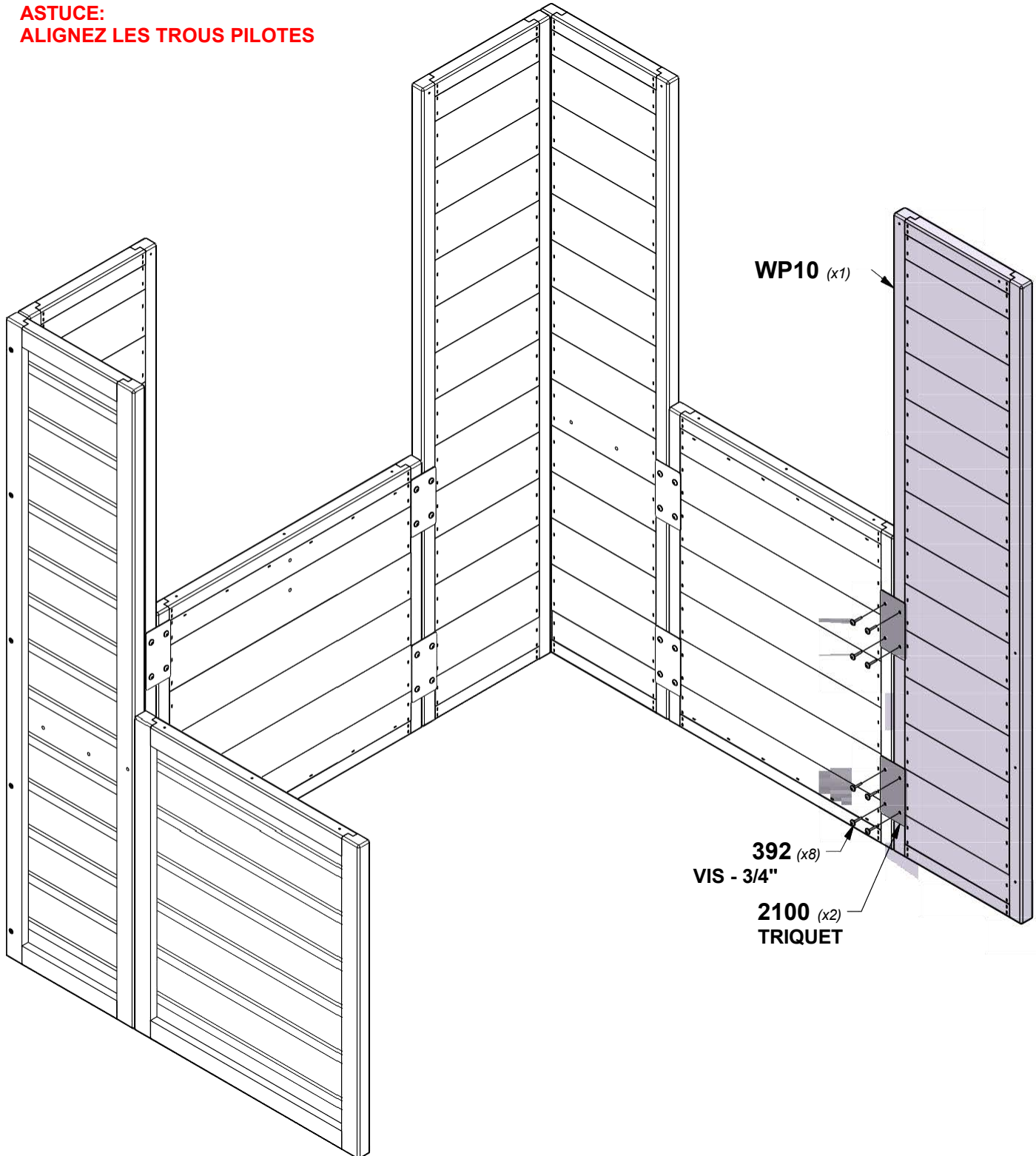

ÉTAPE 8 - ASSEMBLAGE DE CABANE

QTÉ	N° DE PIÈCES	DESCRIPTION
8	H100392	VIS PWH 8x3/4 BLK

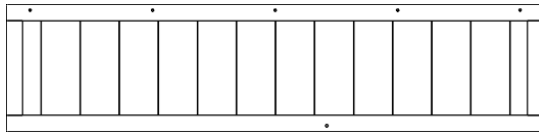

WP03 PANNEAU MURAUX - W2A04119
(x1) 1"x10 1/4"x43 7/8" (24x260x1115)

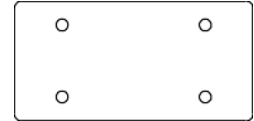

A4M02100 TRIQUET
(x2)

ASTUCE:
ALIGNEZ LES TROUS PILOTES

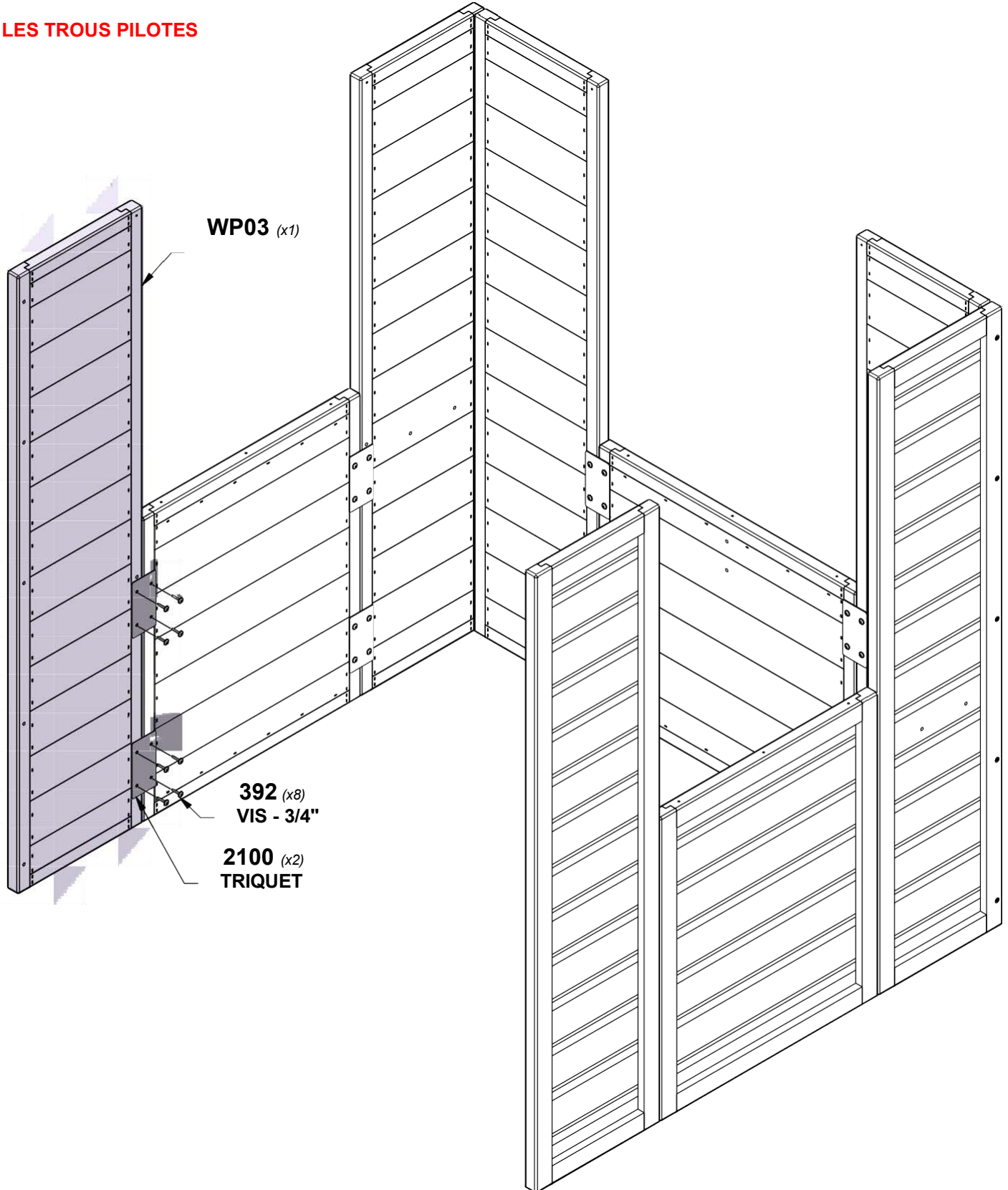

ÉTAPE 9 - ASSEMBLAGE DE CABANE

QTÉ	N° DE PIÈCES	DESCRIPTION
5	H100391	VIS PFH 8x2 BLK

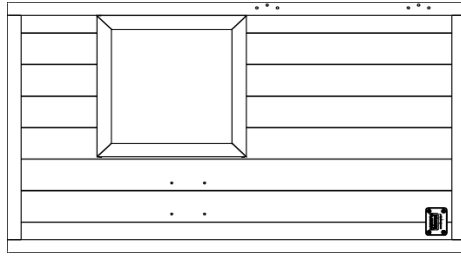

WP07 PANNEAU MURAUX - W2A04123
(x1) 1"x10 1/4"x43 7/8" (24x645x1115)

ASTUCE:
ALIGNEZ LES TROUS PILOTES

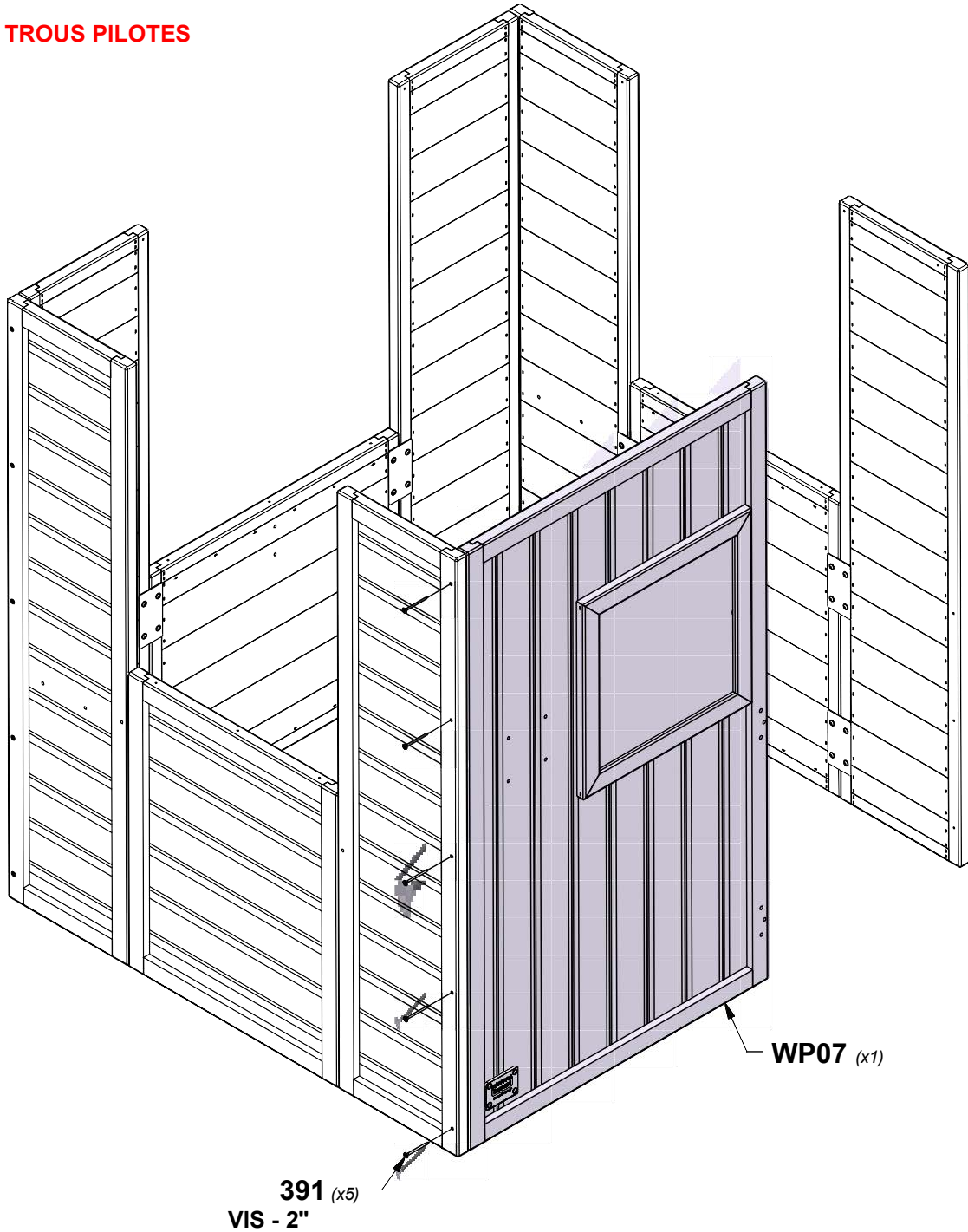

ÉTAPE 10 - ASSEMBLAGE DE CABANE

QTÉ	N° DE PIÈCES	DESCRIPTION
7	H100392	VIS PWH 8x3/4 BLK



A4M02754
(x1) SANGLE EN MÉTAUX

ASTUCE:
ALIGNEZ LES TROUS PILOTES

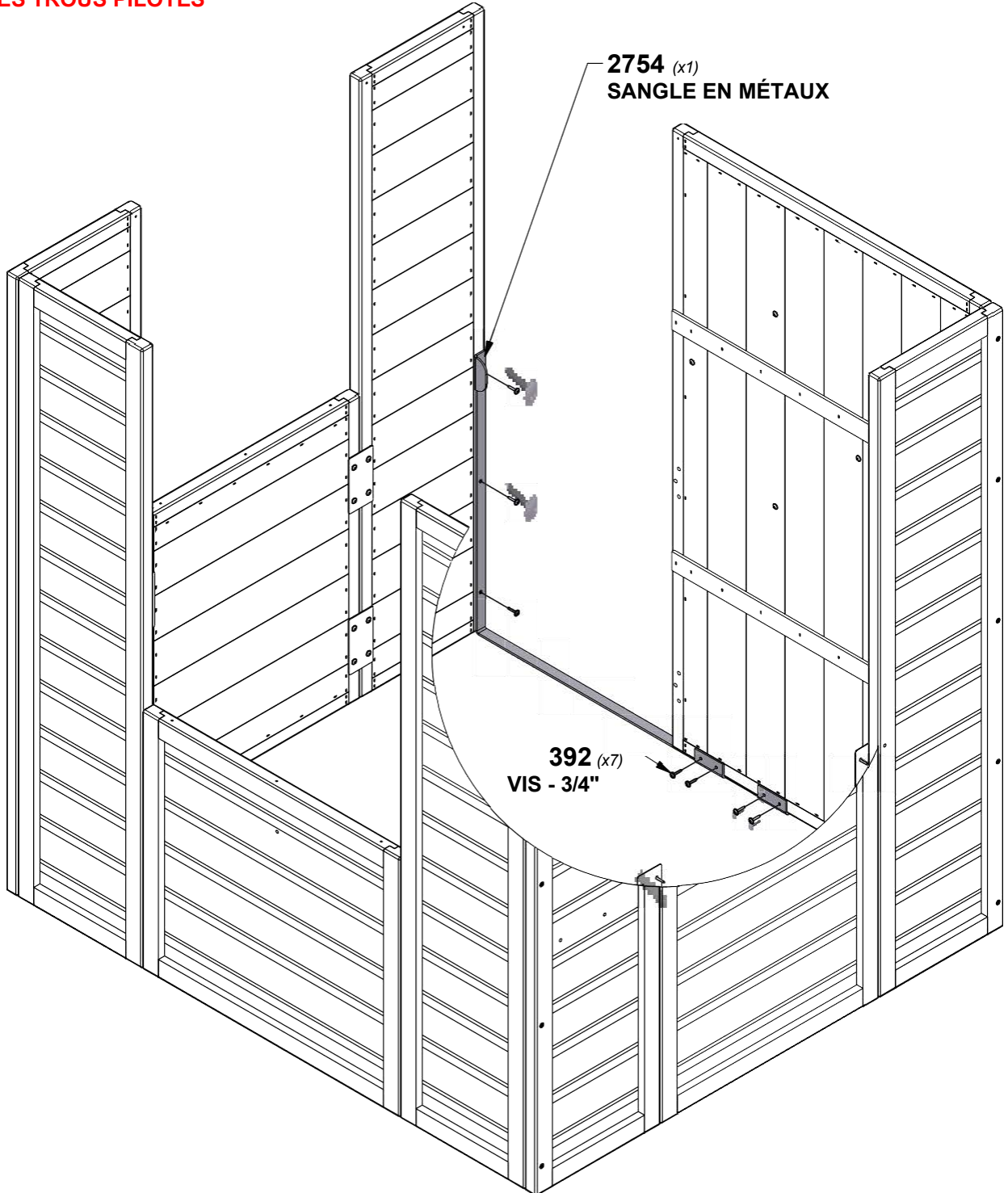

2754 (x1)
SANGLE EN MÉTAUX

392 (x7)
VIS - 3/4"

ÉTAPE 11 - ASSEMBLAGE DE CABANE

QTÉ	N° DE PIÈCES	DESCRIPTION
2	H100200	VIS PFH 8x1-1/2 BLK
4	H100387	VIS PFH 8x1-1/4 BLK

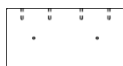

H01 (x2)SUPPORT DE PLATEAU DE TABLE - W4L19817
1"x3 3/8"x6 3/4" (24x86x172)

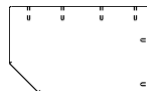

AD01 SUPPORT DE PLATEAU DE TABLE - W4L19818 (x1)
1"x4"x6 3/4" (24x102x172)

ASTUCE:
ALIGNEZ LES TROUS PILOTES

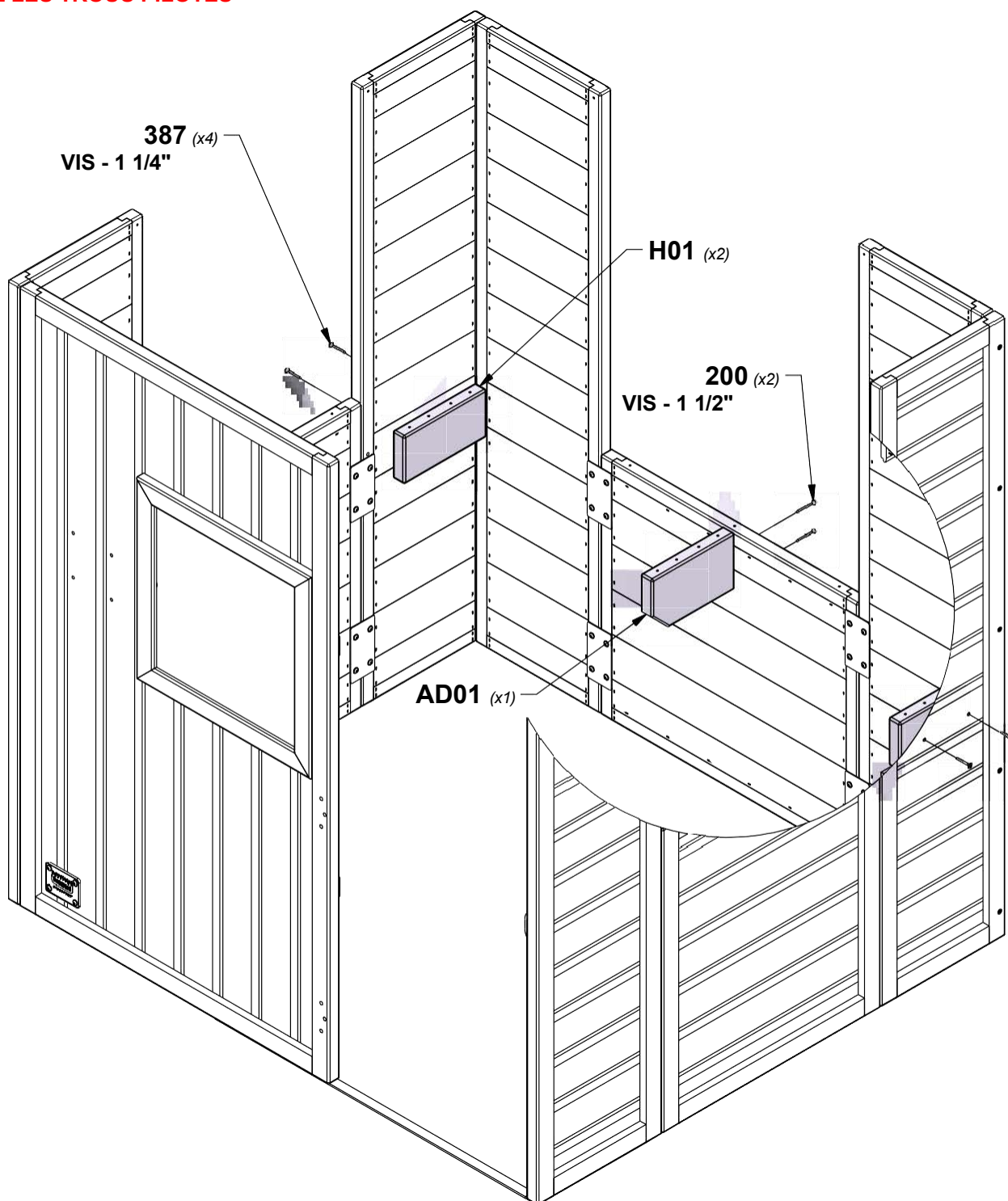

ÉTAPE 12 - ASSEMBLAGE DE CABANE

QTÉ	N° DE PIÈCES	DESCRIPTION
12	H100200	VIS PFH 8x1-1/2 BLK

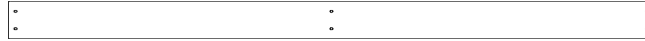

M02 PLATEAU DE TABLE - W4L19816
(x2) 5/8"x3 3/8"x41 5/8" (16x86x1056)

ASTUCE:
ALIGNEZ LES TROUS PILOTES

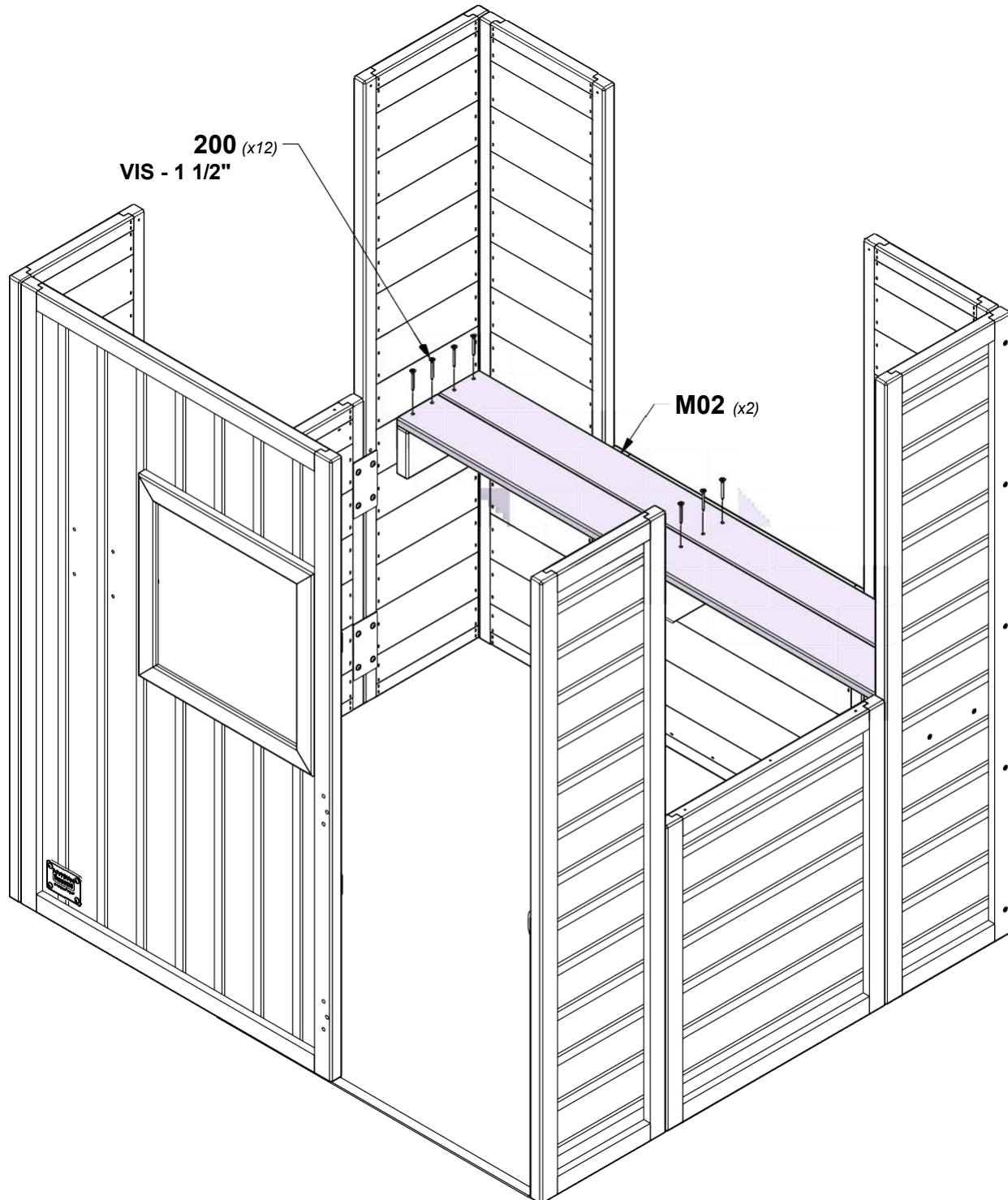

ÉTAPE 13 - ASSEMBLAGE DE CABANE

QTÉ	N° DE PIÈCES	DESCRIPTION
2	H100200	VIS PFH 8x1-1/2 BLK

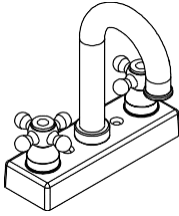

A6P00024
(x1) MONTAGE DE ROBINET

PLACEZ OÙ VOUS DÉSIREZ

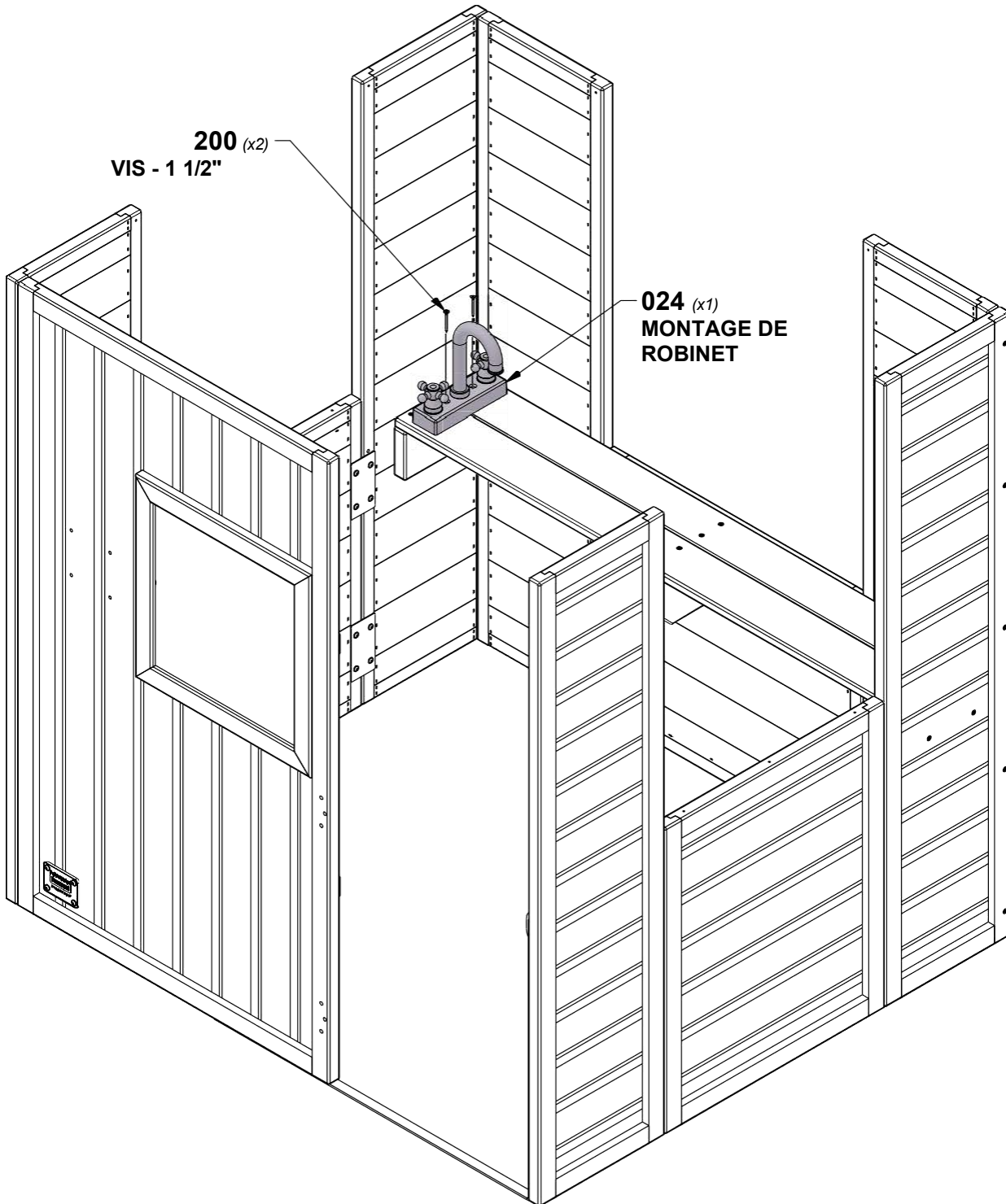

ÉTAPE 14 - ASSEMBLAGE DE CABANE

QTÉ	N° DE PIÈCES	DESCRIPTION
2	H100202	VIS PWH 8x5/8 BLK

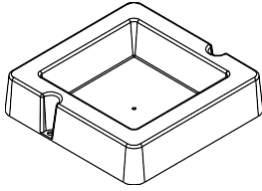

A6P00032 MONTAGE DE ÉVIER
(x1)

PLACEZ OÙ VOUS DÉSIREZ

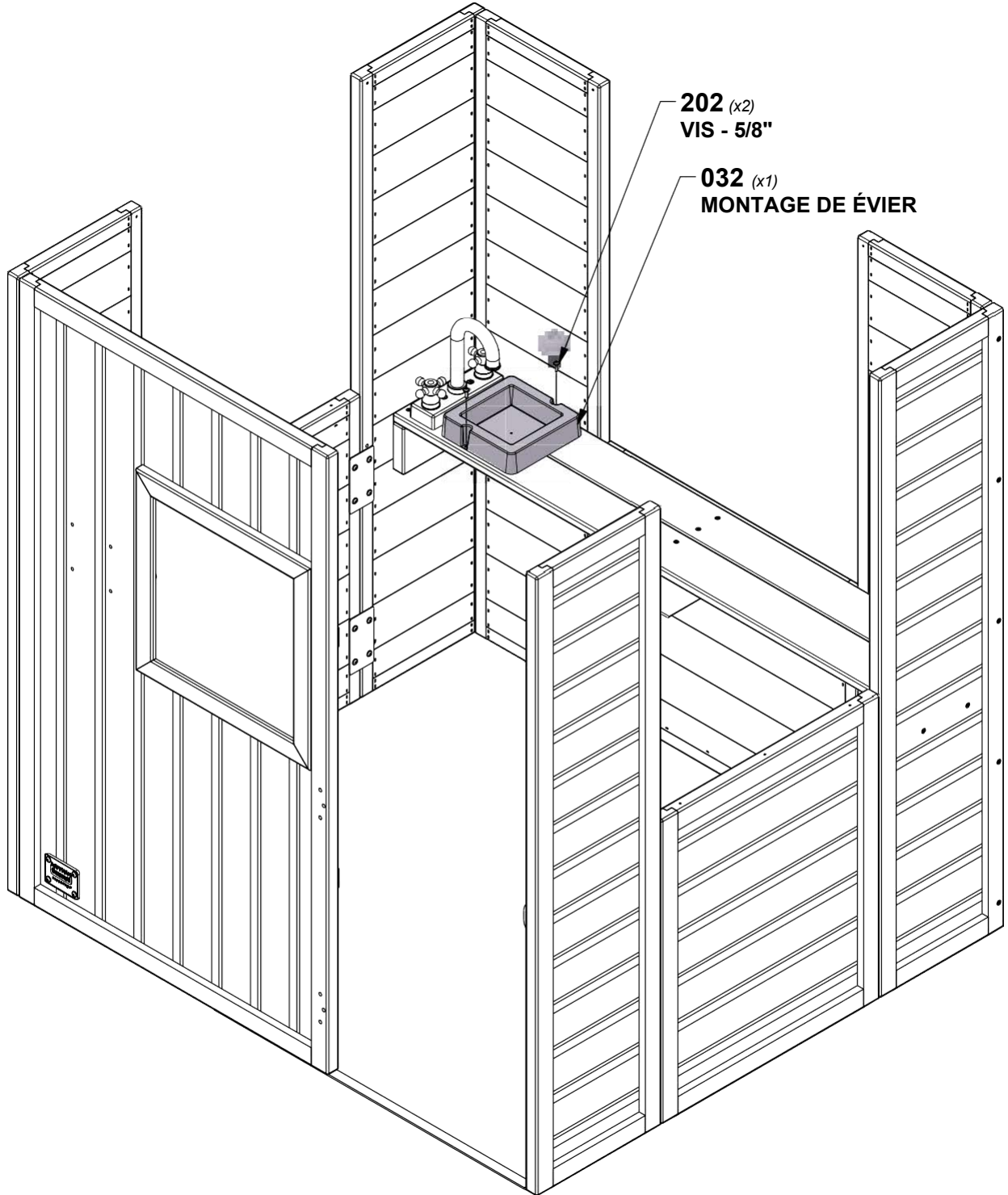

ÉTAPE 15 - ASSEMBLAGE DE CABANE

QTÉ	N° DE PIÈCES	DESCRIPTION
4	H100385	VIS PFH 8x1 BLK

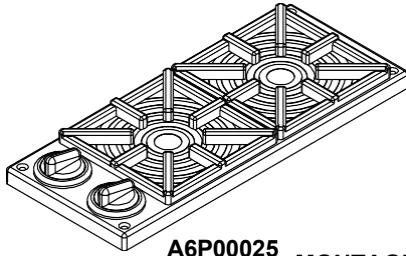

A6P00025
(x1) MONTAGE DE CUISINIÈRE

PLACEZ OÙ VOUS DÉSIREZ

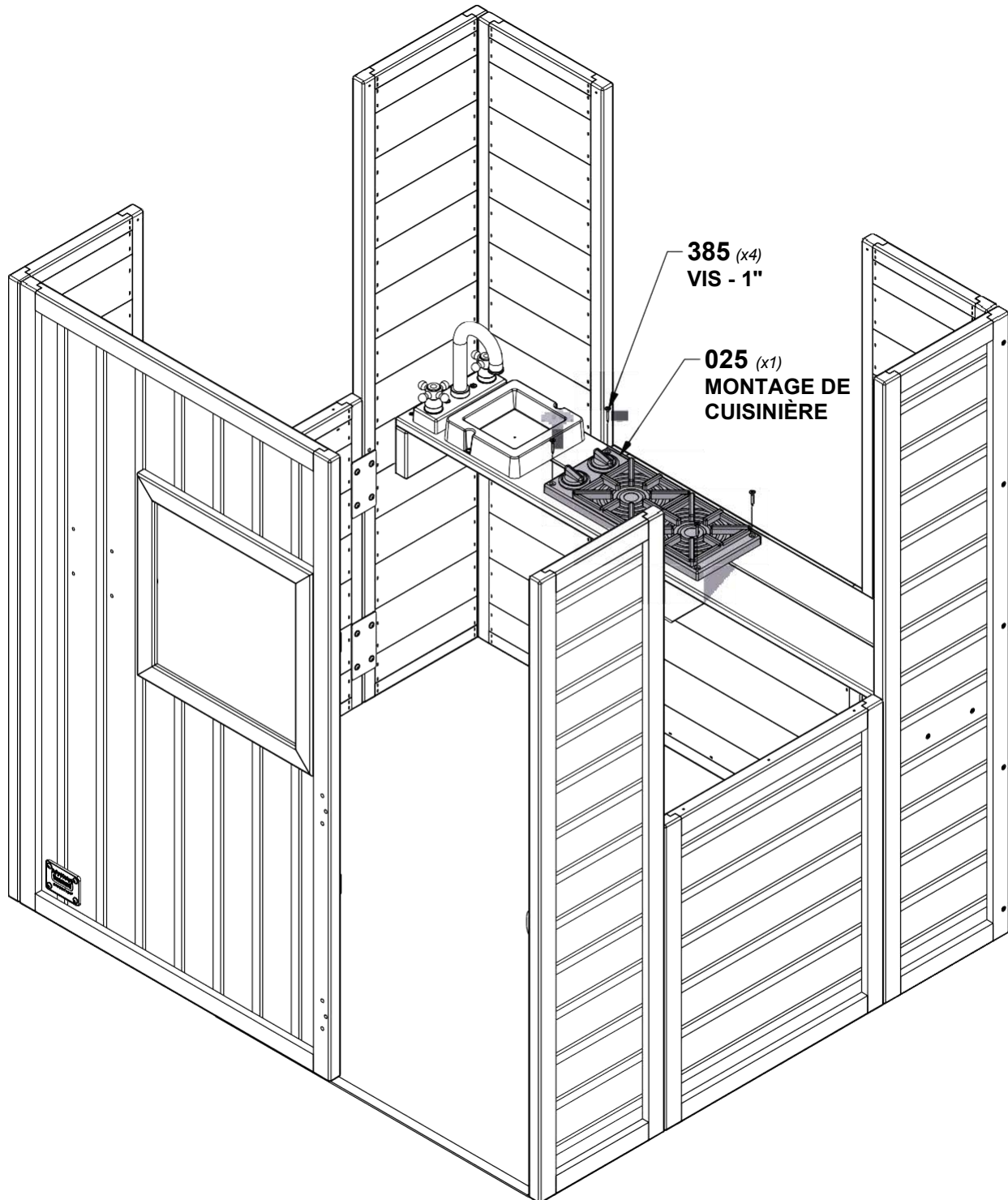

ÉTAPE 16 - ASSEMBLAGE DE CABANE

QTÉ	N° DE PIÈCES	DESCRIPTION
4	H100392	VIS PWH 8x3/4 BLK

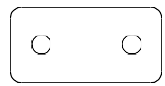

J01 RAIL HAUT - W4L19308
(x1) 1"x1 3/8"x41 5/8" (24x34x1057)

A4M02752 TRIQUET
(x2)

ASTUCE :
ALIGNER LES
TROUS PILOTES

2752 (x2)
TRIQUET

NOTEZ L'EMPLACEMENT
DES TROUS PILOTES

392 (x4)
VIS - 3/4"

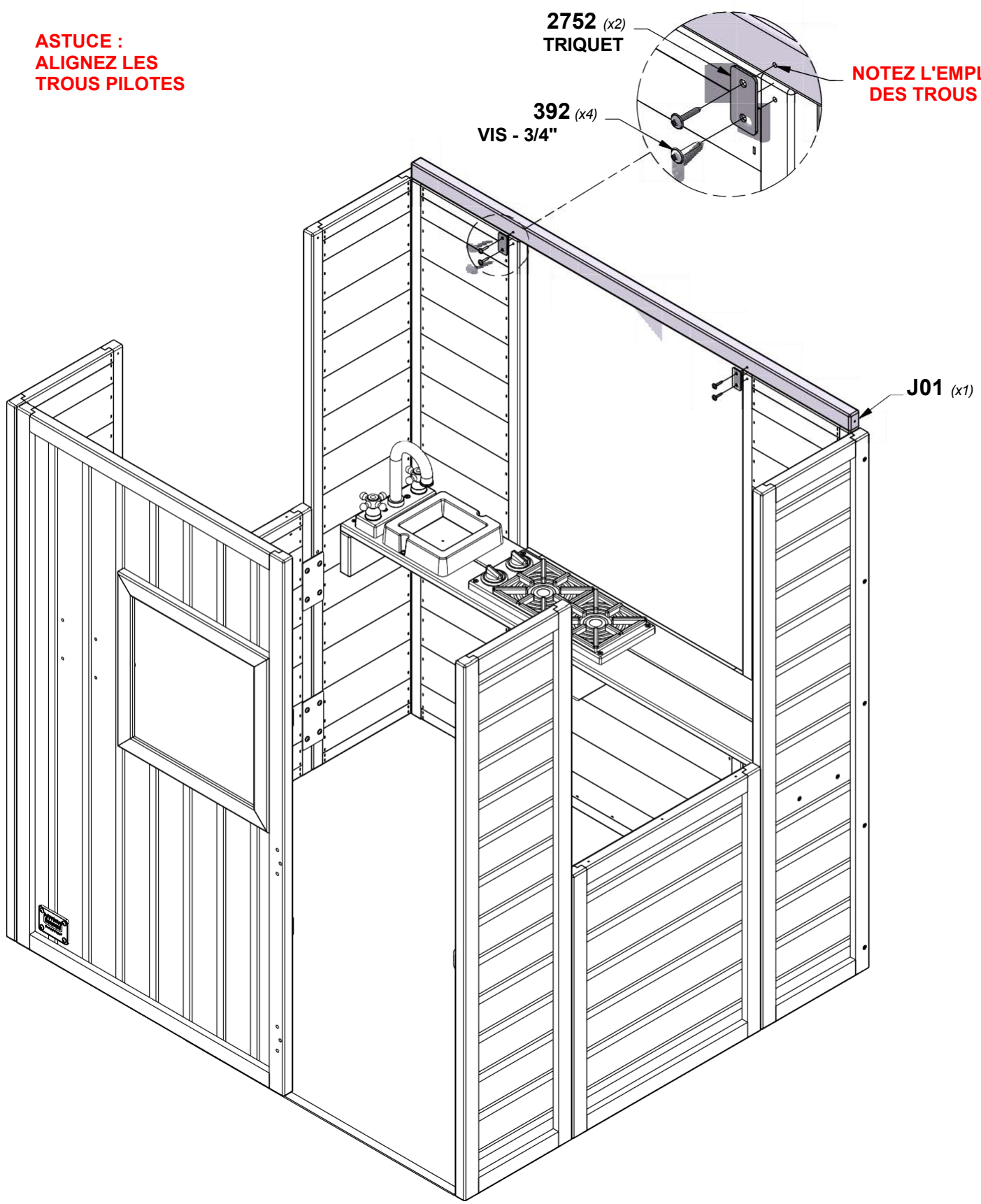

ÉTAPE 17 - ASSEMBLAGE DE CABANE

QTÉ	N° DE PIÈCES	DESCRIPTION
1	H100391	VIS PFH 8x2 BLK
4	H100392	VIS PWH 8x3/4 BLK

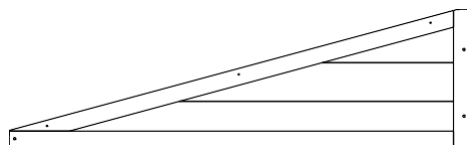

WP08 PANNEAU MURAUX -
(x1) **W2A04124**
1"x11 3/8"x38 3/8" (24x290x975)



A4M02752
(x2) **TRIQUET**

ASTUCE:
ALIGNEZ LES TROUS PILOTES

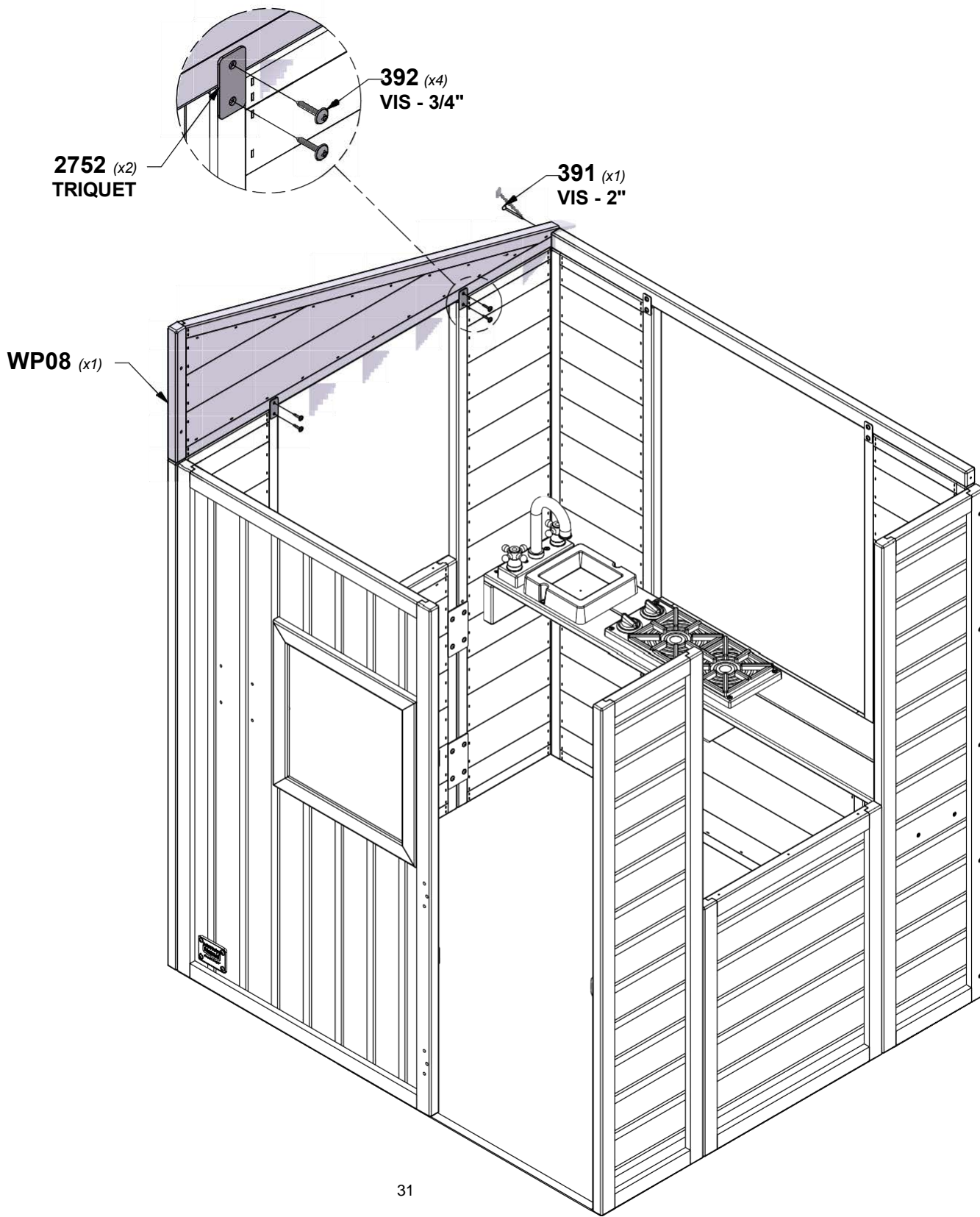

ÉTAPE 18 - ASSEMBLAGE DE CABANE

QTÉ	N° DE PIÈCES	DESCRIPTION
1	H100391	VIS PFH 8x2 BLK
6	H100392	VIS PWH 8x3/4 BLK

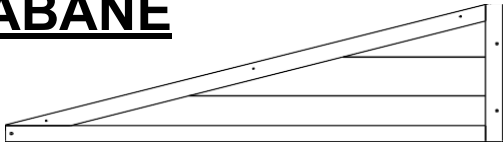

WP06 PANNEAU MURAUX -
(x1) **W2A04122**
1"x11 3/8"x38 3/8" (24x290x975)

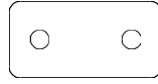

A4M02752
(x3) TRIQUET

ASTUCE:
ALIGNER LES TROUS PILOTES

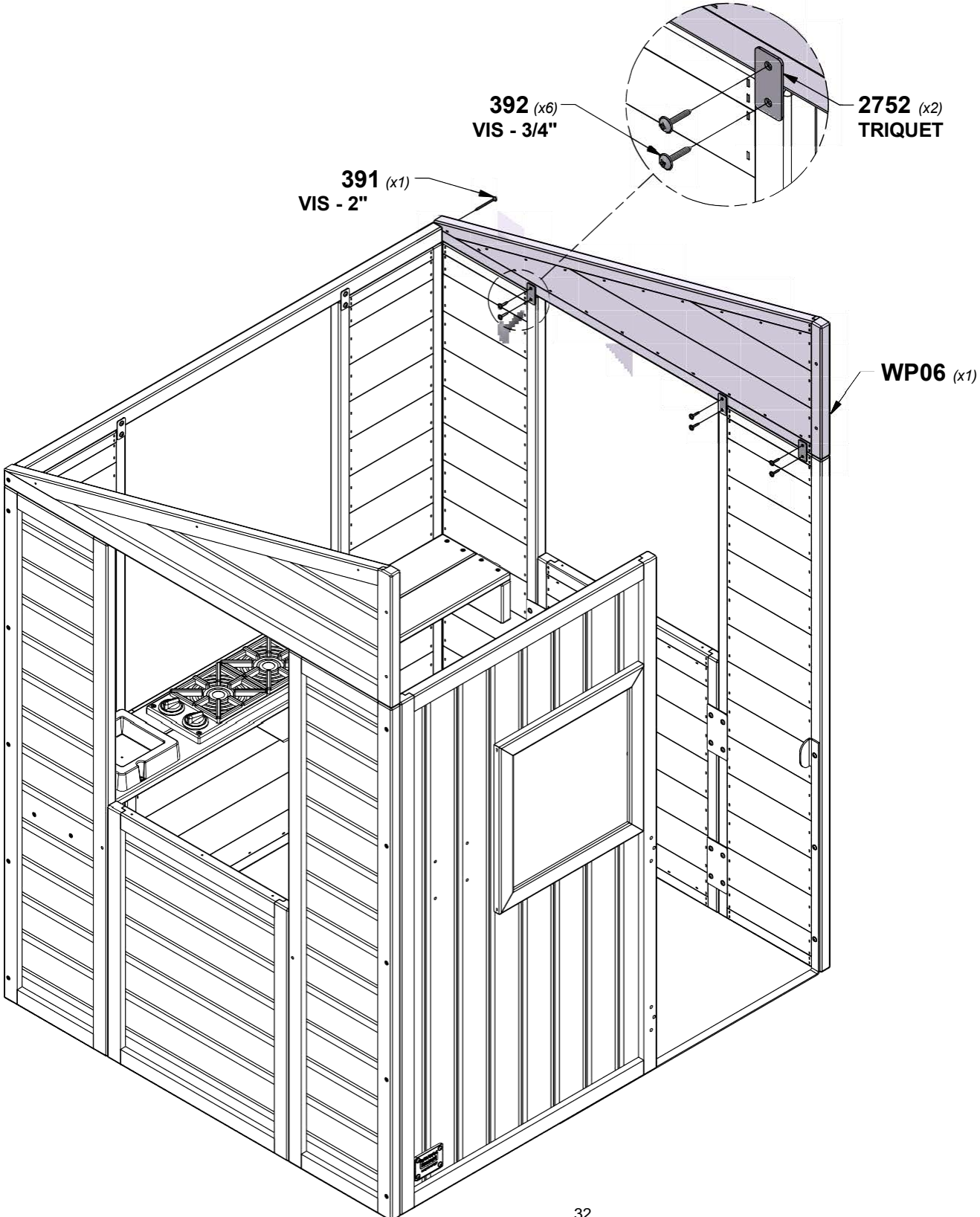

ÉTAPE 19 - ASSEMBLAGE DE CABANE

QTÉ	N° DE PIÈCES	DESCRIPTION
4	H100391	VIS PFH 8x2 BLK
2	H100392	VIS PWH 8x3/4 BLK

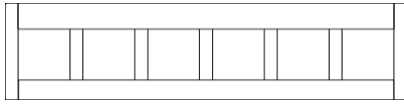

WP11 PANNEAU MURAUX - W2A04128
 (x1) 15/16"x11 7/16"x41 5/8" (24x290x1057)

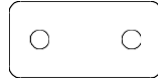

A4M02752 TRIQUET
 (x1)

ASTUCE:
ALIGNEZ LES TROUS PILOTES

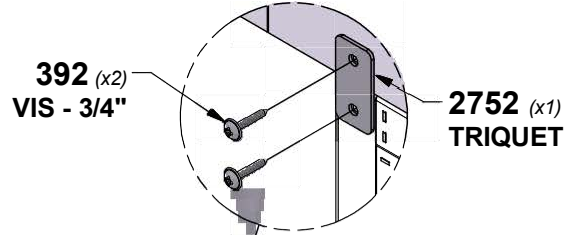

392 (x2)
VIS - 3/4"

2752 (x1)
TRIQUET

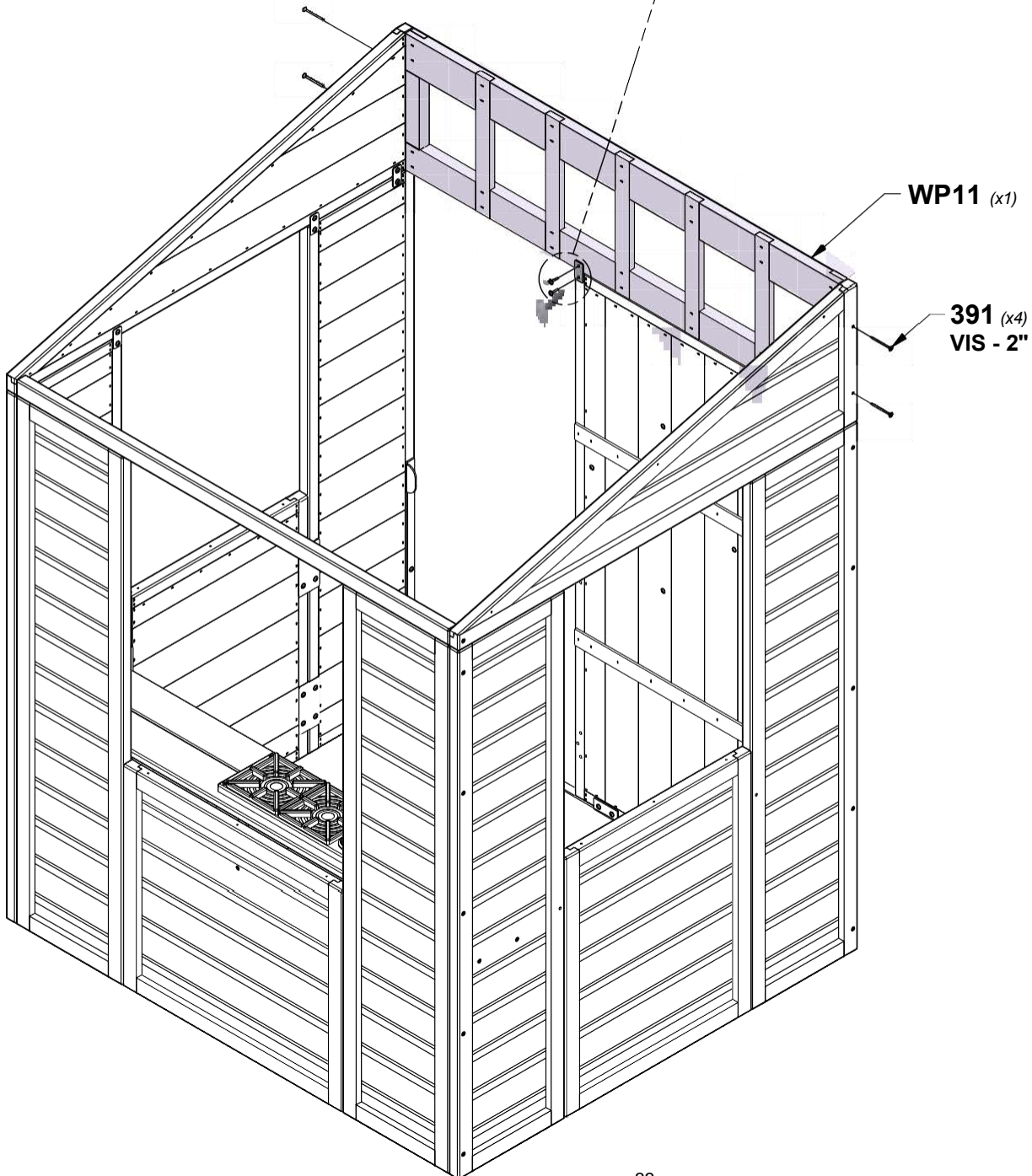

WP11 (x1)

391 (x4)
VIS - 2"

ÉTAPE 20 - ASSEMBLAGE DE CABANE

QTÉ	N° DE PIÈCES	DESCRIPTION
3	H100382	VIS PFH 8x1 3/4 BLK

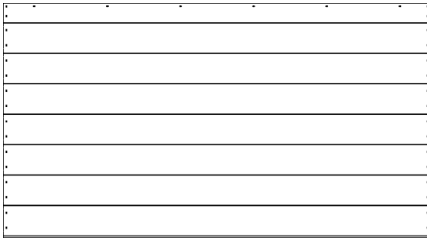

RP01 PANNEAU DE TOIT - W2A04130
(x1) 1 3/8"x24 5/8"x41 7/8" (35x625x1064)

ASTUCE:
ALIGNEZ LES TROUS PILOTES

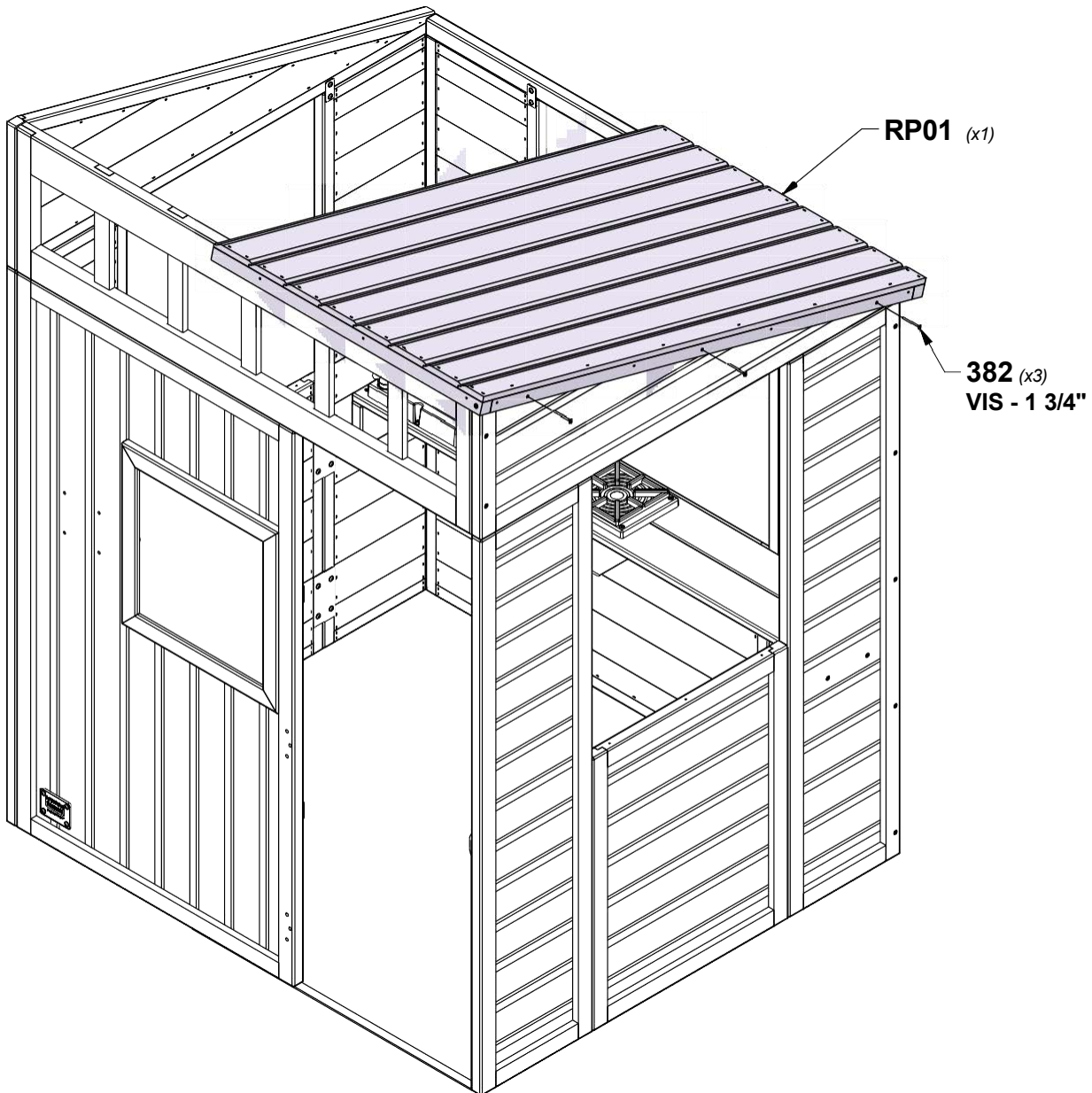

ÉTAPE 21 - ASSEMBLAGE DE CABANE

QTÉ	N° DE PIÈCES	DESCRIPTION
3	H100382	VIS PFH 8x1 3/4 BLK

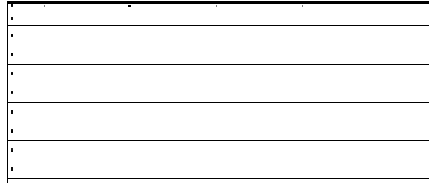

RP02
(x1)

PANNEAU DE TOIT - W2A04131
1 3/8"x21 1/8"x41 7/8" (35x535x1064)

ASTUCE:
ALIGNEZ LES TROUS PILOTES

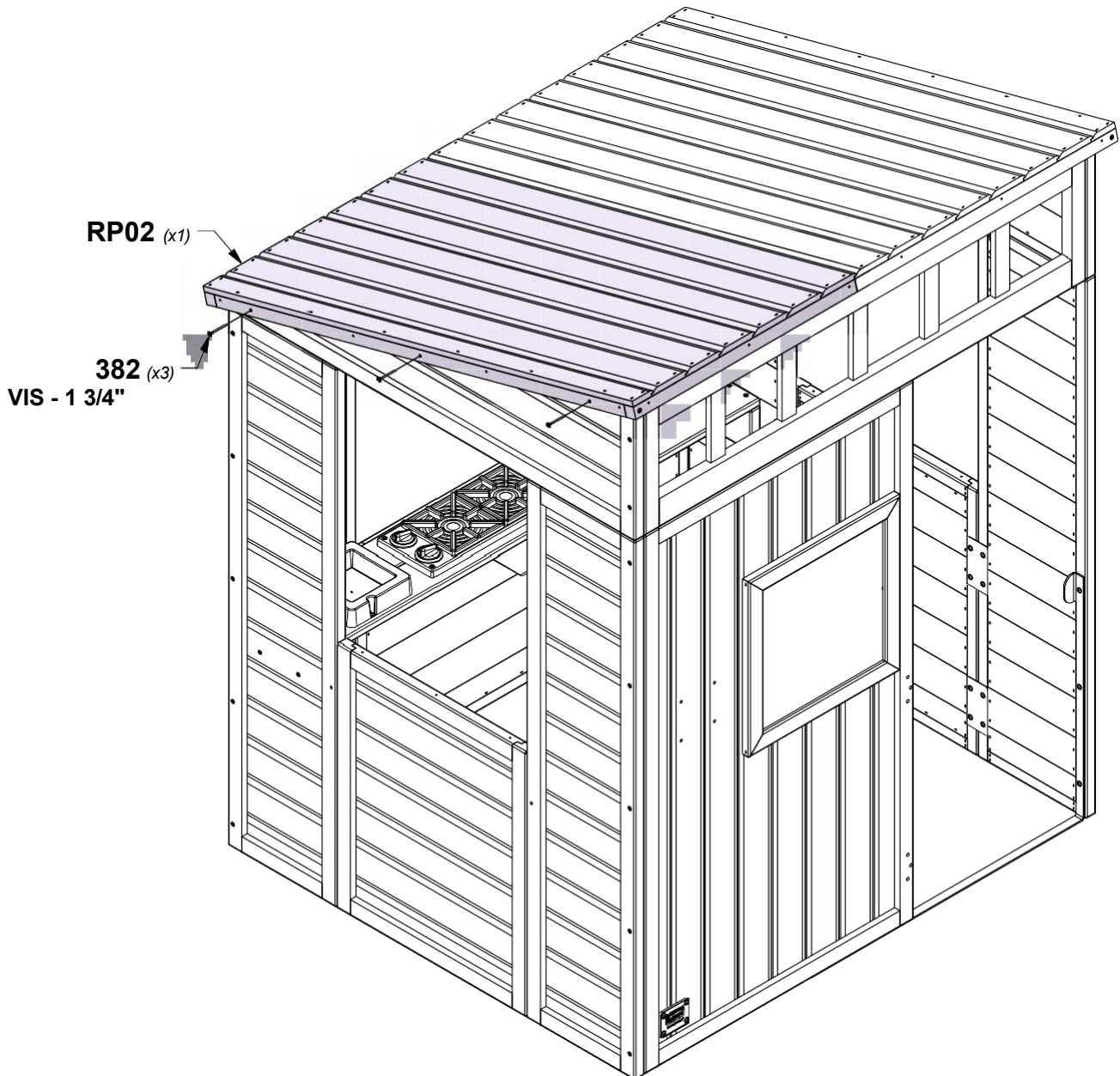

ÉTAPE 22 - ASSEMBLAGE DE CABANE

QTÉ	N° DE PIÈCES	DESCRIPTION
6	H100387	VIS PFH 8x1-1/4 BLK

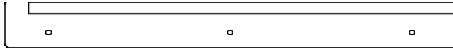

F03 GARNITURE DE TOIT -
(x1) **W4L19820**
1"x1 7/8"x18 7/8" (26x47x479)

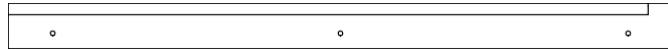

F02 GARNITURE DE TOIT - **W4L19316**
(x1) 1"x1 7/8"x27 1/2" (26x47x700)

ASTUCE:
ALIGNEZ LES TROUS PILOTES

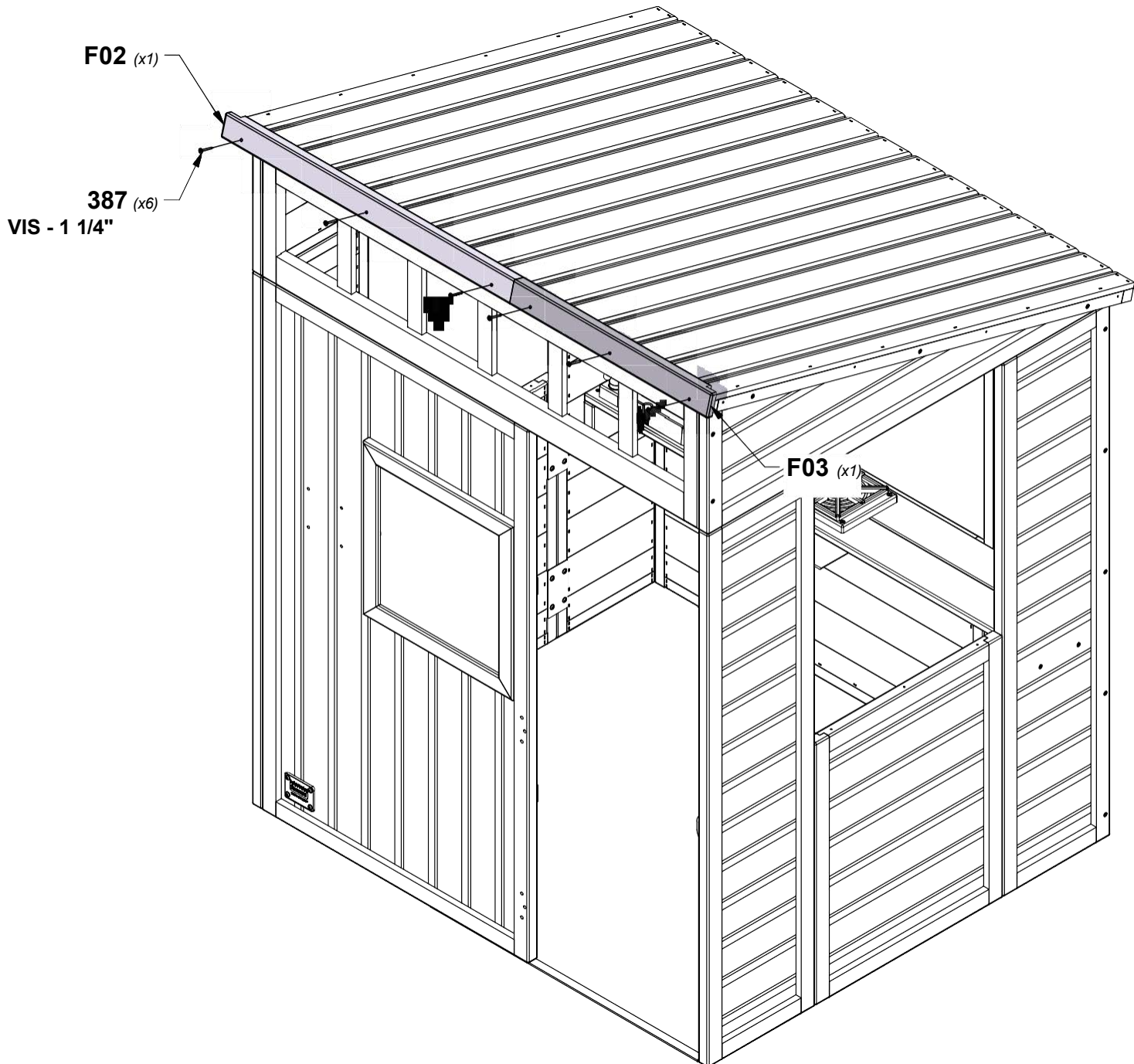

ÉTAPE 23 - ASSEMBLAGE DE CABANE

QTÉ	N° DE PIÈCES	DESCRIPTION
4	H100387	VIS PFH 8x1-1/4 BLK



F01 GARNITURE DE TOIT - W4L19315
(x1) 1"x1 7/8"x41 7/8" (26x47x1064)

ASTUCE:
ALIGNEZ LES TROUS PILOTES

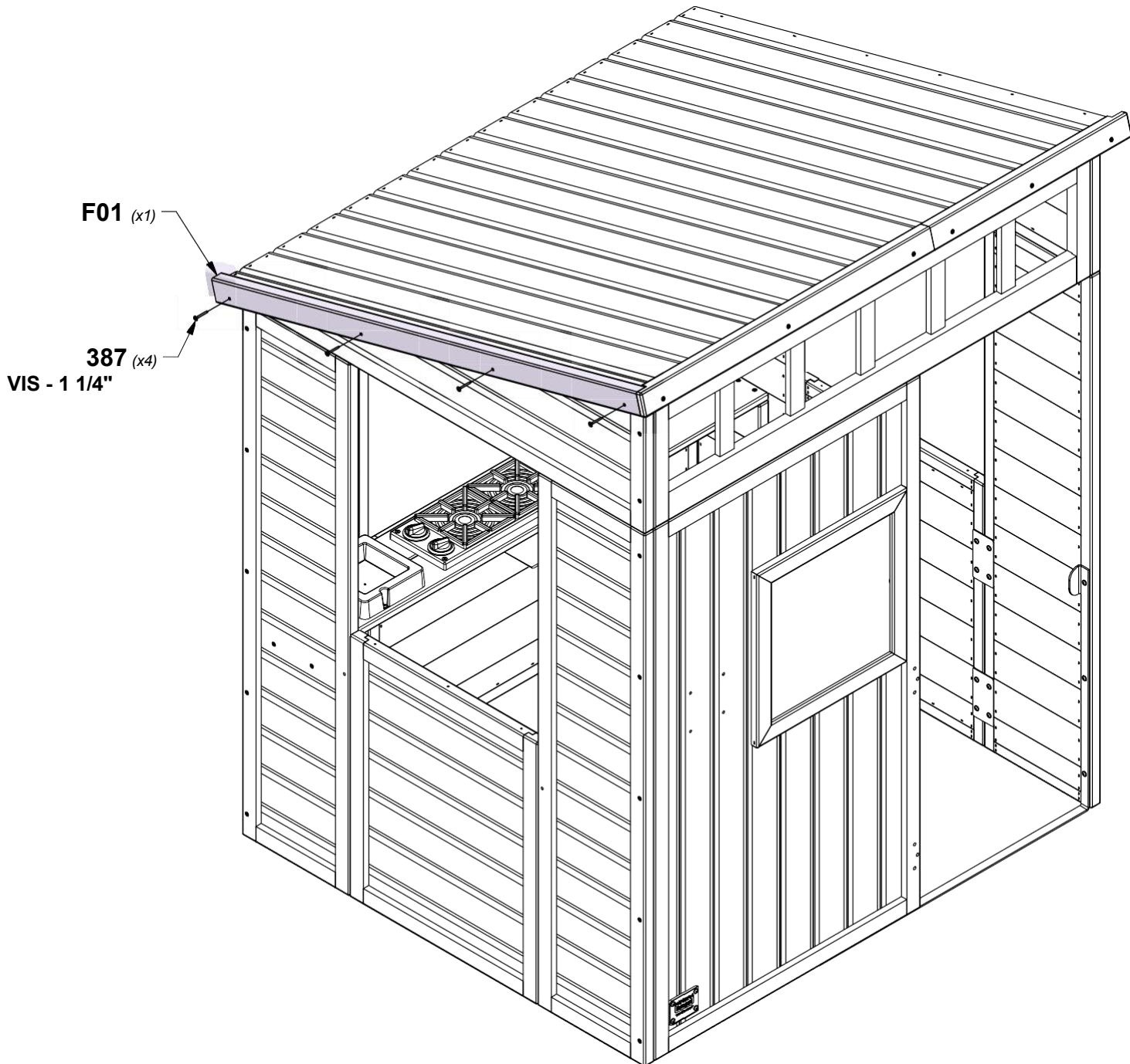

ÉTAPE 24 - ASSEMBLAGE DE CABANE

QTÉ	N° DE PIÈCES	DESCRIPTION
4	H100387	VIS PFH 8x1-1/4 BLK



F01 GARNITURE DE TOIT - W4L19315
(x1) 1"x1 7/8"x41 7/8" (26x47x1064)

ASTUCE:
ALIGNEZ LES TROUS PILOTES

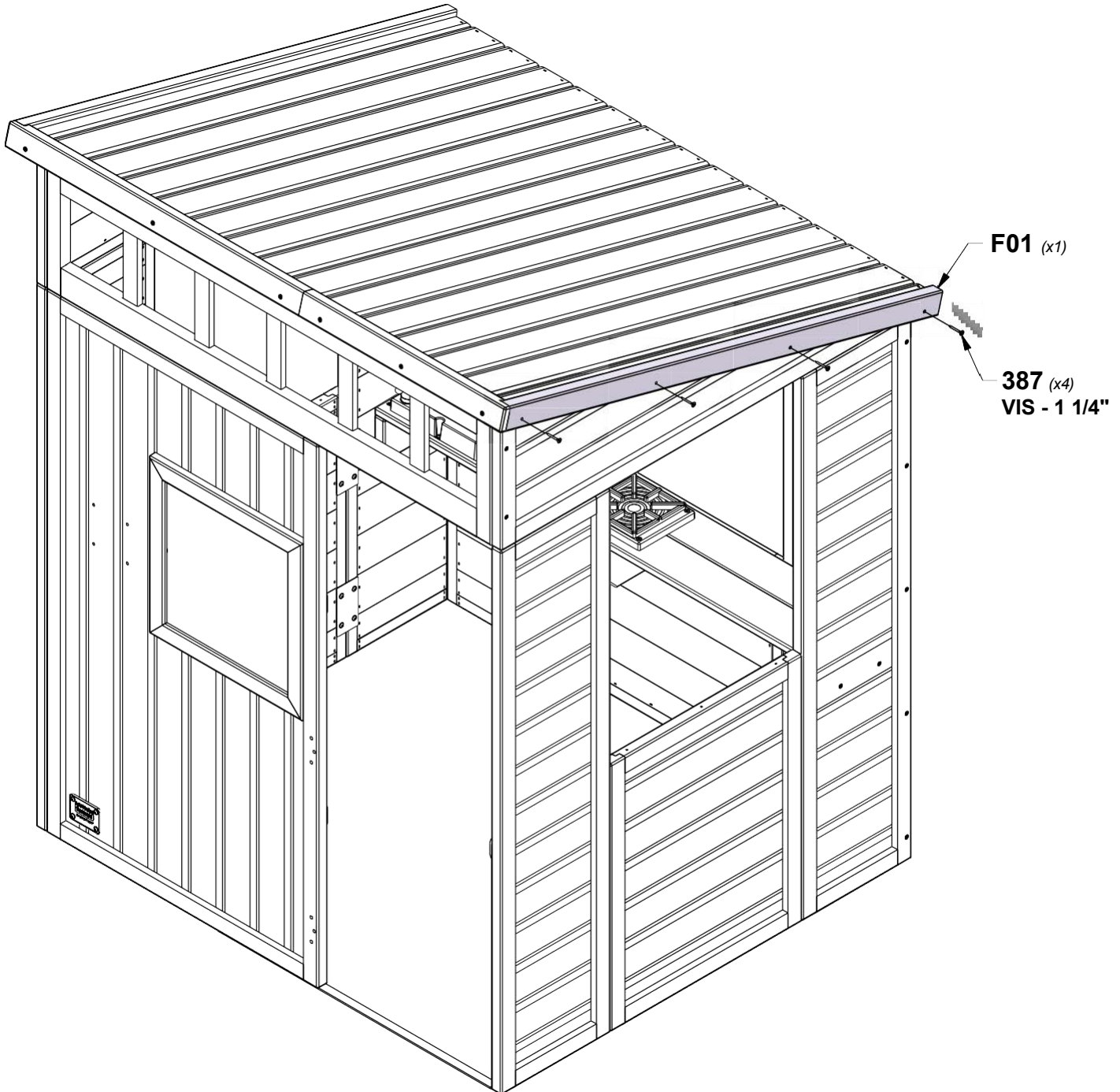

ÉTAPE 25 - ASSEMBLAGE DE CABANE

QTÉ	N° DE PIÈCES	DESCRIPTION
7	H100387	VIS PFH 8x1-1/4 BLK

N04 GARNITURE DE TOIT -
(x1) **W4L19819**
5/8"x1 3/8"x12 3/4" (16x34x324)

N03 GARNITURE DE TOIT - **W4L19317**
(x1) 5/8"x1 3/8"x33 5/8" (16x34x855)

ASTUCE:
ALIGNEZ LES TROUS PILOTES

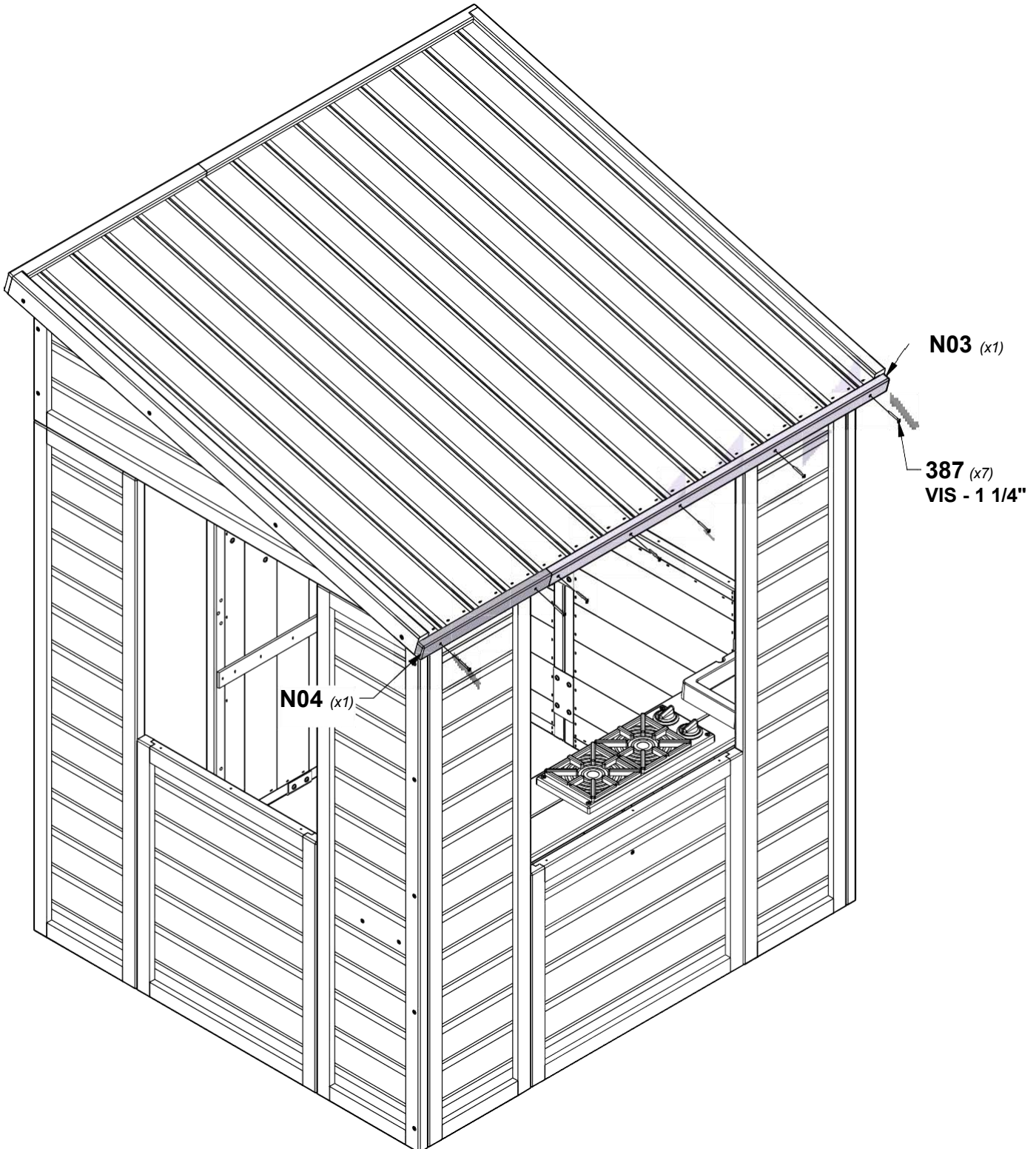

ÉTAPE 26 - ASSEMBLAGE DE CABANE

QTÉ	N° DE PIÈCES	DESCRIPTION
12	H100804	ÉCROU EN T 8/32
12	H100807	VIS POH-MS 8/32x1 BLK

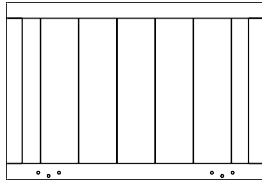

DP01
(x1)
PANNEAU DE LA PORTE - W2A04125
1"x10 1/4"x43 7/8" (24x374x548)



A4M00624
(x1)
GOND DE PORTE À RESSORT



A4M00994
(x1)
GOND DE PORTE

ASTUCE:
INSTALL ÉCROU EN TS IN WOOD FIRST

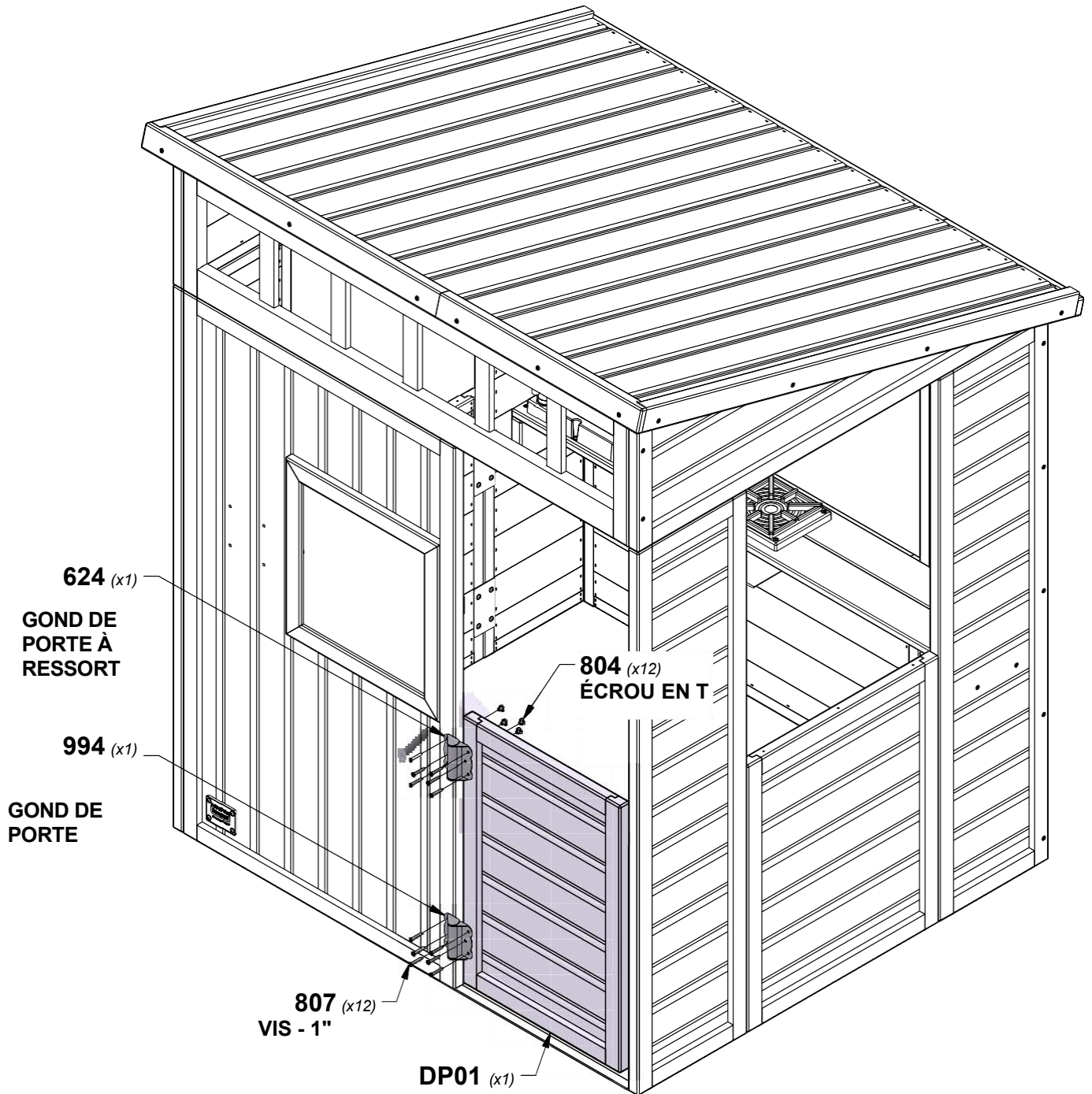

ÉTAPE 27 - ASSEMBLAGE DE CABANE

QTÉ	N° DE PIÈCES	DESCRIPTION
4	H100797	VIS PWH 8x1 BLK

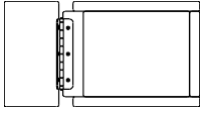

MB01 BOÎTE AUX LETTRES - W2A04129
(x1) 3 3/8"x6 9/16"x8 3/4" (86x166x222)

ASTUCE:
ALIGNEZ LES TROUS PILOTES

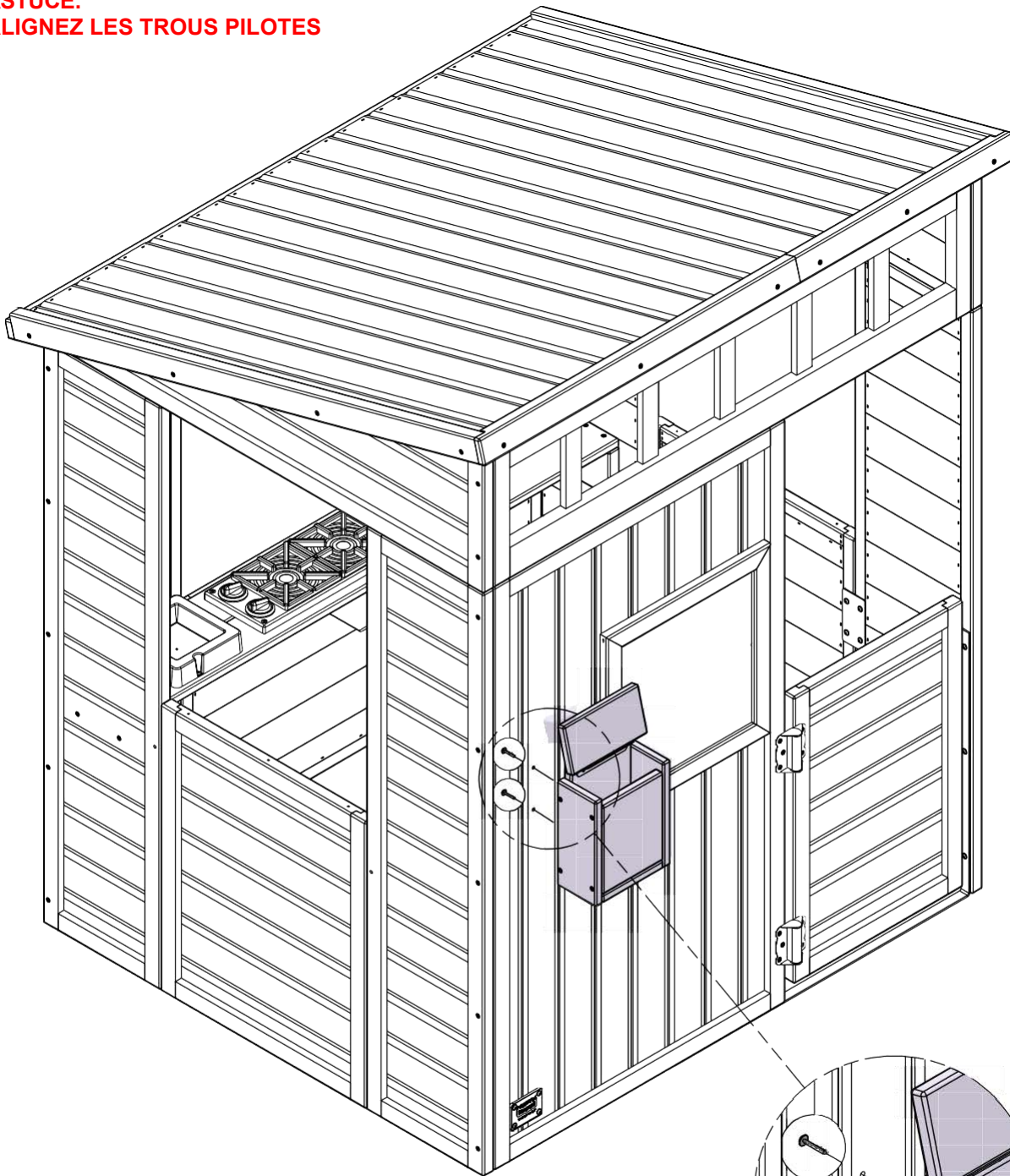

797 (x4)
VIS - 1"

MB01 (x1)

ÉTAPE 28 - ASSEMBLAGE DE CABANE

QTÉ	N° DE PIÈCES	DESCRIPTION
2	H100391	VIS PFH 8x2 BLK

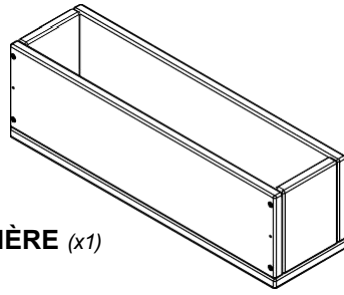

JARDINIÈRE (x1)

ASTUCE:
ALIGNEZ LES TROUS PILOTES

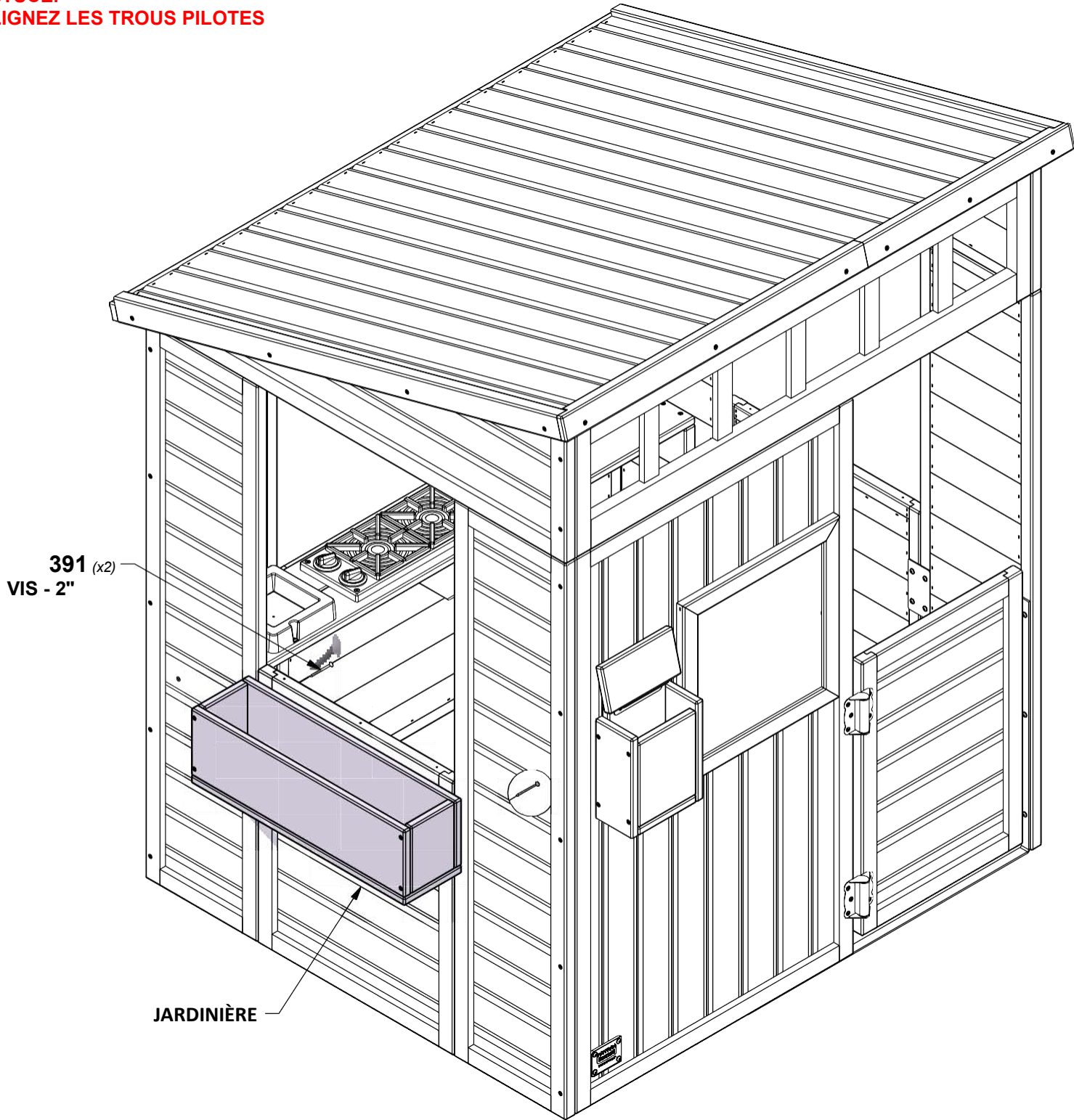

ÉTAPE 29 - ASSEMBLAGE DE CABANE

QTÉ	N° DE PIÈCES	DESCRIPTION
3	H100200	VIS PFH 8x1-1/2 BLK

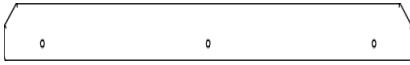

N02 PLANCHE DE FENÊTRE - W4L19310
(x1) 5/8"x1 5/8"x21 1/8" (16x40x536)

ASTUCE:
ALIGNEZ LES TROUS PILOTES

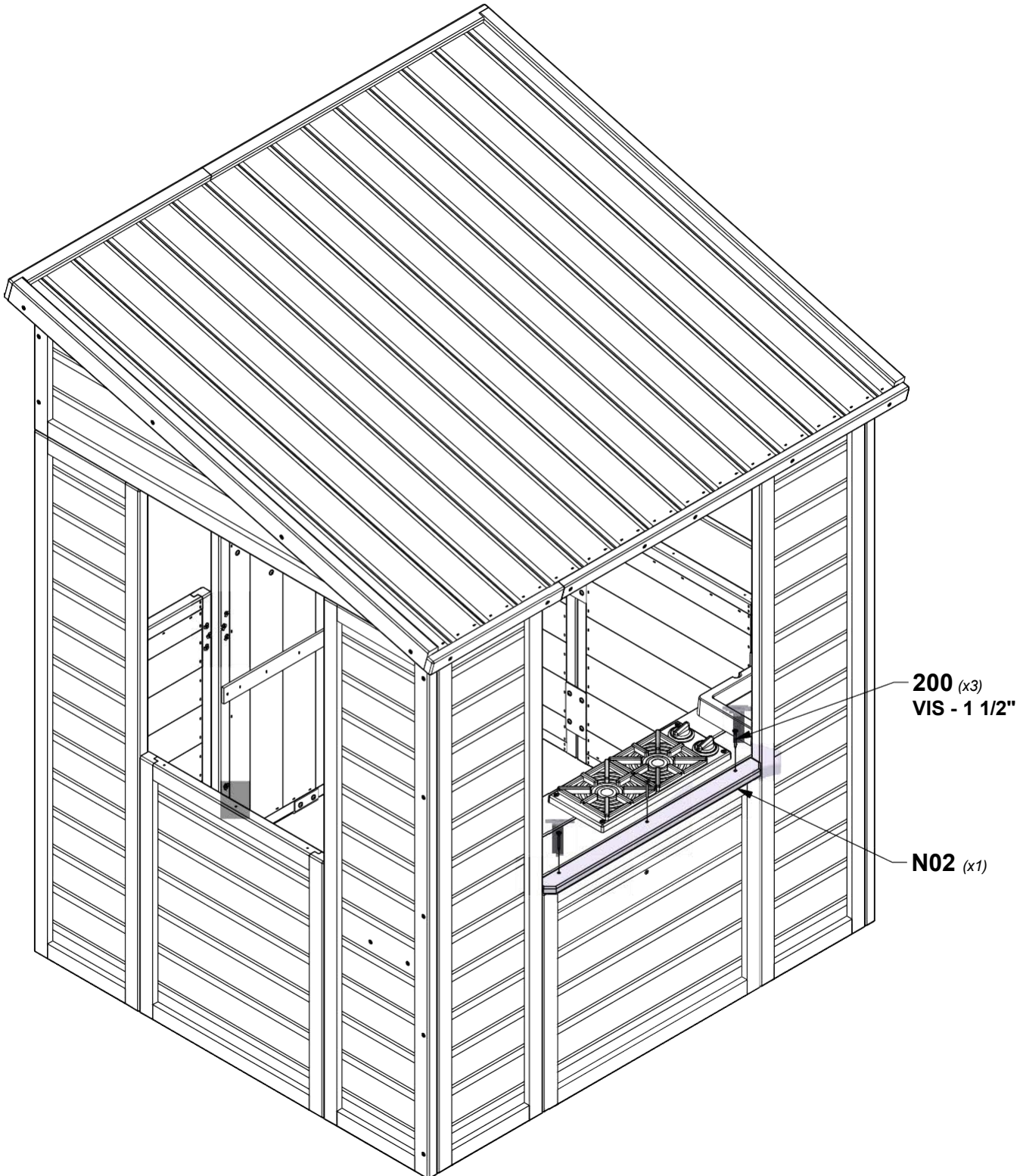

ÉTAPE 30 - ASSEMBLAGE DE CABANE

QTÉ	N° DE PIÈCES	DESCRIPTION
3	H100200	VIS PFH 8x1-1/2 BLK

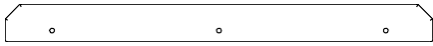

N01 PLANCHE DE FENÊTRE - W4L19309
(x1) 5/8"x1 5/8"x17 7/8" (16x40x454)

ASTUCE:
ALIGNEZ LES TROUS PILOTES

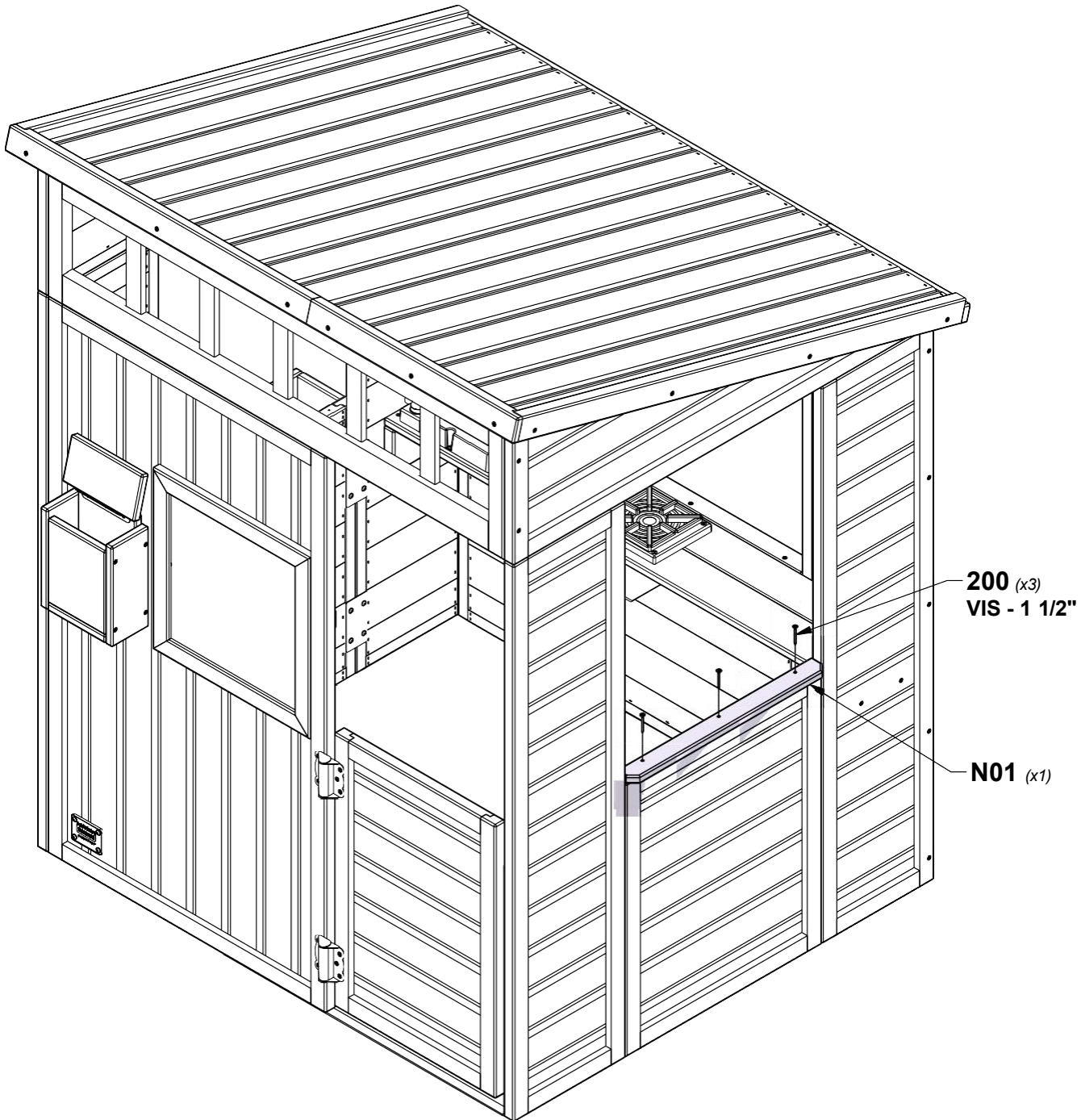

ÉTAPE 31 - ASSEMBLAGE DE CABANE

QTÉ	N° DE PIÈCES	DESCRIPTION
3	H100200	VIS PFH 8x1-1/2 BLK

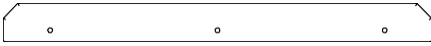

N01 PLANCHE DE FENÊTRE - W4L19309
(x1) 5/8"x1 5/8"x17 7/8" (16x40x454)

ASTUCE:
ALIGNEZ LES TROUS PILOTES

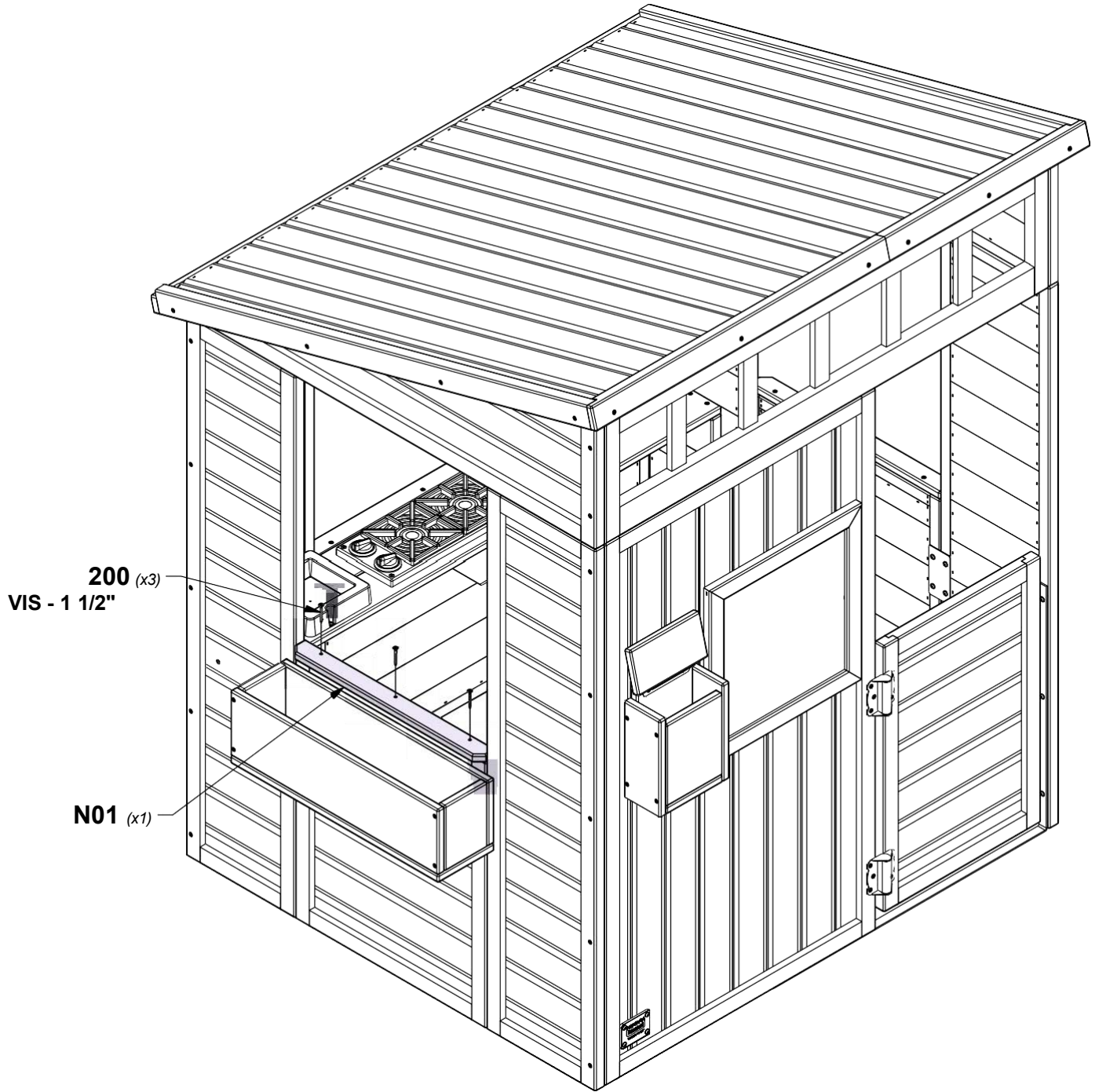

ÉTAPE 32 - ASSEMBLAGE DE CABANE

QTÉ	N° DE PIÈCES	DESCRIPTION
4	H100192	ÉCROU À BARILLET WH 5/16x7/8 BLK
4	H100199	RONDELLE D'ARRÊT EXT 12x19 BLK
4	H100396	BOULON WH 5/16x1/2 BLK



A4M00527 POTEAU DE FER À BÉTON
(x4)

NOTE: TAPEZ LES POTEAUX DE FER À BÉTON DANS LE SOL À UN ANGLE D'ENVIRON 45° AUX ENDROITS INDIQUÉS. EN UTILISANT LES POTEAUX COMME GUIDE, FOREZ LES TROUS À 10MM DE DIAMÈTRE POUR LA QUINCAILLERIE.

VUE DE L'HAUT

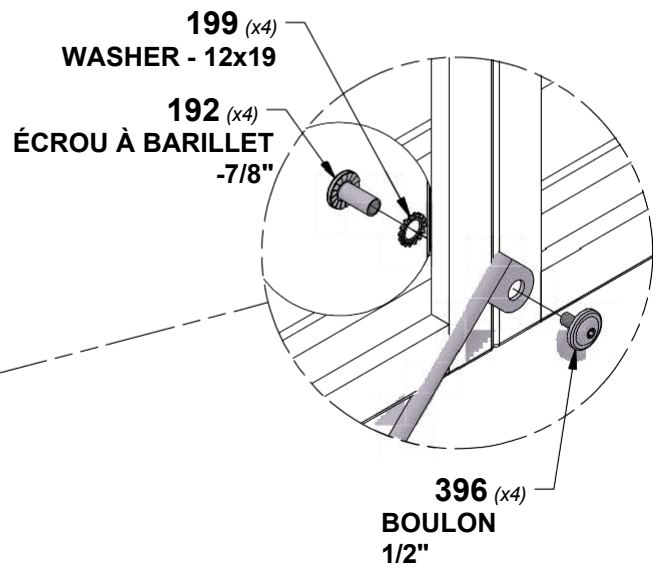
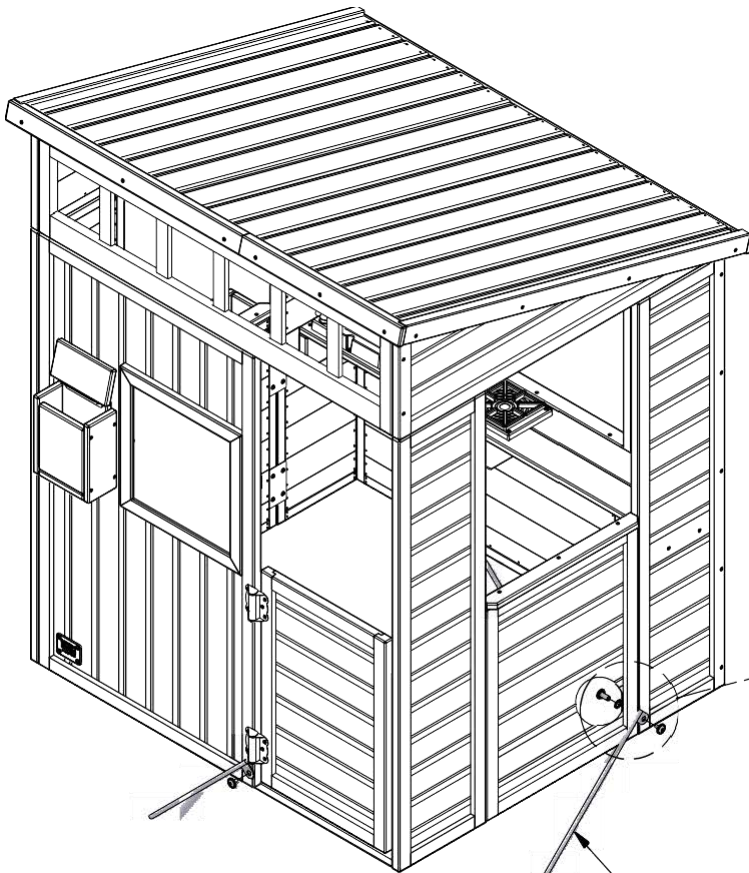
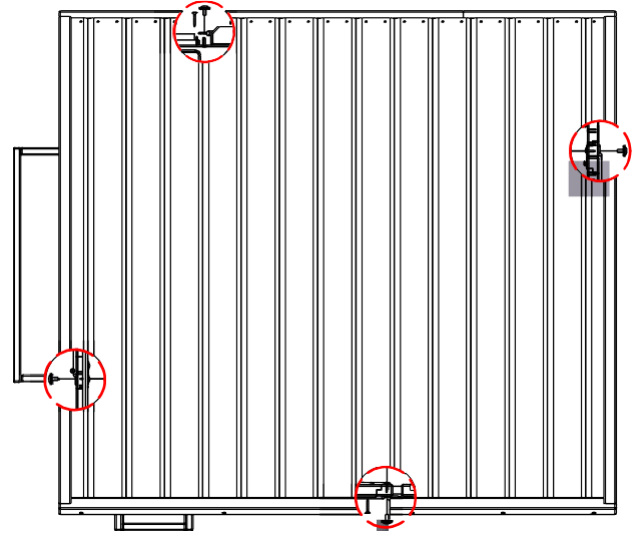

527 (x4)
POTEAU DE FER À BÉTON