



MANUFACTURED BY:
Backyard Discovery
3305 Airport Drive, Pittsburg, KS 66762
800-856-4445

Basepoint Business Centre: Rivermead Drive, Westlea, Swindon SN5 7EX Phone: 0800-118-2476
J.P. Coenstraat 7, The Bridge, The Hague, 2595 WP, Netherlands Phone: 0800-567-8990

CARAWAY COTTAGE - LT.BRN PLAYHOUSE

Model # 2303058

The assembly manual must be retained
since it contains important information



WARNING

Adult Assembly Required.

Not suitable for children under 36 months due to small parts.

FOR DOMESTIC USE ONLY. INTENDED FOR OUTDOOR USE.

CAN ICES-003 (B)/NMB-003(B)



Please visit www.backyarddiscovery.com

For the most up to date assembly manual, to register your set, or to order replacement parts

Para obtener instrucciones en español, visite www.backyarddiscovery.com

Made in China

INS-2303058-A-CARAWAY COTTAGE - LT.BRN-ENG 06/04/24

Owner's Manual - Basic Setup Dimensions & Assembly Notes

Selecting the correct location for your play product is important for your children's safety and the product's longevity

- The safe play area refers to a zone extending 6'-7" (2m) beyond the play product on all sides, including the space above the play product.

SAFE PLAY AREA DIAGRAM

Ground Dimension

3'-7 1/4" [1.1 m] x 4'-2 1/4" [1.3 m]

Safe Play Area

16'-9 1/4" [5.1 m] x 17'-4 1/4" [5.3 m] x 11'-4" [3.5 m]

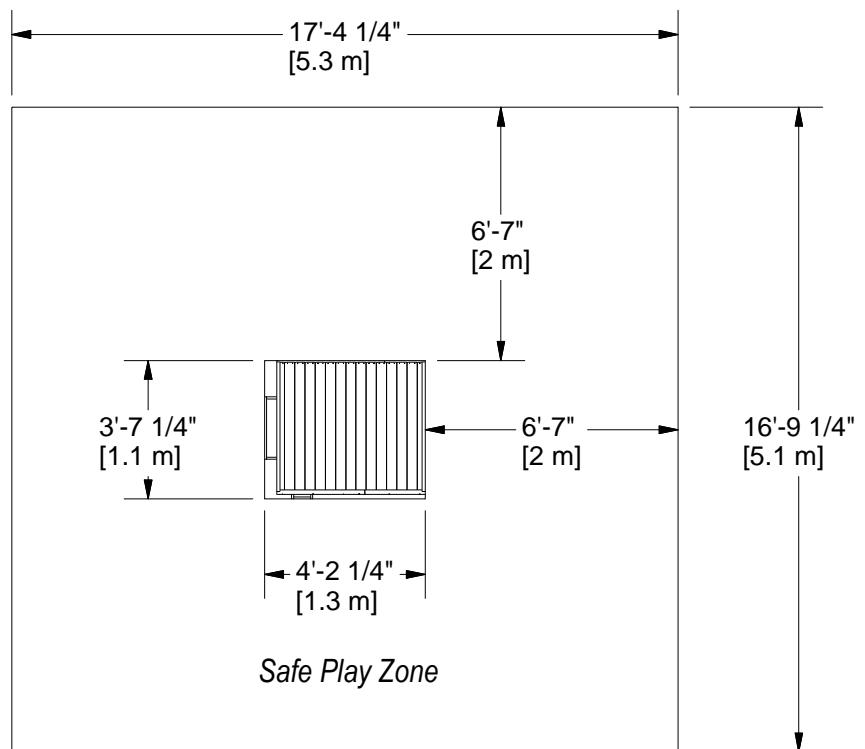

SAFE PLAY HEIGHT: 11'-4" [3.5m]
MAXIMUM FALL HEIGHT: 1'-10 3/4" [.6m]

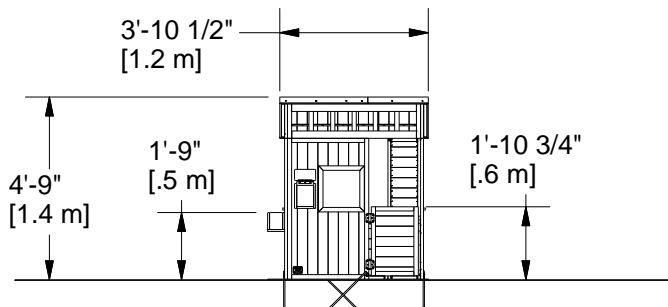

General Information:

Your set has been designed and engineered for children only and for residential use only.
A maximum of 150 lbs. per child is recommended for play activities designed for individual use.
A maximum of 120 lbs. per child is recommended for play activities designed for multiple child use.
A maximum of 6 children is recommended for this playhouse.

Owner's Manual - Parts Identification

Wood Components (Not to Scale)

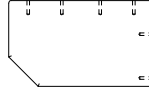

AD01 TABLE TOP SUPPORT - W4L19818

(x1) 1"x4"x6 3/4" (24x102x172)



F01 ROOF TRIM - W4L19315

(x2) 1"x1 7/8"x41 7/8" (26x47x1064)

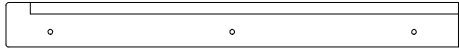

F03 ROOF TRIM - W4L19820

(x1) 1"x1 7/8"x18 7/8" (26x47x479)

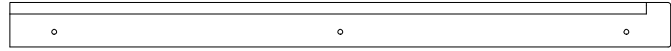

F02 ROOF TRIM - W4L19316

(x1) 1"x1 7/8"x27 1/2" (26x47x700)

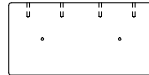

H01 TABLE TOP SUPPORT - W4L19817

(x2) 1"x3 3/8"x6 3/4" (24x86x172)



J01 TOP RAIL - W4L19821

(x1) 1"x1 3/8"x41 5/8" (24x34x1057)

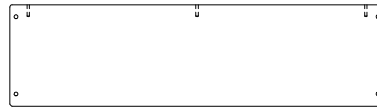

K01 FRONT - W4L19822

(x1) 5/8"x5 1/4"x19 1/2" (16x134x495)

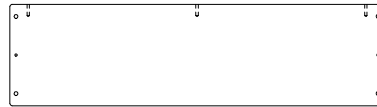

K02 BACK - W4L19823

(x1) 5/8"x5 1/4"x19 1/2" (16x134x495)



K03 BOTTOM - W4L19825

(x1) 5/8"x5 1/4"x19 1/2" (16x134x495)

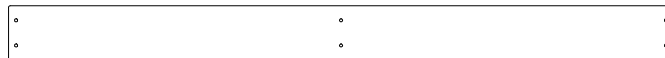

M02 TABLE TOP - W4L19816

(x2) 5/8"x3 3/8"x41 5/8" (16x86x1056)

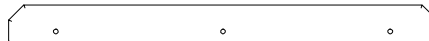

N01 WINDOW BOARD - W4L19309

(x2) 5/8"x1 5/8"x17 7/8" (16x40x454)

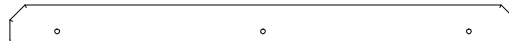

N02 WINDOW BOARD - W4L19310

(x1) 5/8"x1 5/8"x21 1/8" (16x40x536)



N04 ROOF TRIM - W4L19819

(x1) 5/8"x1 3/8"x12 3/4" (16x34x324)



N03 ROOF TRIM - W4L19317

(x1) 5/8"x1 3/8"x33 5/8" (16x34x855)

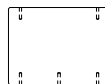

Y01 SIDE - W4L19824

(x2) 5/8"x4"x5 1/4" (16x102x134)

Owner's Manual - Parts Identification

Wood Components (Not to Scale)

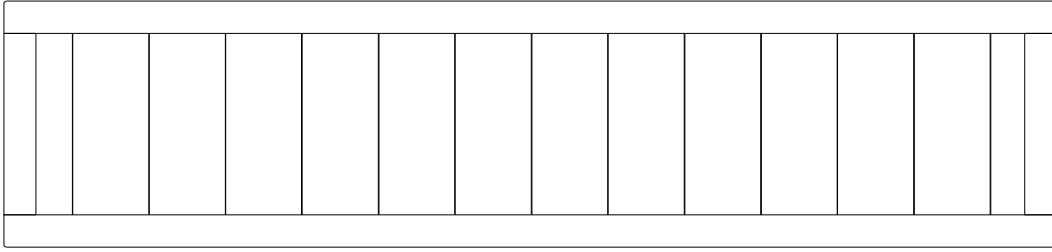

WP01 WALL PANEL - W2A04140
(x1) 1"x10 1/4"x43 7/8" (24x260x1115)

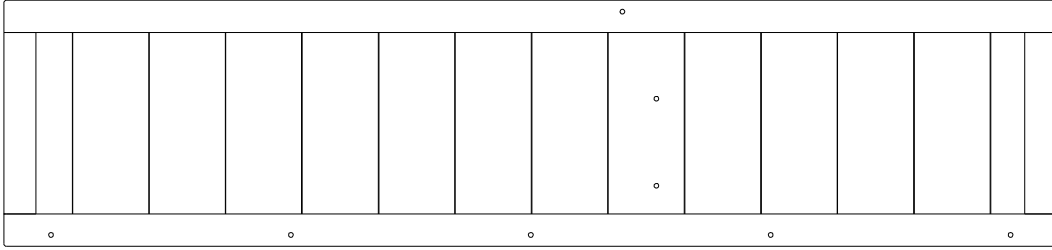

WP02 WALL PANEL - W2A04141
(x1) 1"x10 1/4"x43 7/8" (24x260x1115)

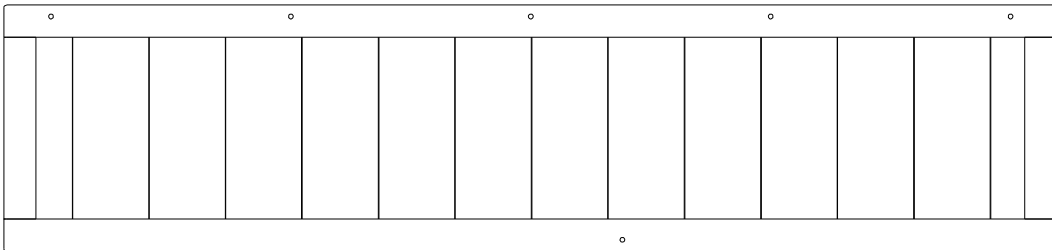

WP03 WALL PANEL - W2A04142
(x1) 1"x10 1/4"x43 7/8" (24x260x1115)

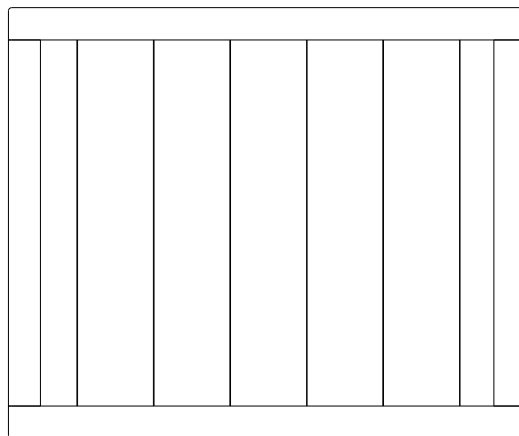

WP04 WALL PANEL - W2A04143
(x2) 1"x10 1/4"x43 7/8" (24x455x548)

Owner's Manual - Parts Identification

Wood Components (Not to Scale)

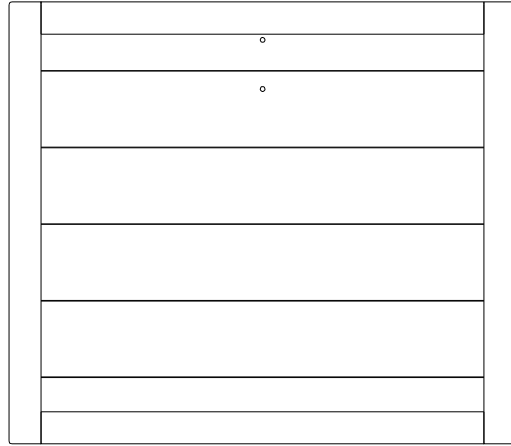

WP05 WALL PANEL - W2A04144
(x1) 1"x18 3/8"x21 1/8" (24x467x537)

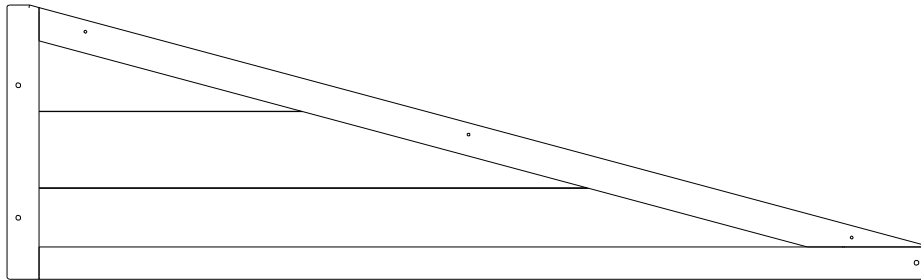

WP06 WALL PANEL - W2A04145
(x1) 1"x11 3/8"x38 3/8" (24x290x975)

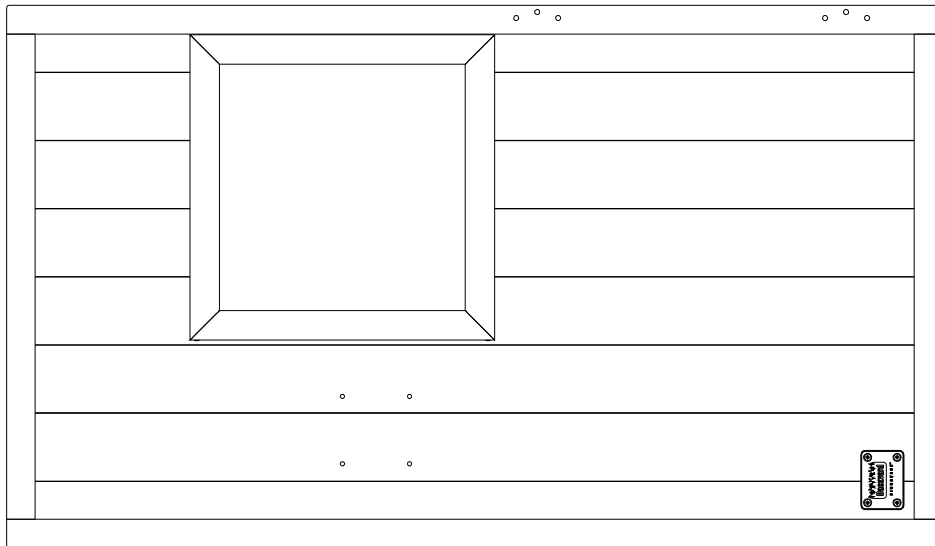

WP07 WALL PANEL - W2A04146
(x1) 1"x10 1/4"x43 7/8" (24x645x1115)

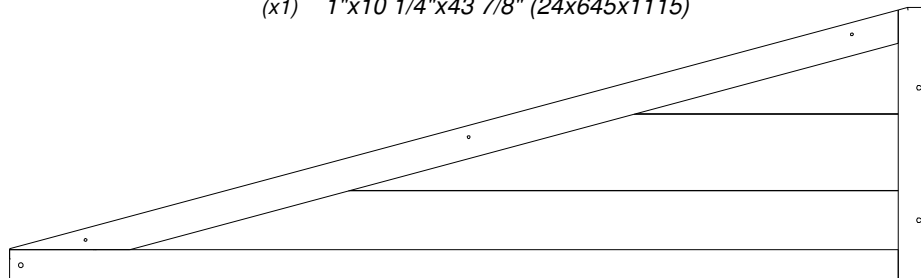

WP08 WALL PANEL - W2A04147
(x1) 1"x11 3/8"x38 3/8" (24x290x975)

Owner's Manual - Parts Identification

Wood Components (Not to Scale)

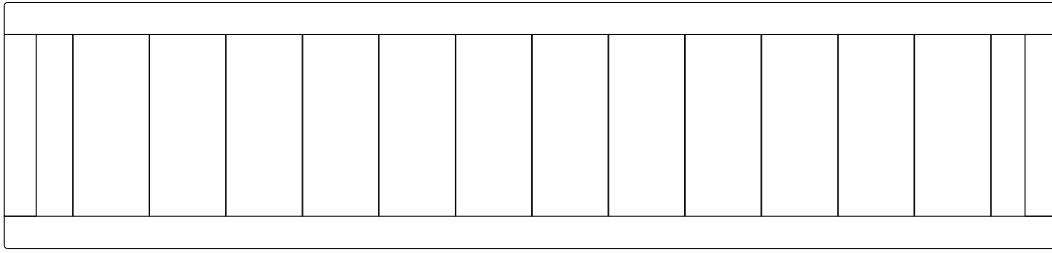

WP09 WALL PANEL - W2A04149
(x1) 1"x10 1/4"x43 7/8" (24x260x1115)

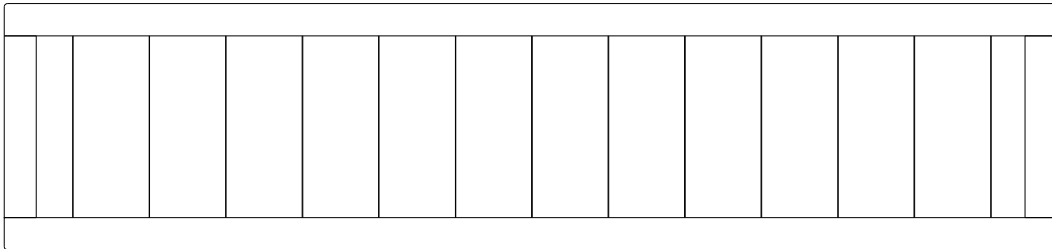

WP10 WALL PANEL - W2A04221
(x1) 1"x10 1/4"x43 7/8" (24x260x1115)

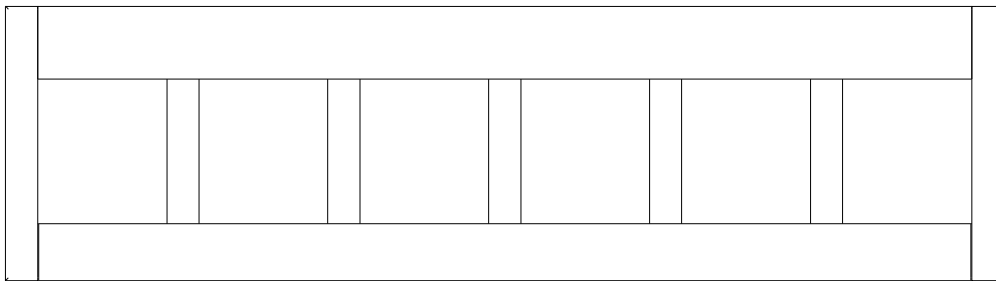

WP11 WALL PANEL - W2A04222
(x1) 15/16"x11 7/16"x41 5/8" (24x290x1057)

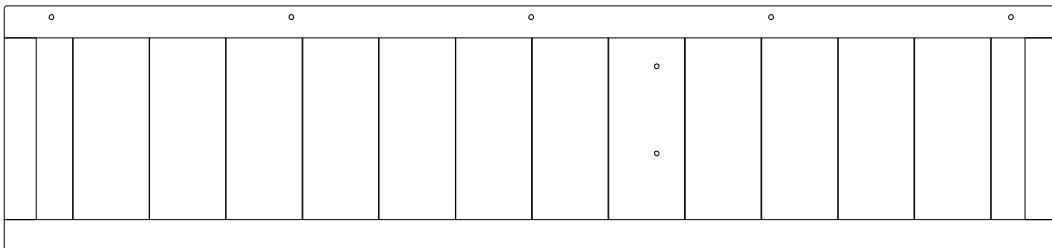

WP12 WALL PANEL - W2A04224
(x1) 1"x10 1/4"x43 7/8" (24x260x1115)

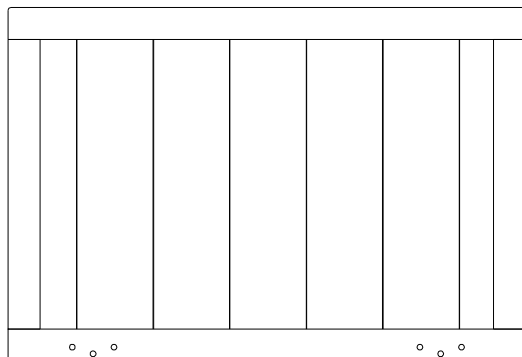

DP01 DOOR PANEL - W2A04148
(x1) 1"x10 1/4"x43 7/8" (24x374x548)

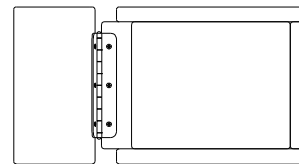

MB01 MAILBOX - W2A04223
(x1) 3 3/8"x6 9/16"x8 3/4" (86x166x222)

Owner's Manual - Parts Identification

Wood Components (Not to Scale)

RP01 ROOF PANEL - W2A04130
(x1) 1 3/8"x24 5/8"x41 7/8" (35x625x1064)

RP02 ROOF PANEL - W2A04131
(x1) 1 3/8"x21 1/8"x41 7/8" (35x535x1064)

Owner's Manual - Parts Identification

Hardware Components

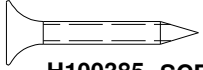

H100385 SCREW PFH BLK
(x4) 8x1

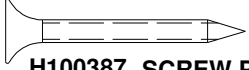

H100387 SCREW PFH BLK
(x25) 8x1 1/4

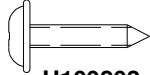

H100202 SCREW PWH BLK
(x2) 8x5/8

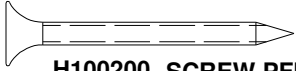

H100200 SCREW PFH BLK
(x39) 8x1 1/2

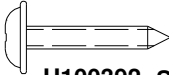

H100392 SCREW PWH BLK
(x71) 8x3/4

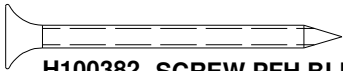

H100382 SCREW PFH BLK
(x6) 8x1 3/4

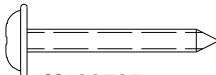

H100797 SCREW PWH BLK
(x4) 8x1

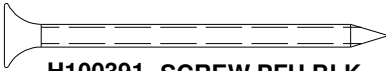

H100391 SCREW PFH BLK
(x23) 8x2

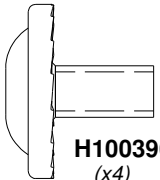

H100396 BOLT WH BLK
(x4) 5/16x1/2

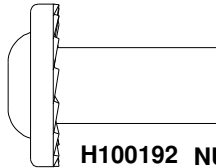

H100192 NUT BARREL WH BLK
(x4) 5/16x7/8

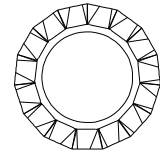

H100199 WASHER LOCK EXT BLK
(x4) 12x19

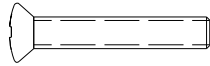

H100807 SCREW POH BLK
(x12) 8/32x1



H100804 T-NUT
(x12) 8/32

Owner's Manual - Parts Identification

Accessory Components (Not to Scale)

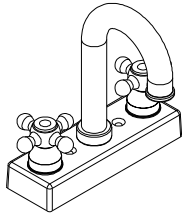

A6P00024 FAUCET KIT
(x1)

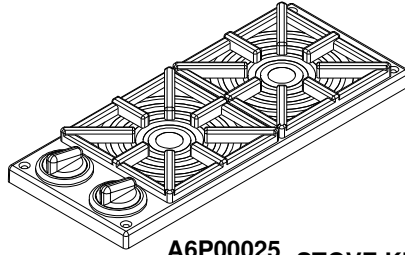

A6P00025 STOVE KIT
(x1)

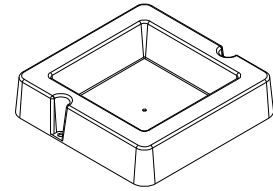

A6P00032 SURFACE MOUNT BASIN
(x1)



A6P00336 BOIL POT
(x1)



A6P00338 FRY PAN
(x1)



A6P00337 POT/PAN LID
(x1)

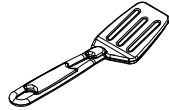

A6P00339 SPATULA
(x1)



A6P00340 LADLE
(x1)

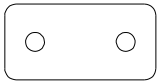

A4M02752 CLEAT
(x8)

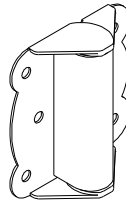

A4M00624 HINGE (DOOR, SPRING LOADED)
(x1)

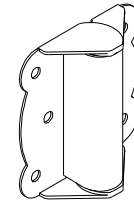

A4M00994 HINGE (DOOR, NON-SPRING LOADED)
(x1)

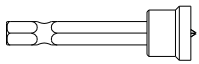

H100764 SCREW SETTER
(x1)

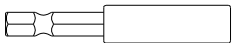

H101100 MAGNETIC DRIVER
(x1)

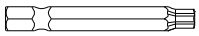

H100147 T-30 TORX BIT
(x1)

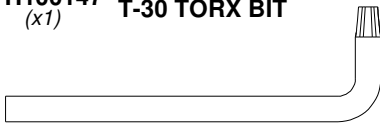

H100114 T-30 TORX WRENCH
(x1)



A4M00527 GROUND STAKE REBAR
(x4)

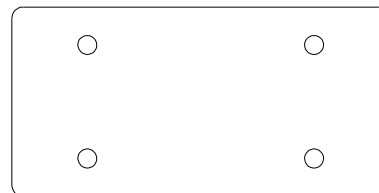

A4M02100 CLEAT
(x12)



A4M02754 METAL TIE STRAP
(x1)

PRE-ASSEMBLY STEP 1 - SORTING PARTS

It is critical for ease of assembly that you take the time to sort and organize the wood and hardware.

WOOD PARTS:

- Organize wood parts by the three-digit, alpha-numeric number stamped on each board (ex. P01).
- If there are multiple boards with the same stamped number, stack those pieces together.
- Stamps can be found on the flat surface of the boards or on the end of the boards.
- Allow yourself plenty of room - the wood pieces can take up a significant amount of space.

NOTE: CARTONS ARE NOT ORGANIZED BY BOARD NUMBER.

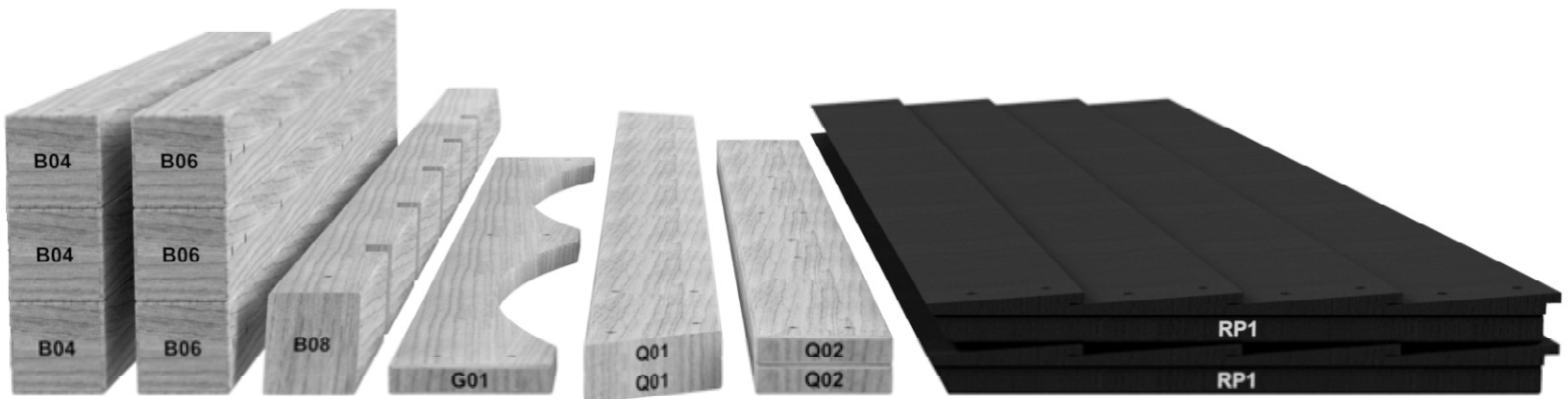

HARDWARE PARTS:

- We recommend that you have a separate table to organize the hardware.
- Hardware bags are printed with a seven-digit, alpha-numeric part number.
- You can organize your hardware by part number or group by hardware type (i.e. bolts, nuts, etc.).
- During assembly you only need to reference the last four digits of the number.



PRE-ASSEMBLY STEP 2 - TOOLS REQUIRED



Cordless Drill or
Electric Drill



Drill Attachments:
Phillips Head



1/8", 3/16", 3/8" & 7/16" Drill Bits



Phillips Screw Driver



Open End Wrenches 1/2" & 9/16"



3/8" Drive Ratchet, 1/2" &
9/16" STD Sockets 1/2" & 9/16" Deep Sockets



Claw Hammer



Rubber Mallet - Optional

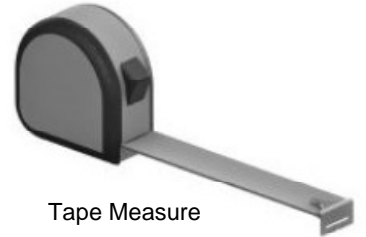

Tape Measure

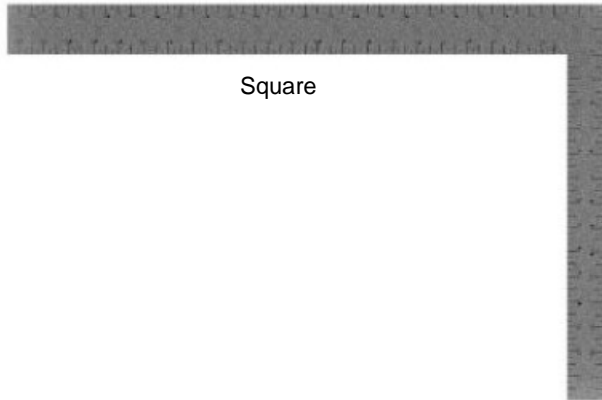

Square



Level 24"

STEP 1 - BOX ASSEMBLY

QTY	PART NUMBER	DESCRIPTION
4	H100200	SCREW PFH 8x1-1/2 BLK

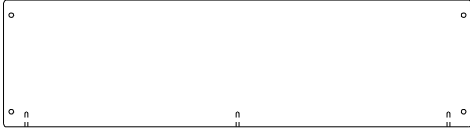

K01 FRONT - W4L19822
(x1) 5/8"x5 1/4"x19 1/2" (16x134x495)

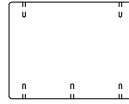

Y01 SIDE - W4L19824
(x2) 5/8"x4"x5 1/4" (16x102x134)

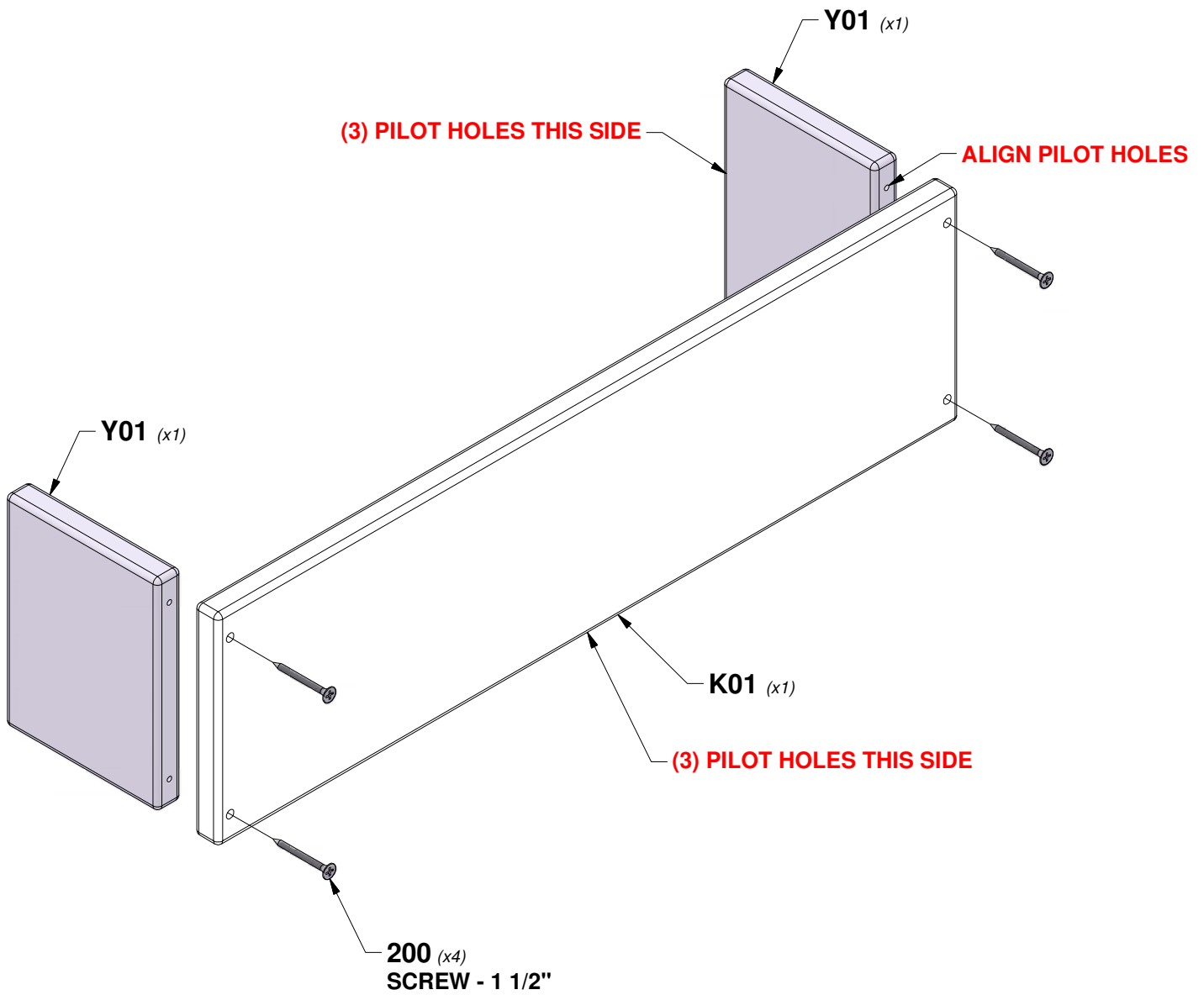

STEP 2 - BOX ASSEMBLY

QTY	PART NUMBER	DESCRIPTION
4	H100200	SCREW PFH 8x1-1/2 BLK

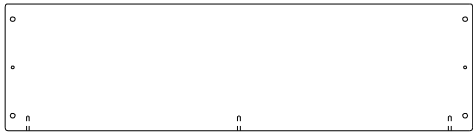

K02 BACK - W4L19823
(x1) 5/8"x5 1/4"x19 1/2" (16x134x495)

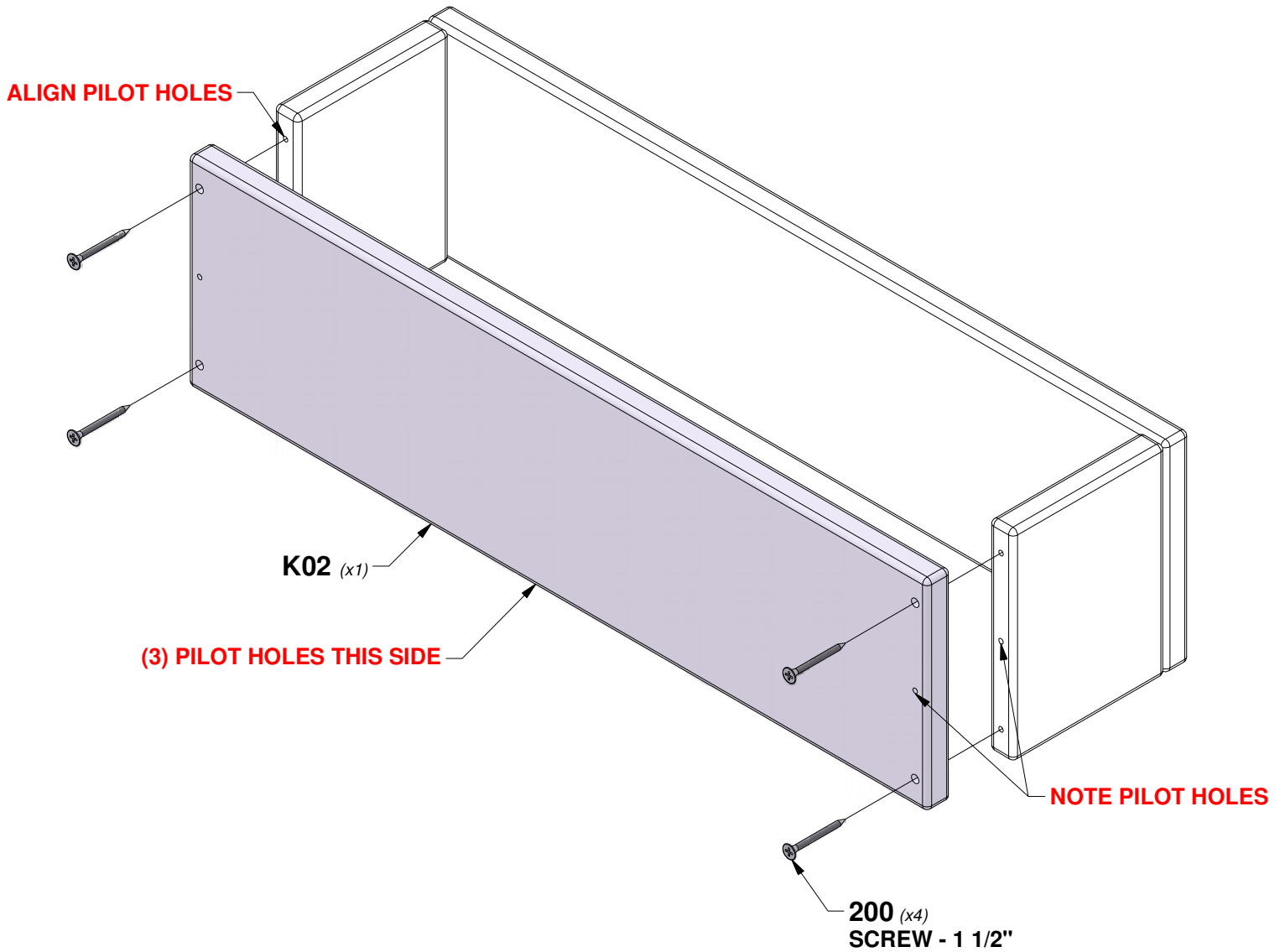

STEP 3 - BOX ASSEMBLY

QTY	PART NUMBER	DESCRIPTION
6	H100200	SCREW PFH 8x1-1/2 BLK



K03 BOTTOM - W4L19825
(x1) 5/8"x5 1/4"x19 1/2" (16x134x495)

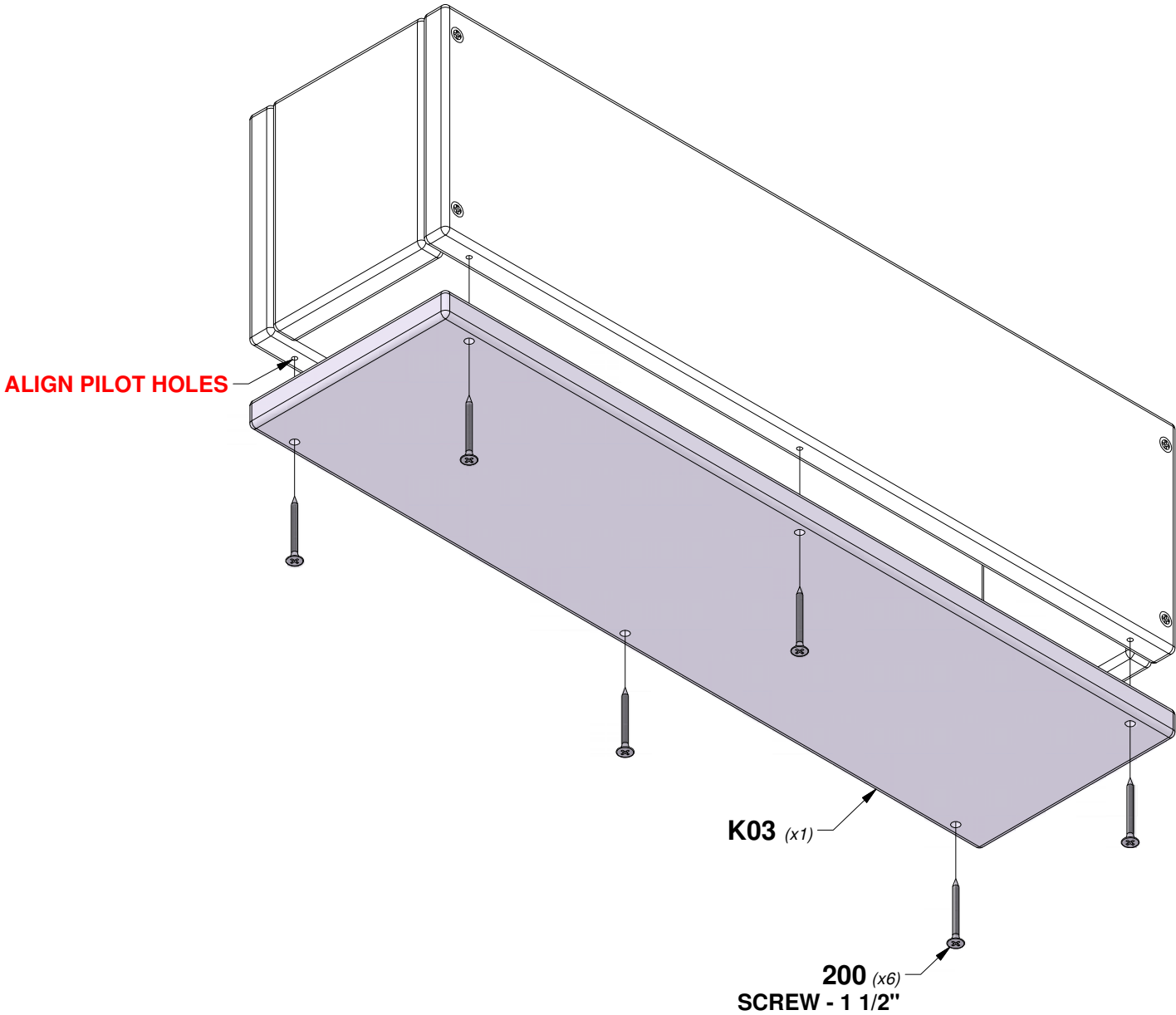

STEP 1 - PLAYHOUSE ASSEMBLY

QTY	PART NUMBER	DESCRIPTION
5	H100391	SCREW PFH 8x2 BLK

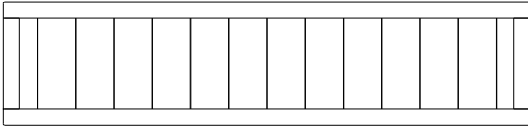

WP01 WALL PANEL - W2A04140
(x1) 1"x10 1/4"x43 7/8" (24x260x1115)

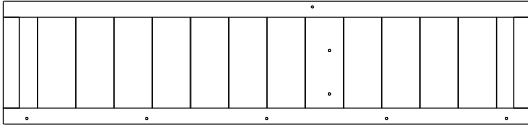

WP02 WALL PANEL - W2A04141
(x1) 1"x10 1/4"x43 7/8" (24x260x1115)

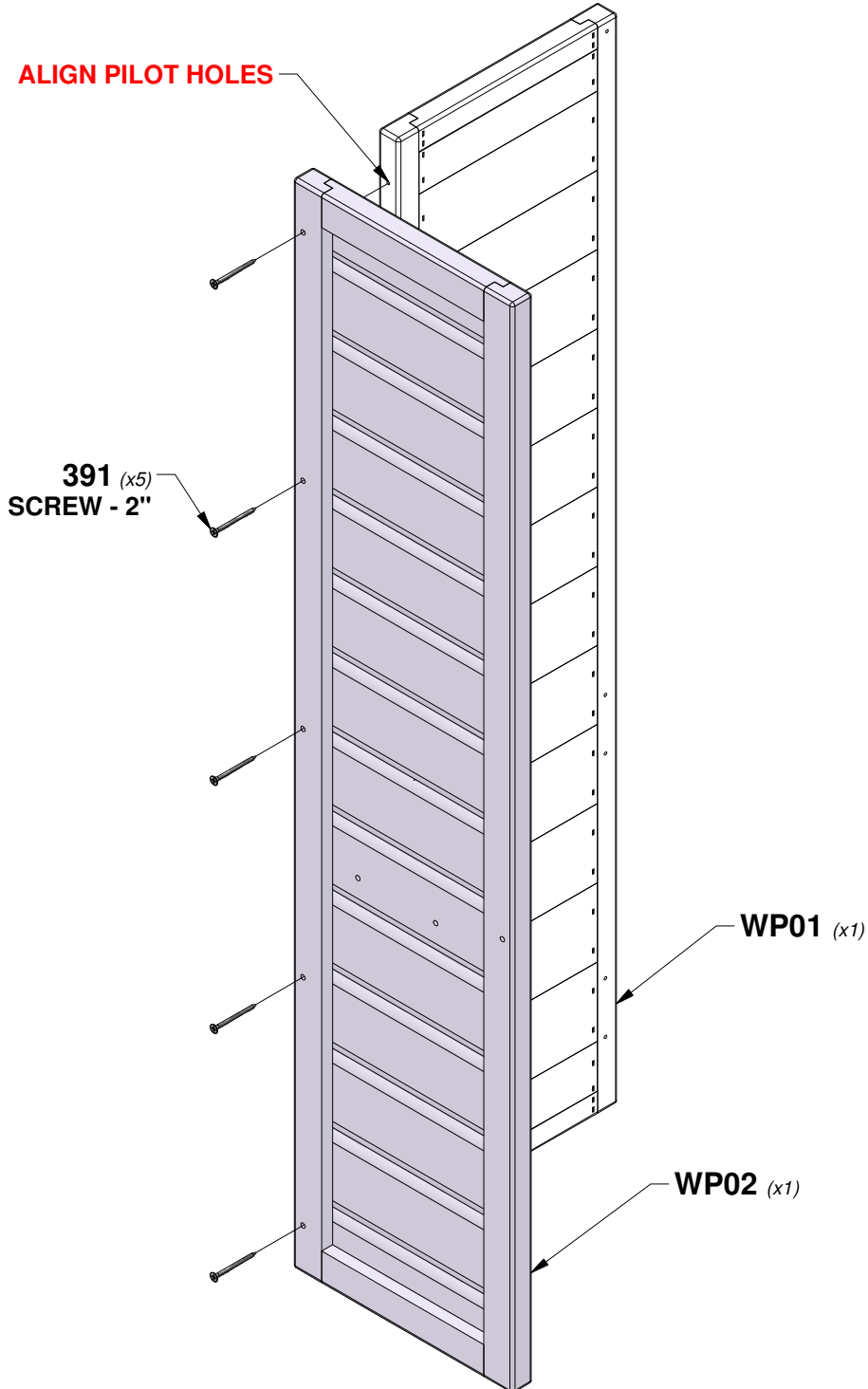

STEP 2 - PLAYHOUSE ASSEMBLY

QTY	PART NUMBER	DESCRIPTION
8	H100392	SCREW PWH 8x3/4 BLK

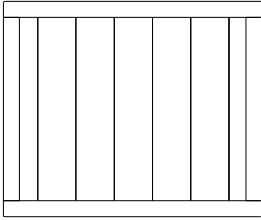

WP04 WALL PANEL - W2A04143
 (x1) 1"x10 1/4"x43 7/8" (24x455x548)



A4M02100 CLEAT
 (x2)

TIP:
ALIGN PILOT HOLES

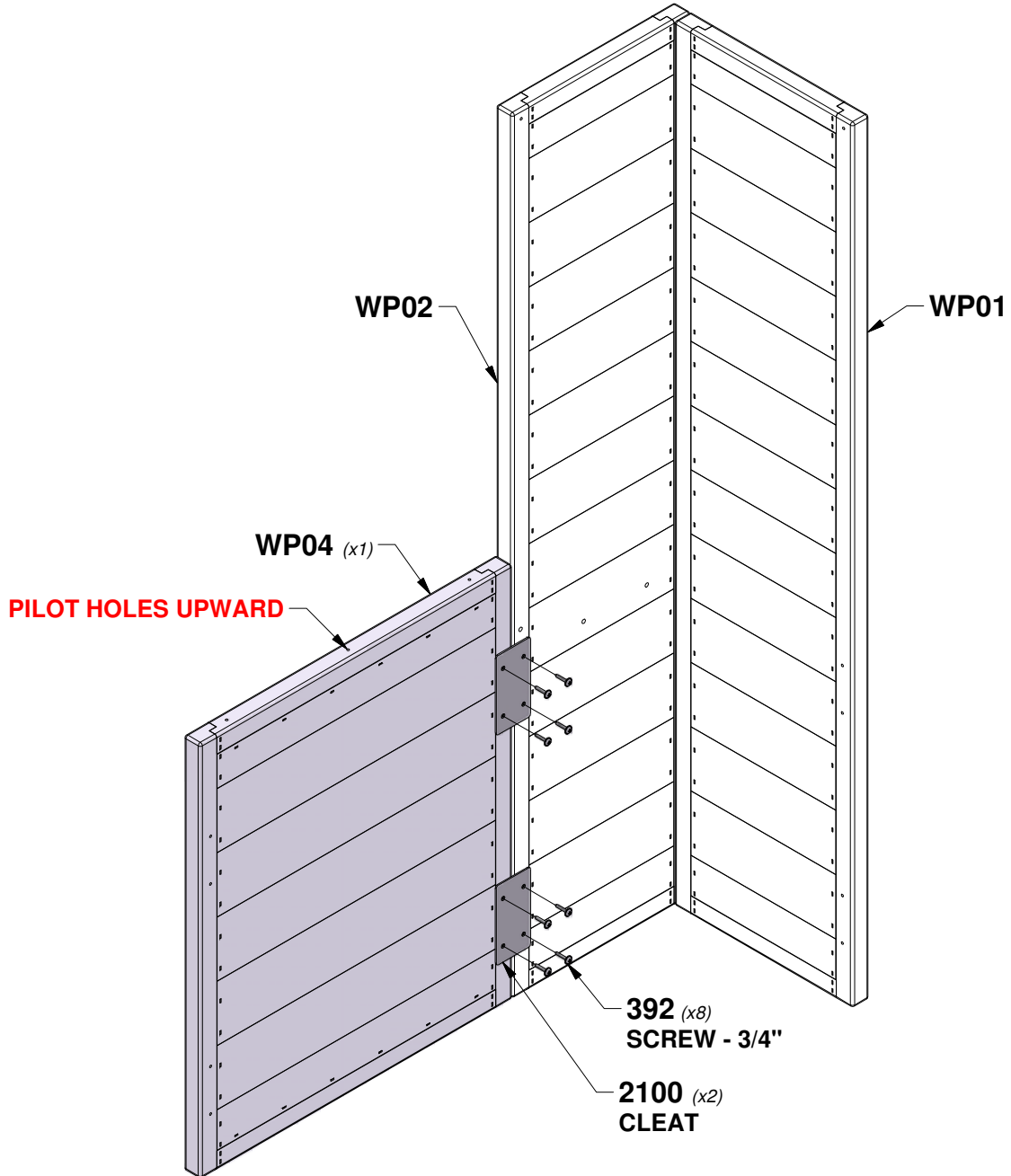

STEP 3 - PLAYHOUSE ASSEMBLY

QTY	PART NUMBER	DESCRIPTION
8	H100392	SCREW PWH 8x3/4 BLK

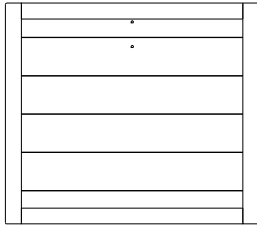

WP05 WALL PANEL - W2A04144
(x1) 1"x18 3/8"x21 1/8" (24x467x537)



A4M02100 CLEAT
(x2)

TIP:
ALIGN PILOT HOLES

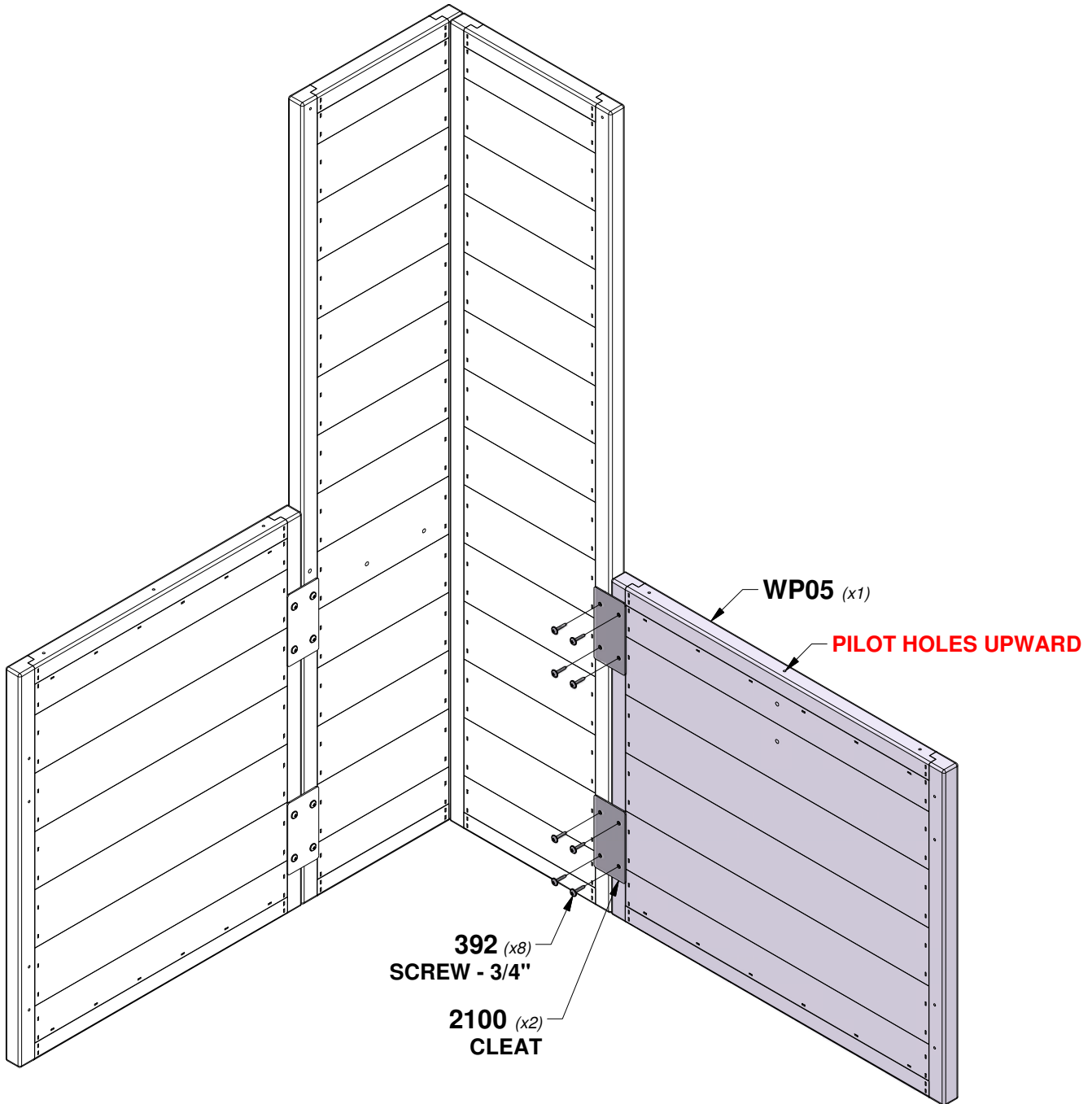

STEP 4 - PLAYHOUSE ASSEMBLY

QTY	PART NUMBER	DESCRIPTION
8	H100392	SCREW PWH 8x3/4 BLK

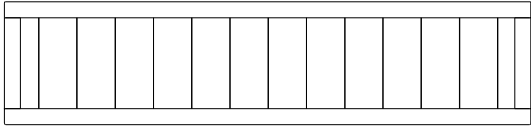

WP09 WALL PANEL - W2A04149
(x1) 1"x10 1/4"x43 7/8" (24x260x1115)



A4M02100 CLEAT
(x2)

TIP:
ALIGN PILOT HOLES

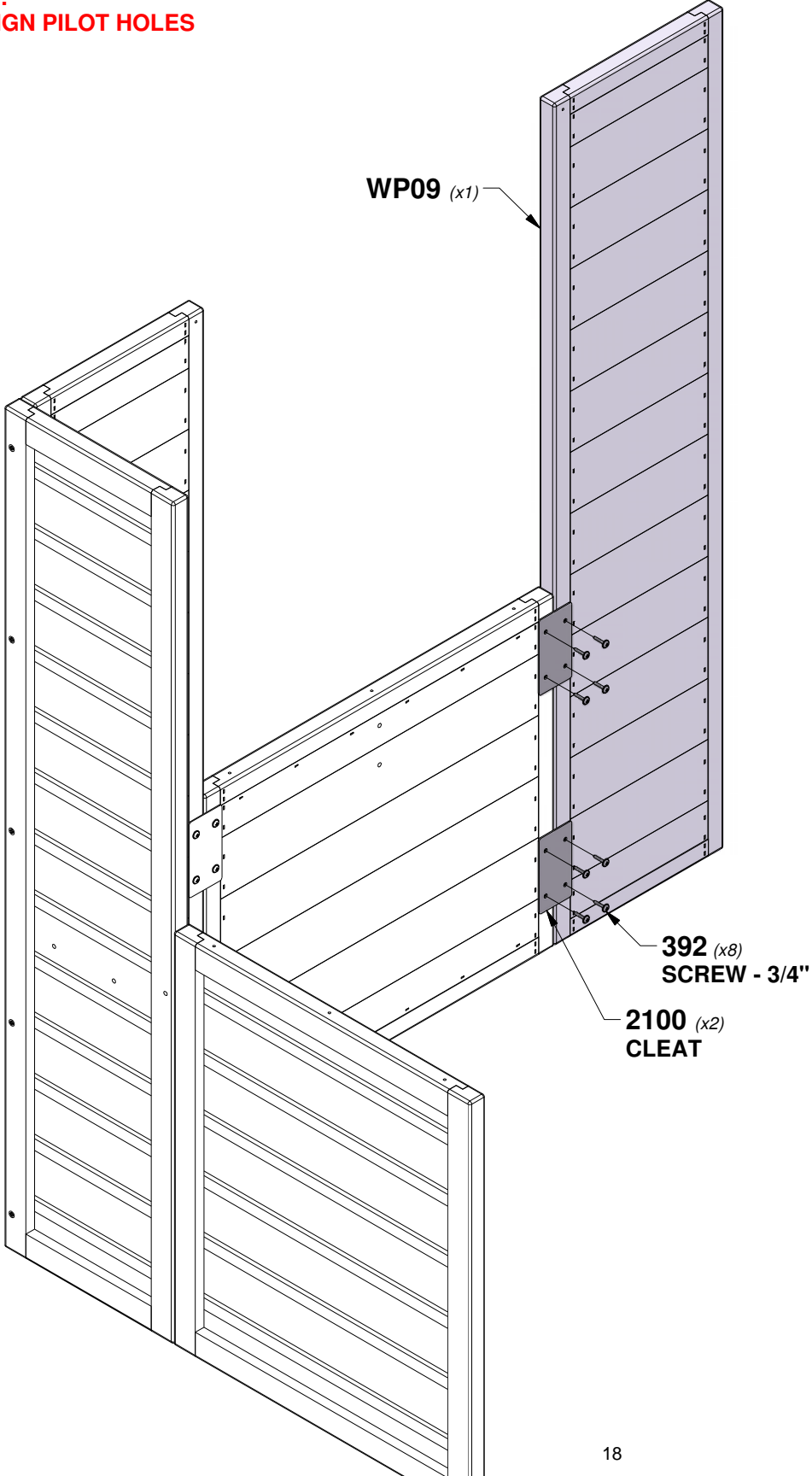

STEP 5 - PLAYHOUSE ASSEMBLY

QTY	PART NUMBER	DESCRIPTION
5	H100391	SCREW PFH 8x2 BLK

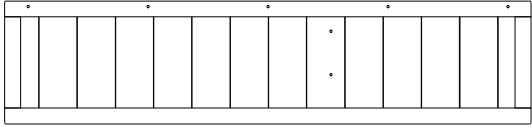

WP12 WALL PANEL - W2A04224
(x1) 1"x10 1/4"x43 7/8" (24x260x1115)

TIP:
ALIGN PILOT HOLES

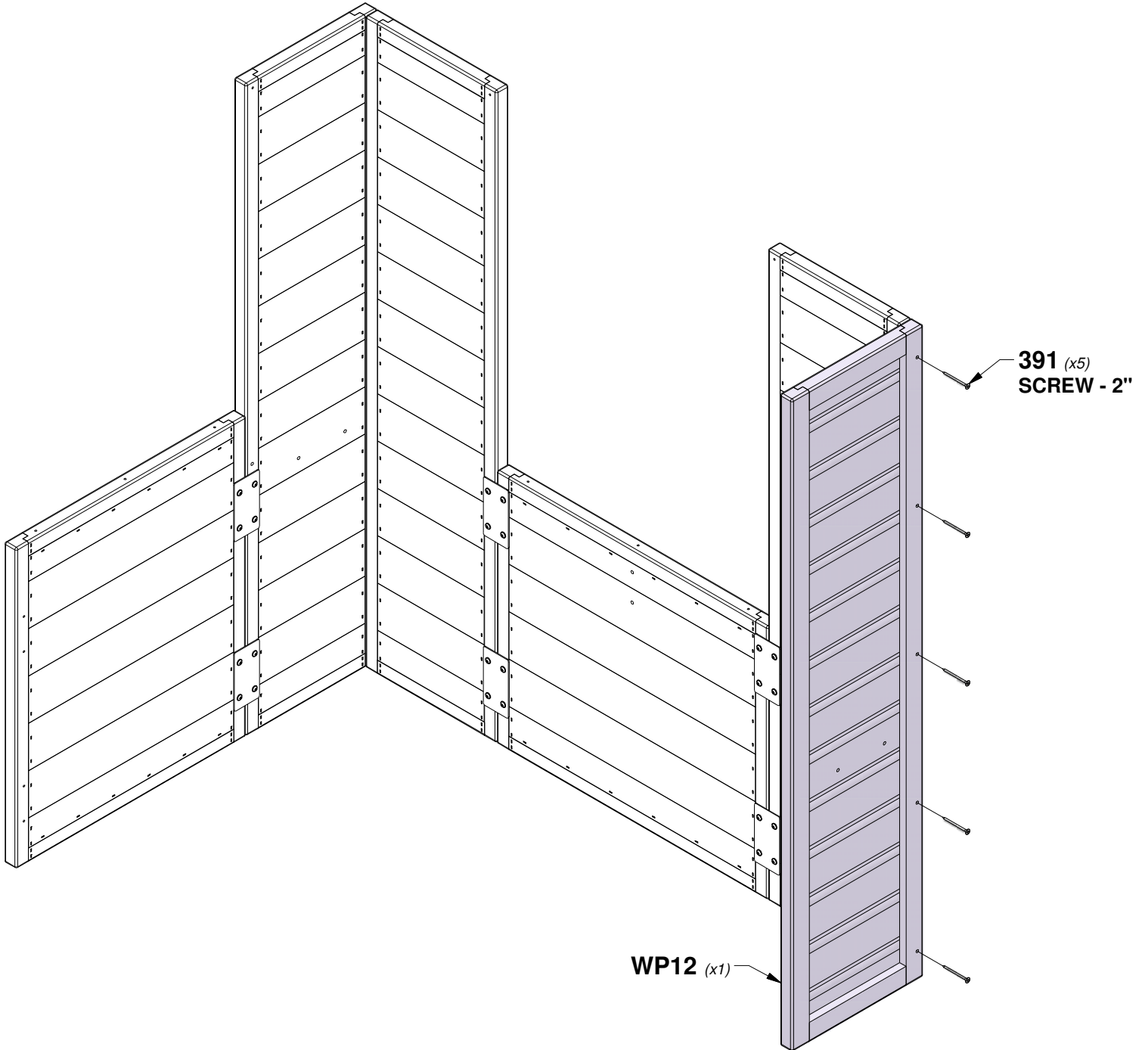

STEP 6 - PLAYHOUSE ASSEMBLY

QTY	PART NUMBER	DESCRIPTION
8	H100392	SCREW PWH 8x3/4 BLK

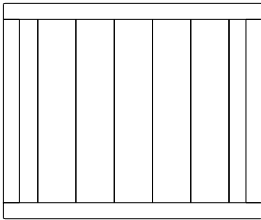

WP04 WALL PANEL - W2A04143
(x1) 1"x10 1/4"x43 7/8" (24x455x548)



A4M02100 CLEAT
(x2)

TIP:
ALIGN PILOT HOLES

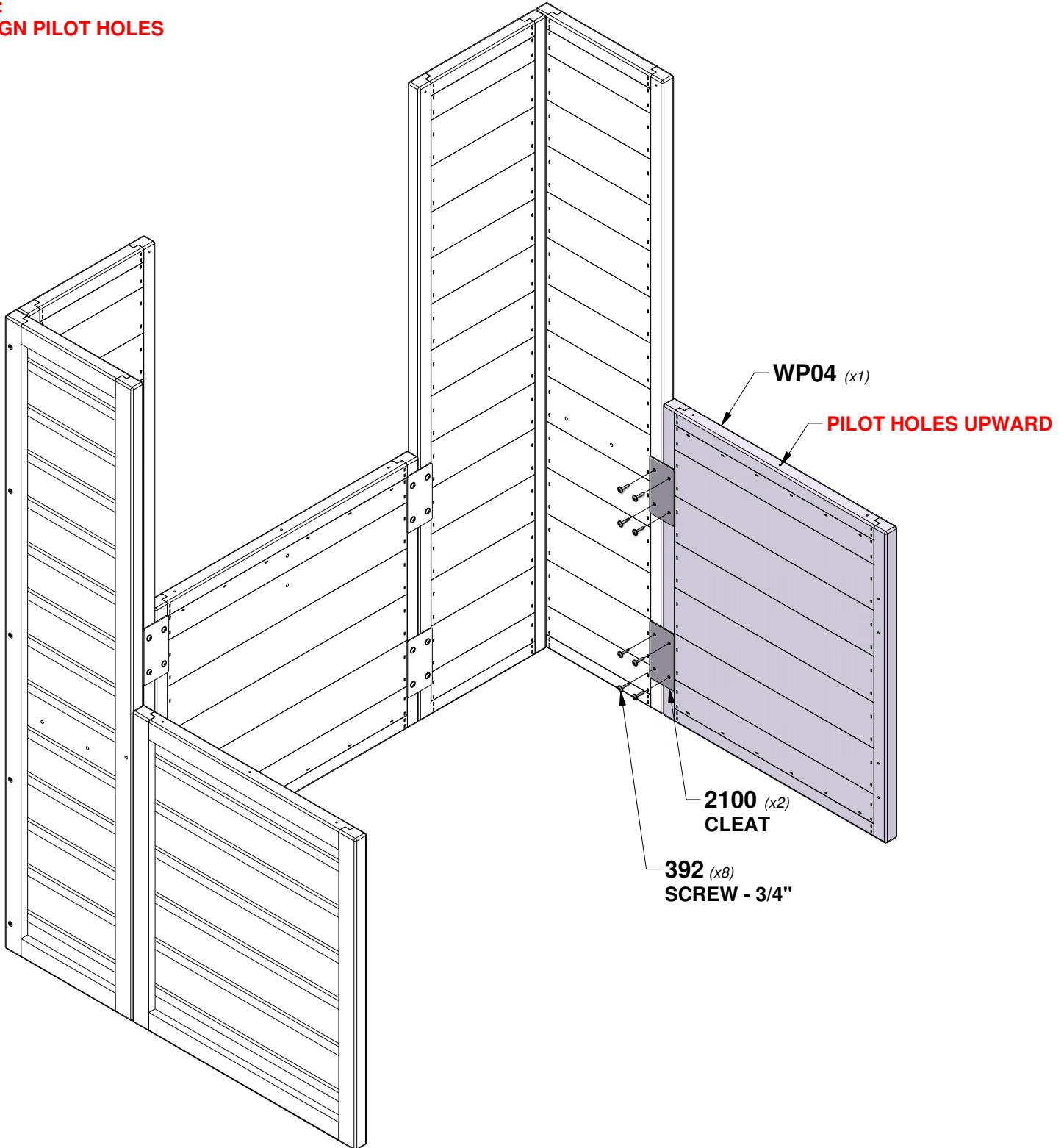

STEP 7 - PLAYHOUSE ASSEMBLY

QTY	PART NUMBER	DESCRIPTION
8	H100392	SCREW PWH 8x3/4 BLK

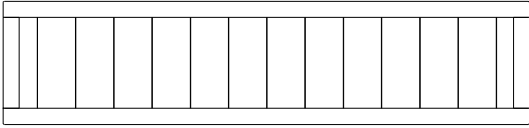

WP10 WALL PANEL - W2A04221
 (x1) 1"x10 1/4"x43 7/8" (24x260x1115)

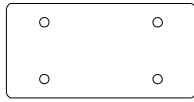

A4M02100 CLEAT
 (x2)

TIP:
ALIGN PILOT HOLES

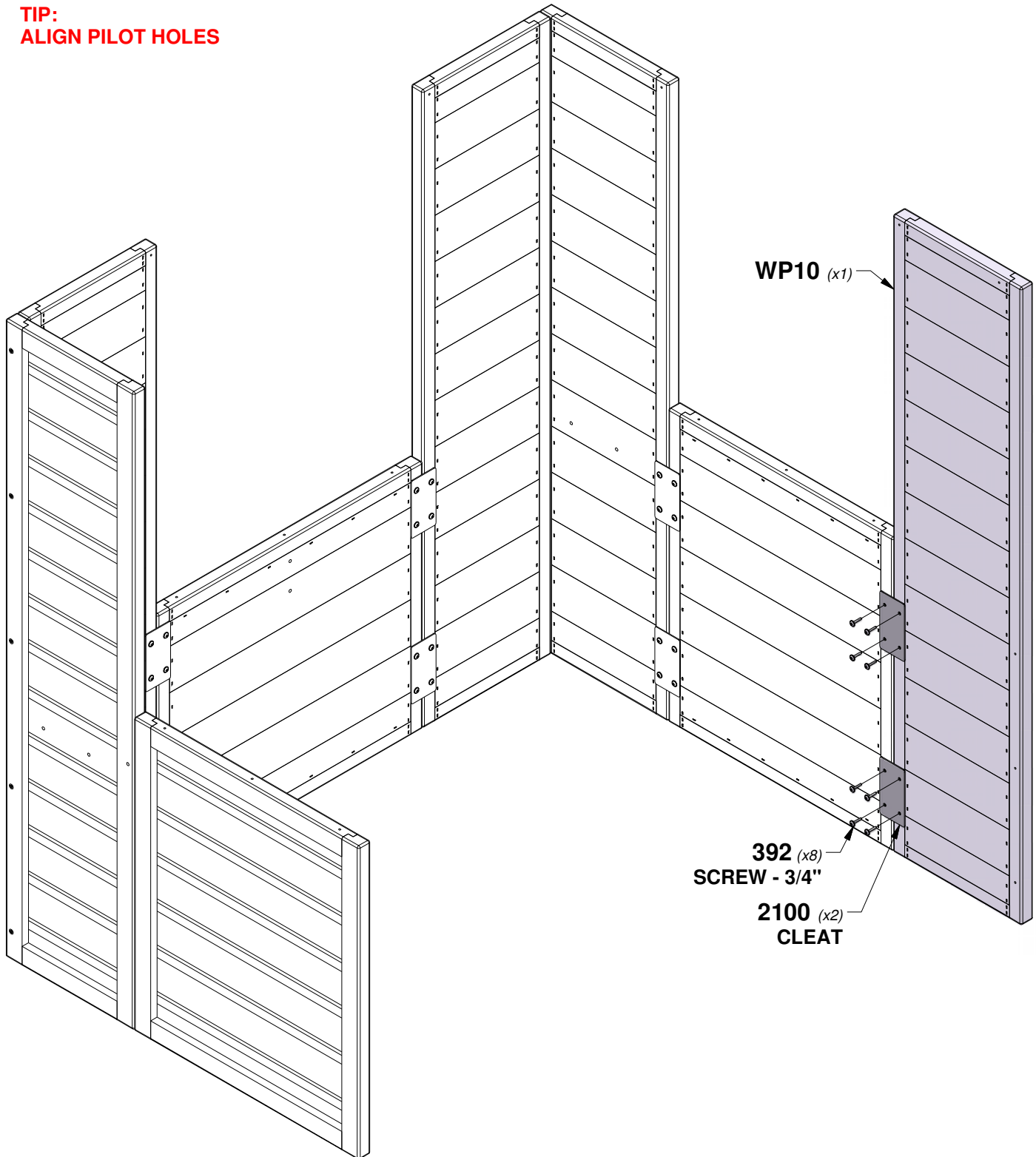

WP10 (x1)

392 (x8)
SCREW - 3/4"

2100 (x2)
CLEAT

STEP 8 - PLAYHOUSE ASSEMBLY

QTY	PART NUMBER	DESCRIPTION
8	H100392	SCREW PWH 8x3/4 BLK

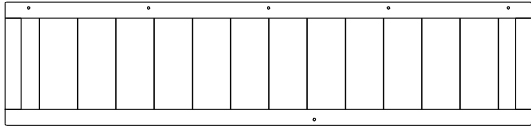

WP03 WALL PANEL - W2A04142
 (x1) 1"x10 1/4"x43 7/8" (24x260x1115)

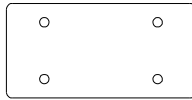

A4M02100 CLEAT
 (x2)

TIP:
ALIGN PILOT HOLES

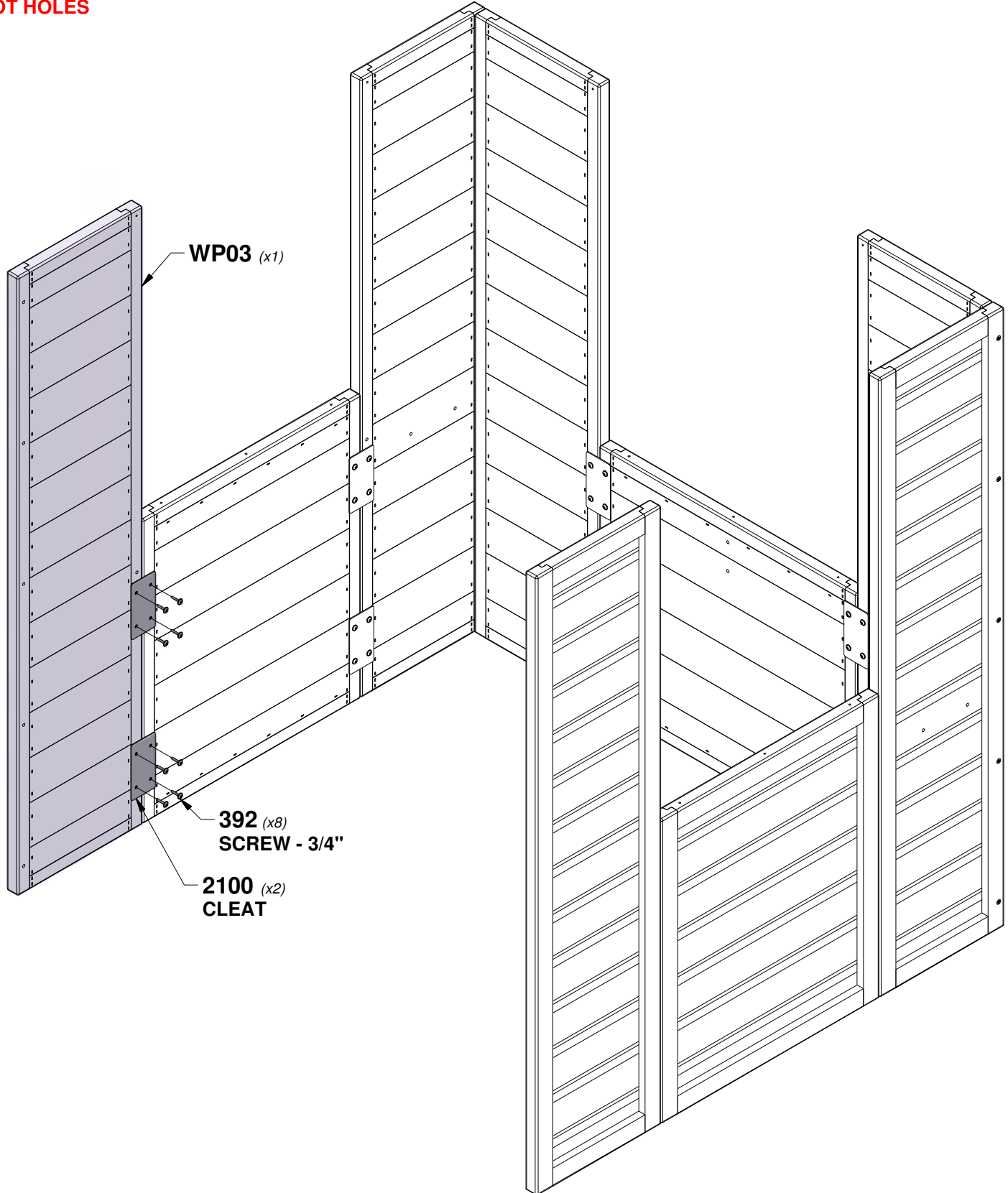

STEP 9 - PLAYHOUSE ASSEMBLY

QTY	PART NUMBER	DESCRIPTION
5	H100391	SCREW PFH 8x2 BLK

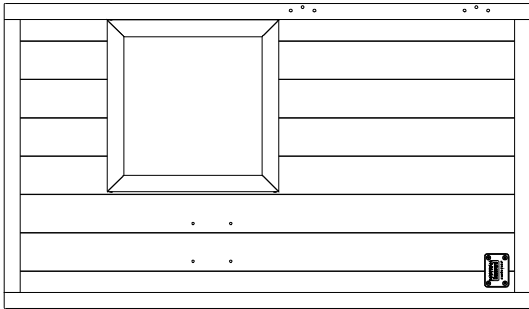

WP07 WALL PANEL - W2A04146
(x1) 1"x10 1/4"x43 7/8" (24x645x1115)

TIP:
ALIGN PILOT HOLES

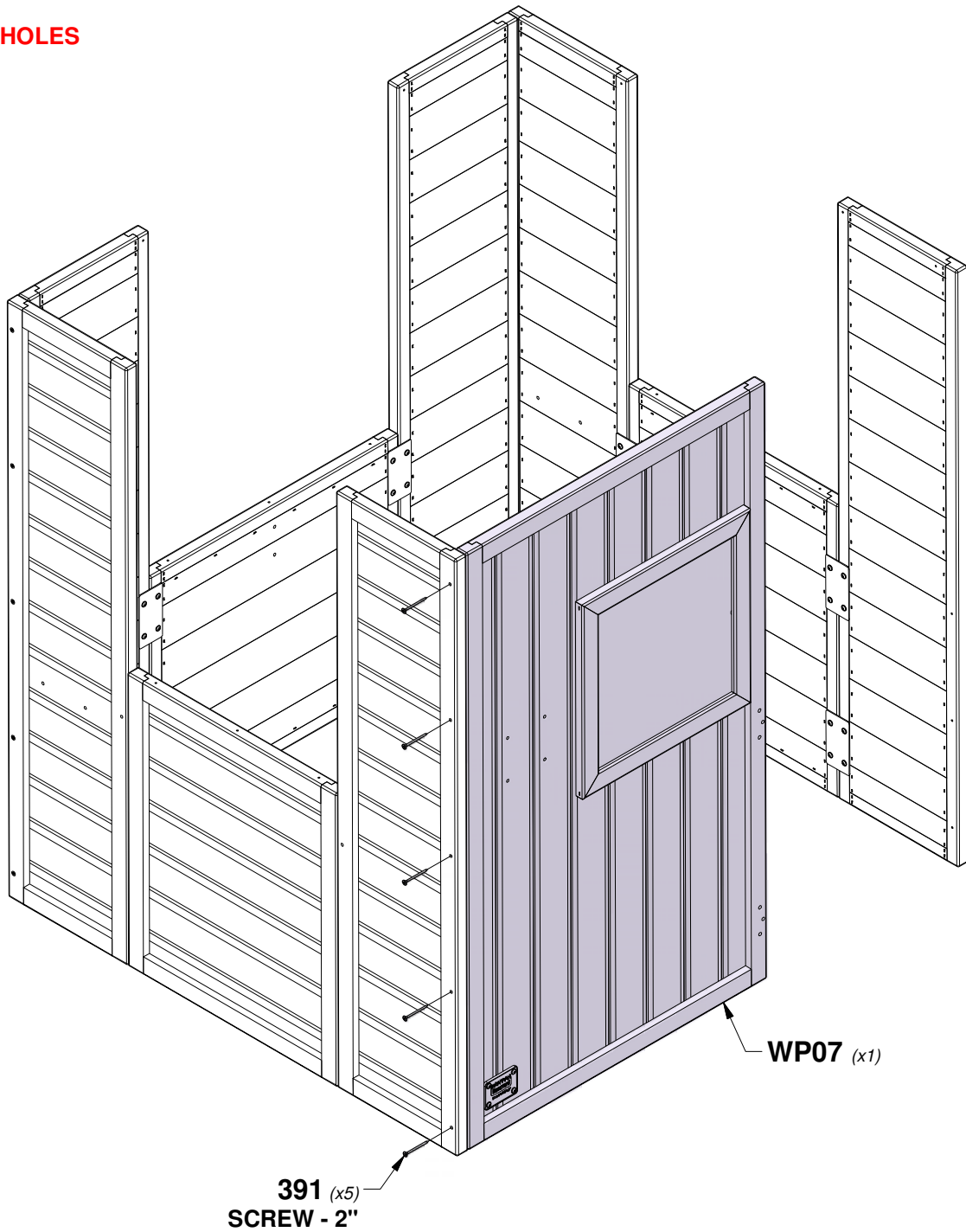

STEP 10 - PLAYHOUSE ASSEMBLY

QTY	PART NUMBER	DESCRIPTION
7	H100392	SCREW PWH 8x3/4 BLK

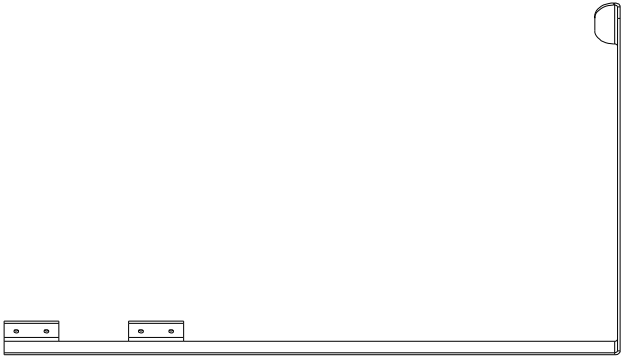

A4M02754
(x1) METAL TIE STRAP

TIP:
ALIGN PILOT HOLES

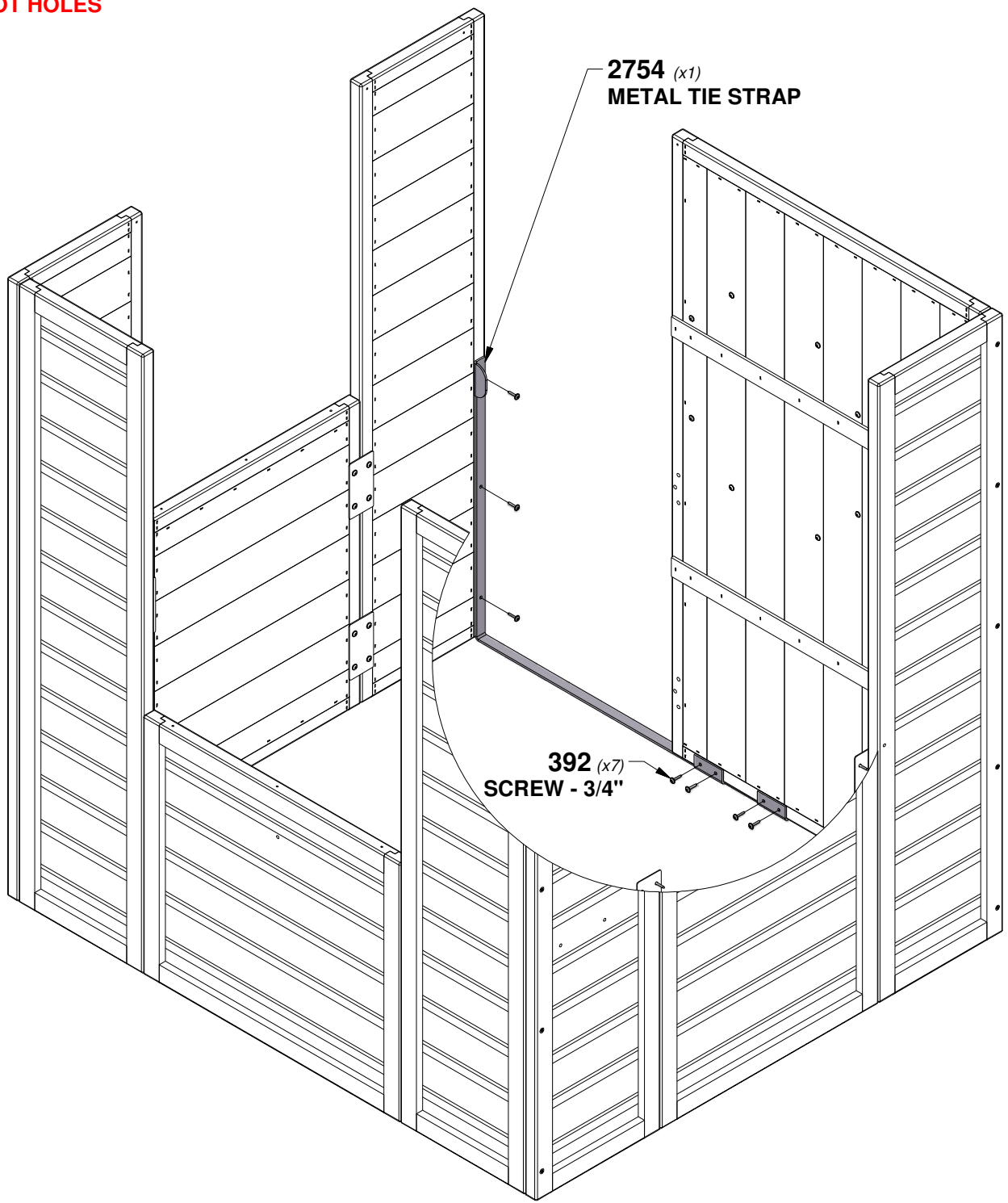

STEP 11 - PLAYHOUSE ASSEMBLY

QTY	PART NUMBER	DESCRIPTION
2	H100200	SCREW PFH 8x1-1/2 BLK
4	H100387	SCREW PFH 8x1-1/4 BLK

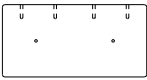

H01 TABLE TOP SUPPORT - W4L19817
 (x2) 1"x3 3/8"x6 3/4" (24x86x172)

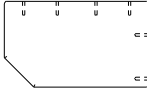

AD01 TABLE TOP SUPPORT - W4L19818
 (x1) 1"x4"x6 3/4" (24x102x172)

TIP:
ALIGN PILOT HOLES

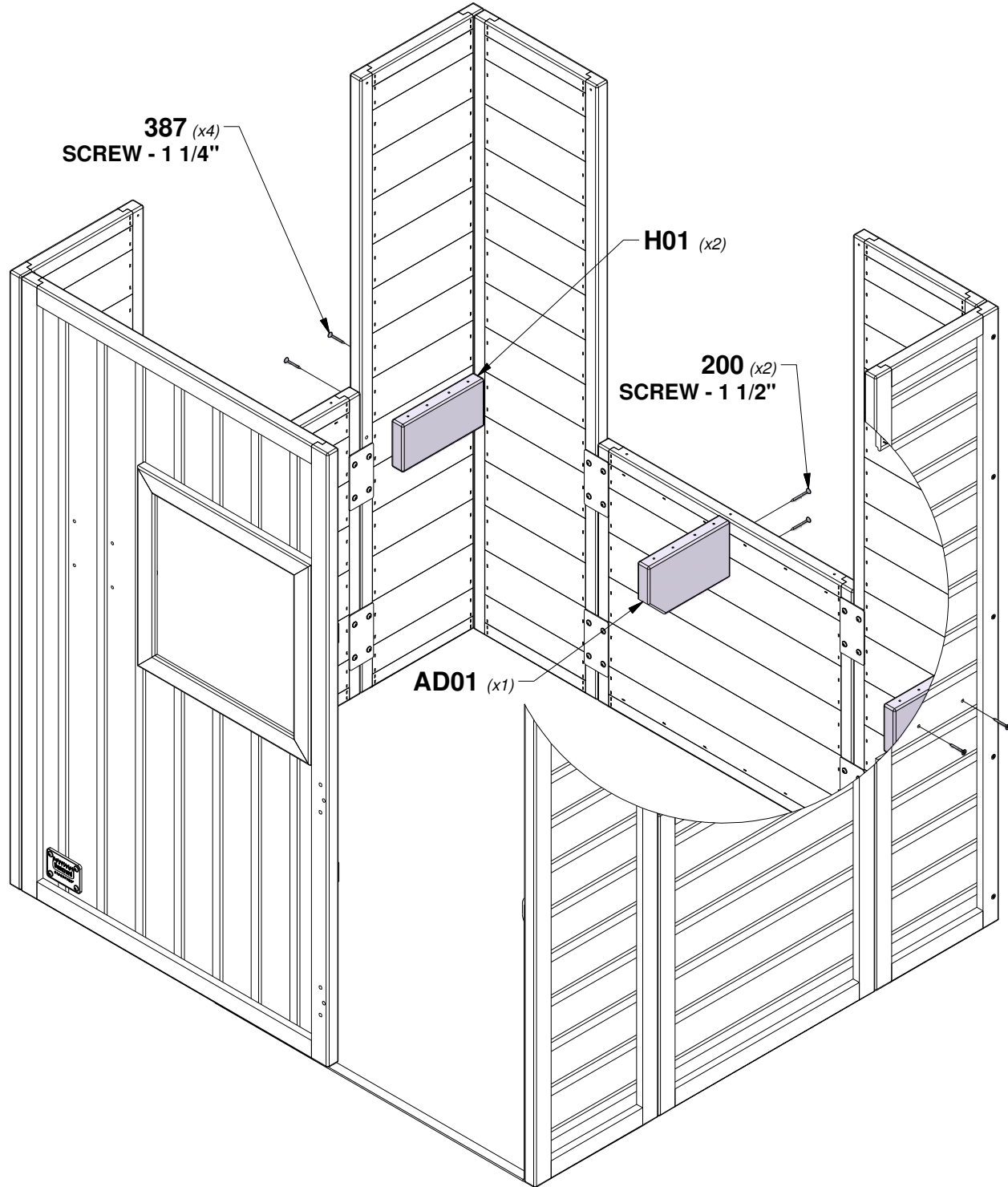

STEP 12 - PLAYHOUSE ASSEMBLY

QTY	PART NUMBER	DESCRIPTION
12	H100200	SCREW PFH 8x1-1/2 BLK

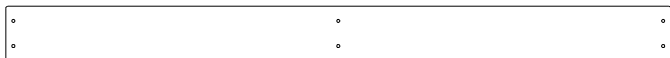

M02 TABLE TOP - W4L19816
(x2) 5/8"x3 3/8"x41 5/8" (16x86x1056)

TIP:
ALIGN PILOT HOLES

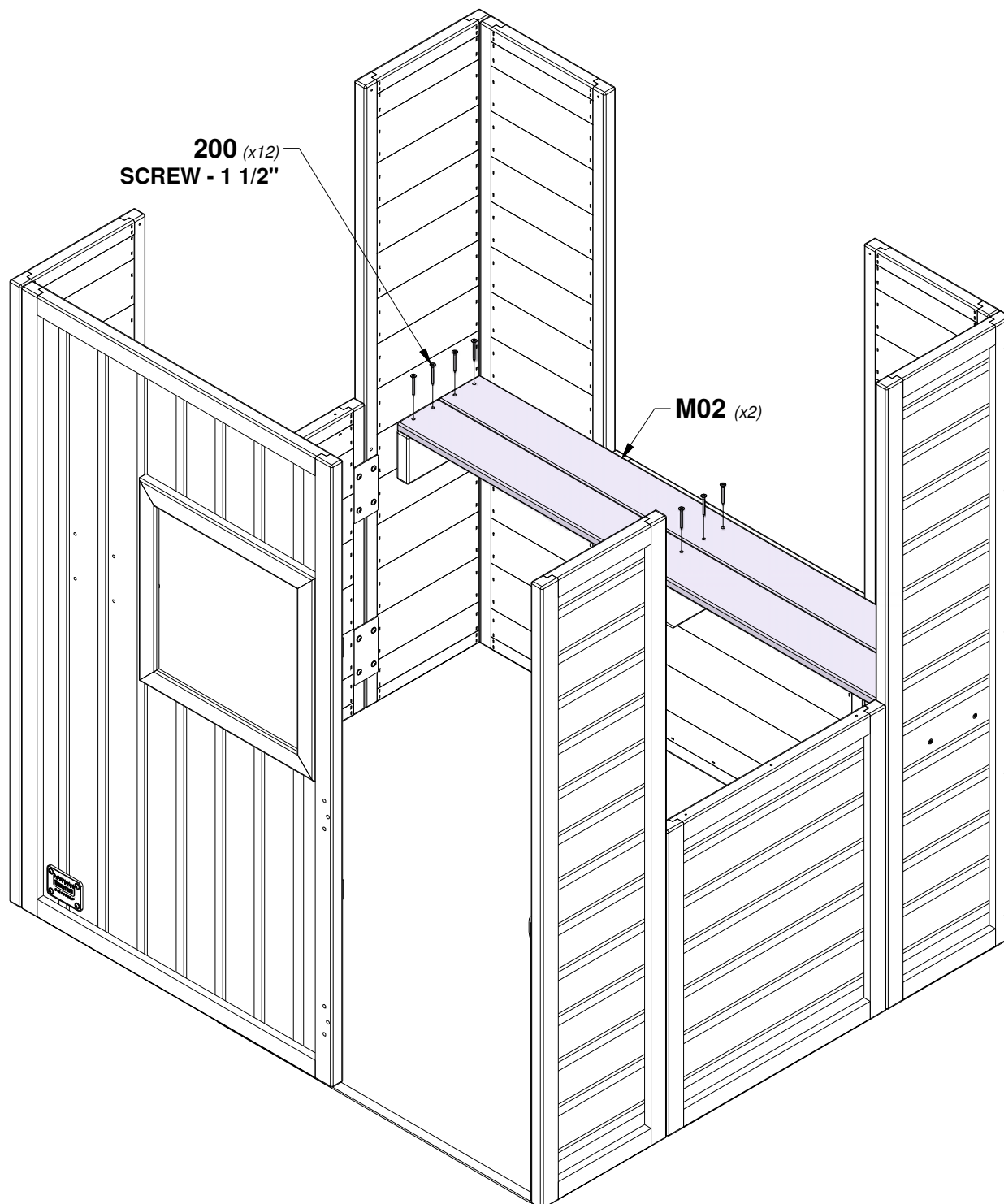

STEP 13 - PLAYHOUSE ASSEMBLY

QTY	PART NUMBER	DESCRIPTION
2	H100200	SCREW PFH 8x1-1/2 BLK

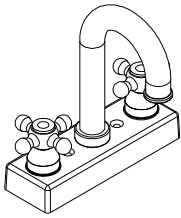

A6P00024
(x1) FAUCET KIT

PLACE AS DESIRED

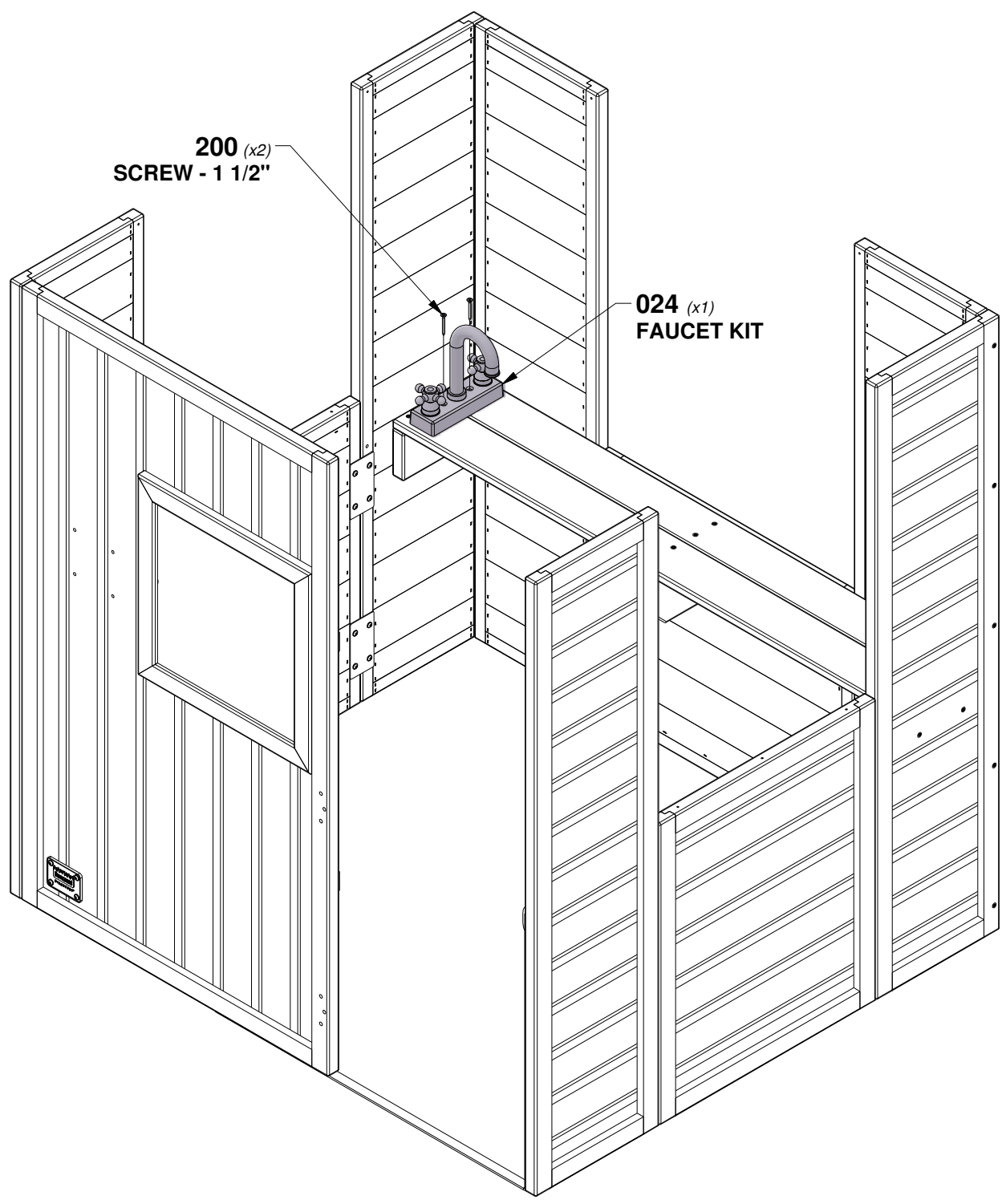

STEP 14 - PLAYHOUSE ASSEMBLY

QTY	PART NUMBER	DESCRIPTION
2	H100202	SCREW PWH 8x5/8 BLK

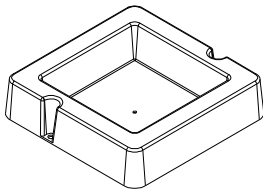

A6P00032 SURFACE MOUNT BASIN
(x1)

PLACE AS DESIRED

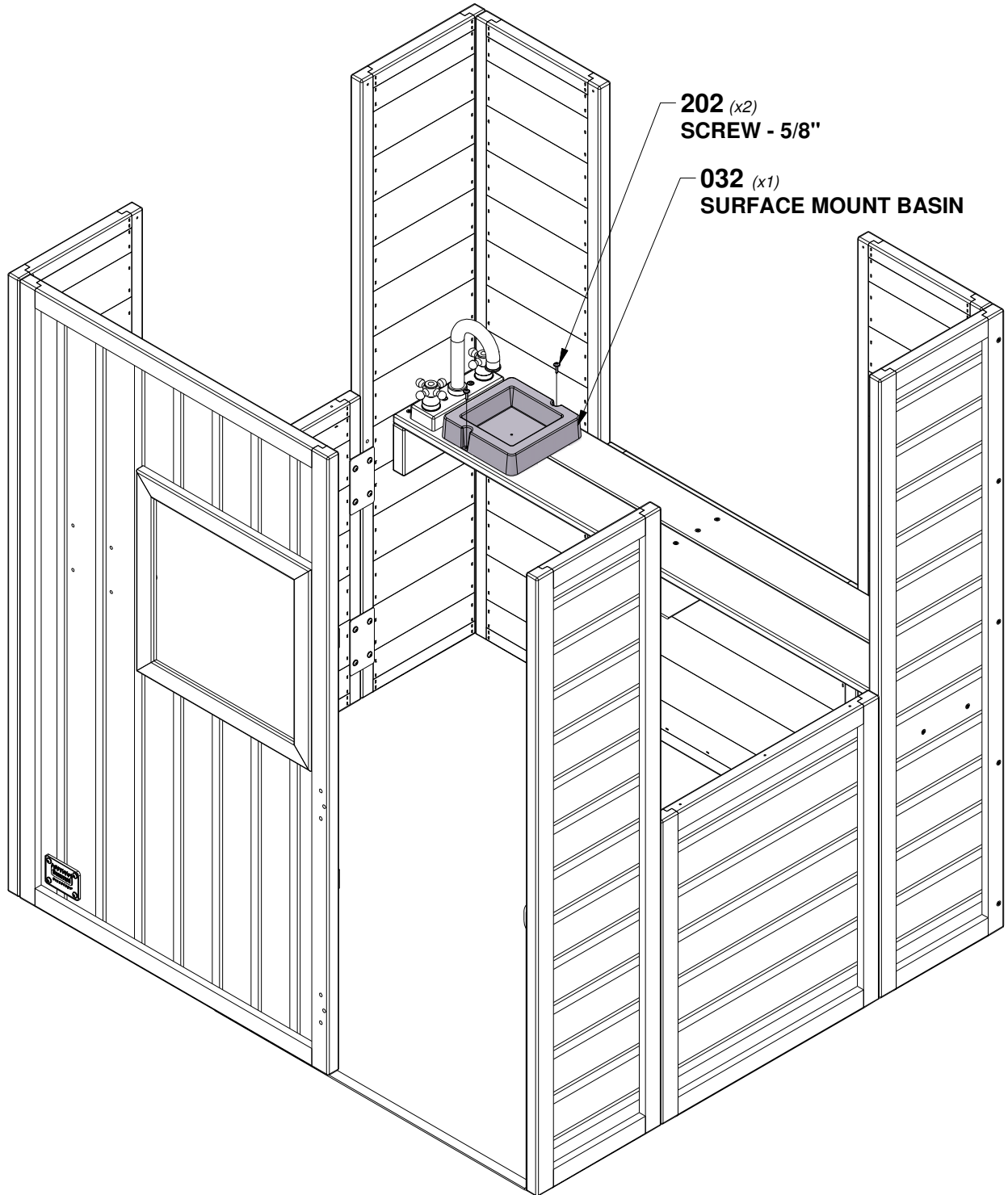

STEP 15 - PLAYHOUSE ASSEMBLY

QTY	PART NUMBER	DESCRIPTION
4	H100385	SCREW PFH 8x1 BLK

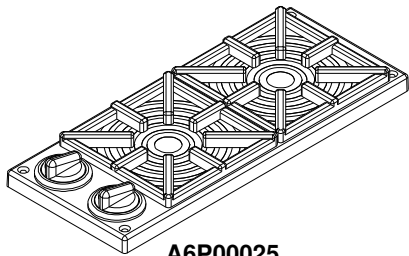

A6P00025
(x1) STOVE KIT

PLACE AS DESIRED

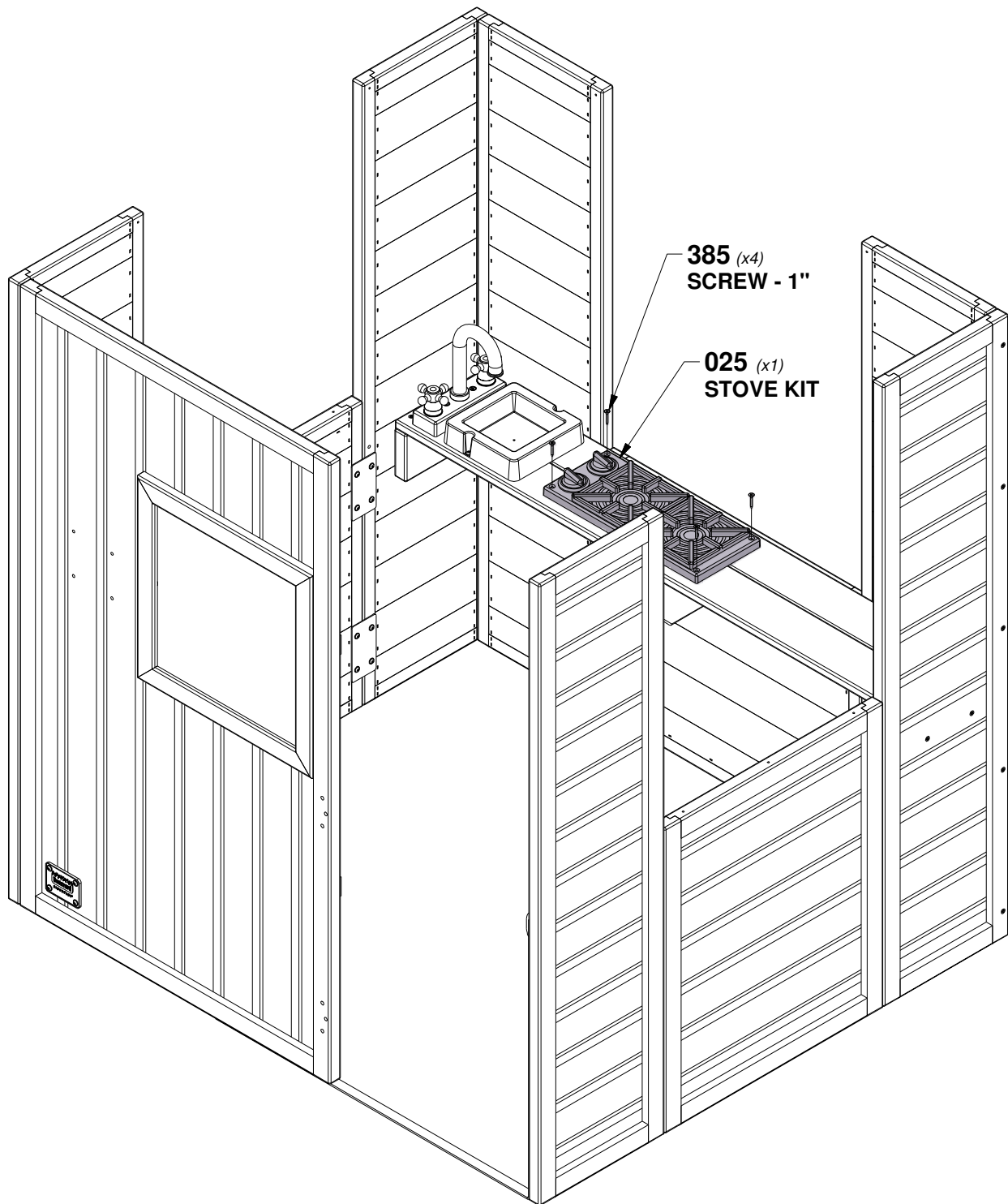

STEP 16 - PLAYHOUSE ASSEMBLY

QTY	PART NUMBER	DESCRIPTION
4	H100392	SCREW PWH 8x3/4 BLK



J01 TOP RAIL - W4L19821
 (x1) 1"x1 3/8"x41 5/8" (24x34x1057)

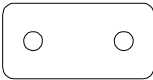

A4M02752 CLEAT
 (x2)

TIP:
ALIGN PILOT HOLES

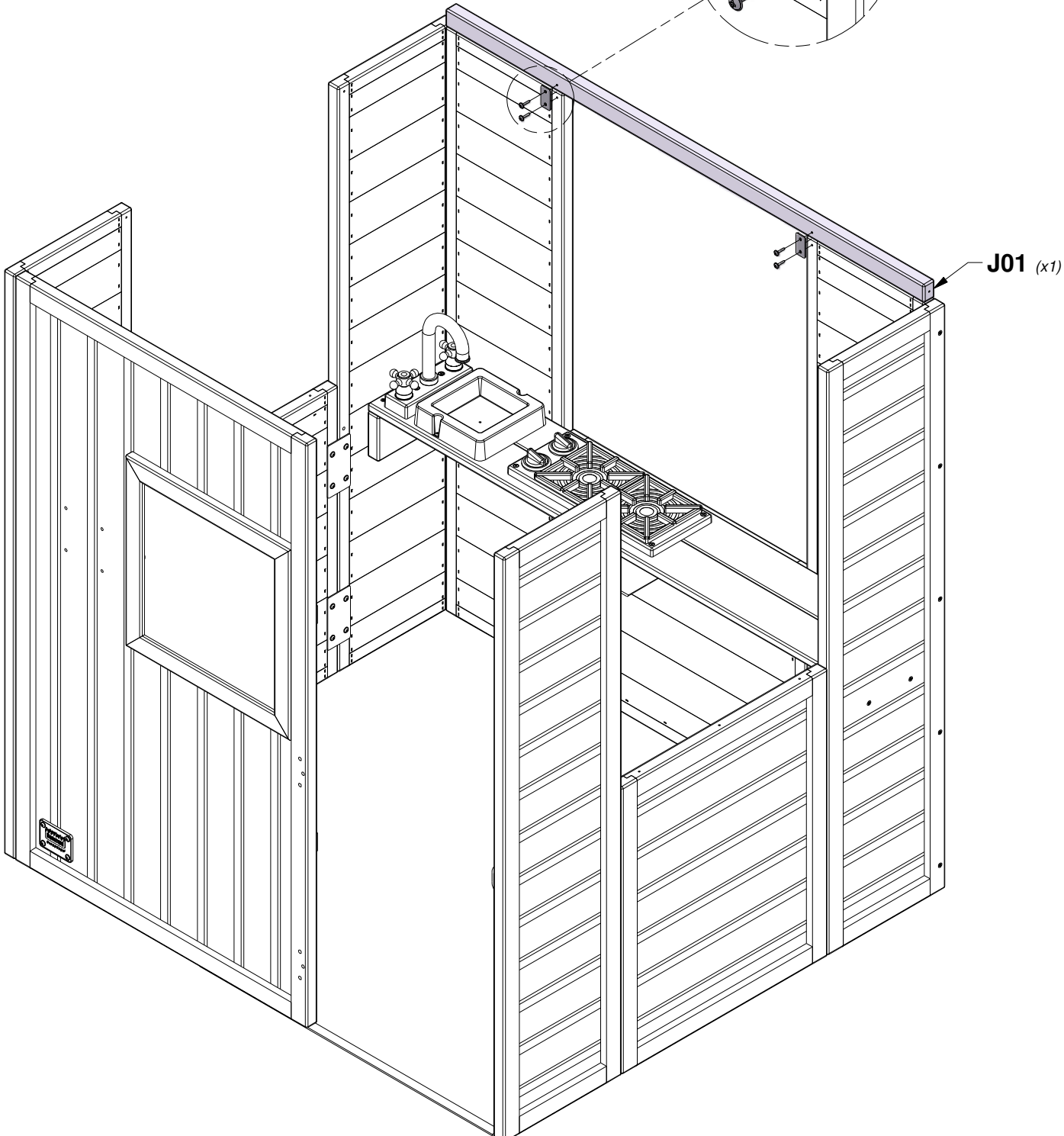
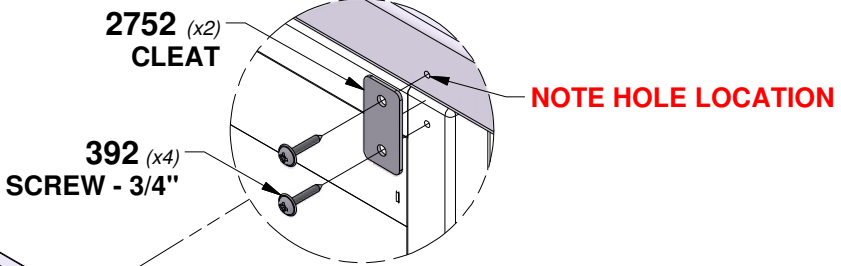

STEP 17 - PLAYHOUSE ASSEMBLY

QTY	PART NUMBER	DESCRIPTION
1	H100391	SCREW PFH 8x2 BLK
4	H100392	SCREW PWH 8x3/4 BLK

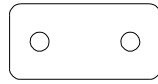
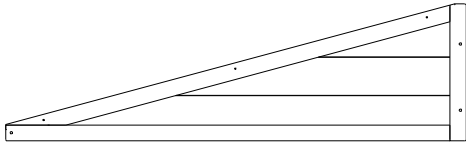

A4M02752
CLEAT
(x2)

WP08 WALL PANEL - W2A04147
(x1) 1"x11 3/8"x38 3/8" (24x290x975)

TIP:
ALIGN PILOT HOLES

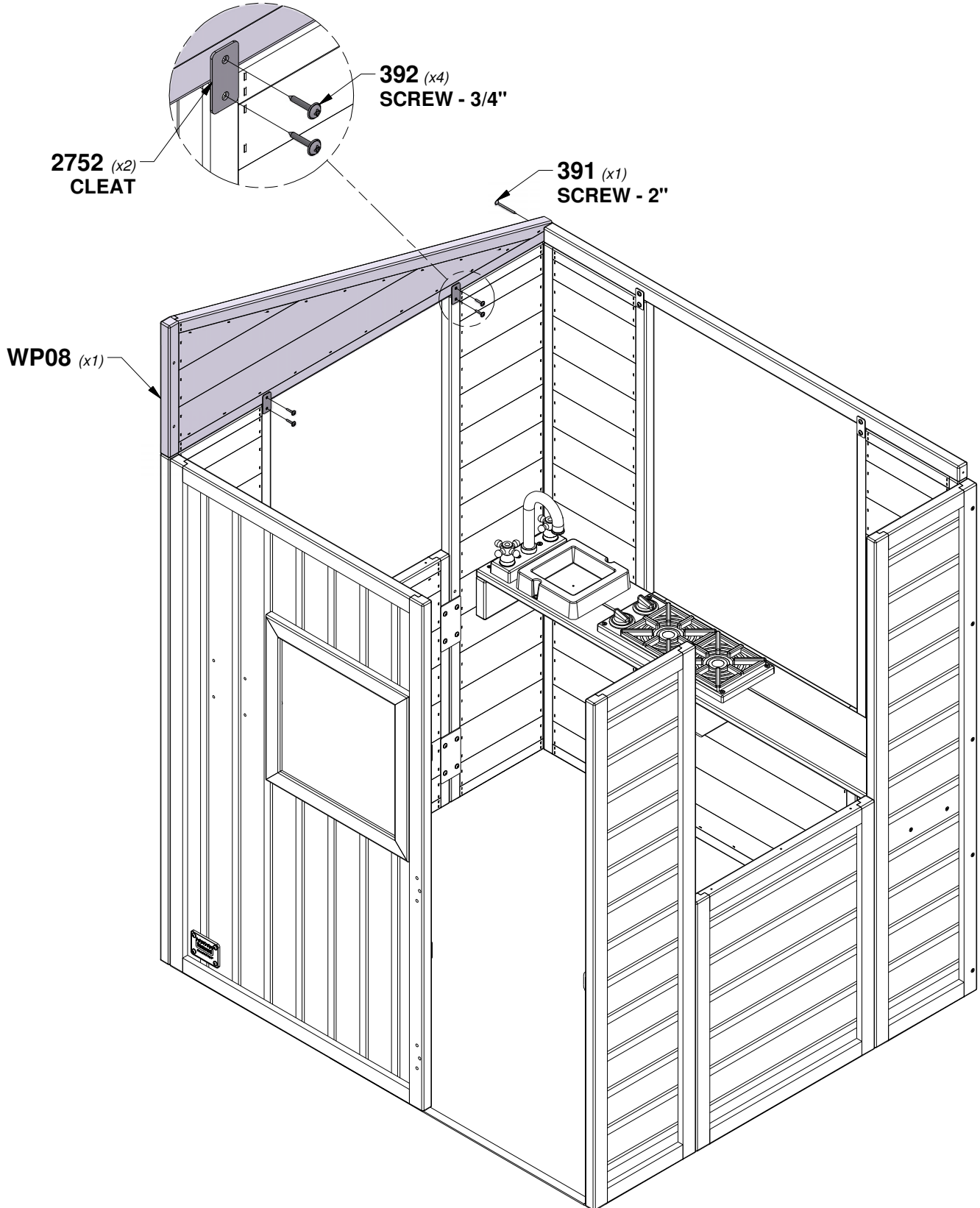

STEP 18 - PLAYHOUSE ASSEMBLY

QTY	PART NUMBER	DESCRIPTION
1	H100391	SCREW PFH 8x2 BLK
6	H100392	SCREW PWH 8x3/4 BLK

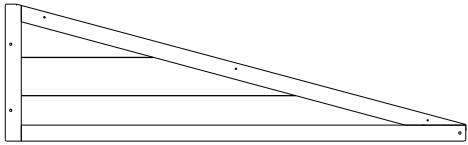

WP06 WALL PANEL - W2A04145
(x1) 1"x11 3/8"x38 3/8" (24x290x975)

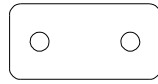

A4M02752 CLEAT
(x3)

TIP:
ALIGN PILOT HOLES

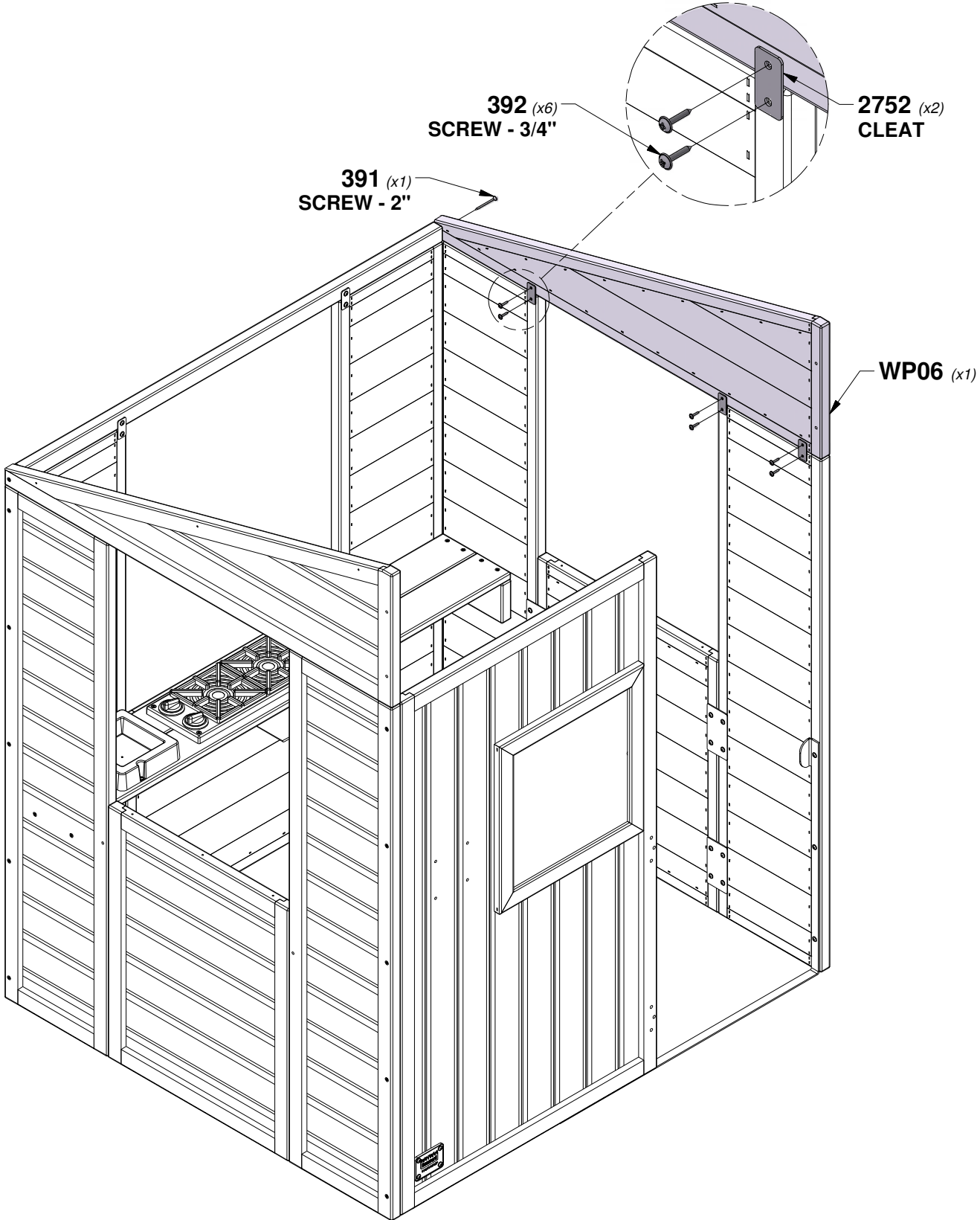

STEP 19 - PLAYHOUSE ASSEMBLY

QTY	PART NUMBER	DESCRIPTION
4	H100391	SCREW PFH 8x2 BLK
2	H100392	SCREW PWH 8x3/4 BLK

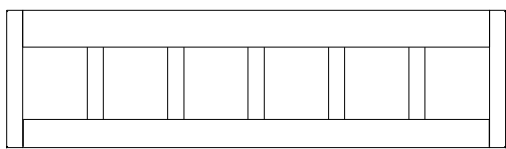

WP11 WALL PANEL - W2A04222
 (x1) 15/16"x11 7/16"x41 5/8" (24x290x1057)

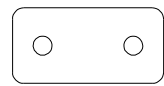

A4M02752 CLEAT
 (x1)

TIP:
ALIGN PILOT HOLES

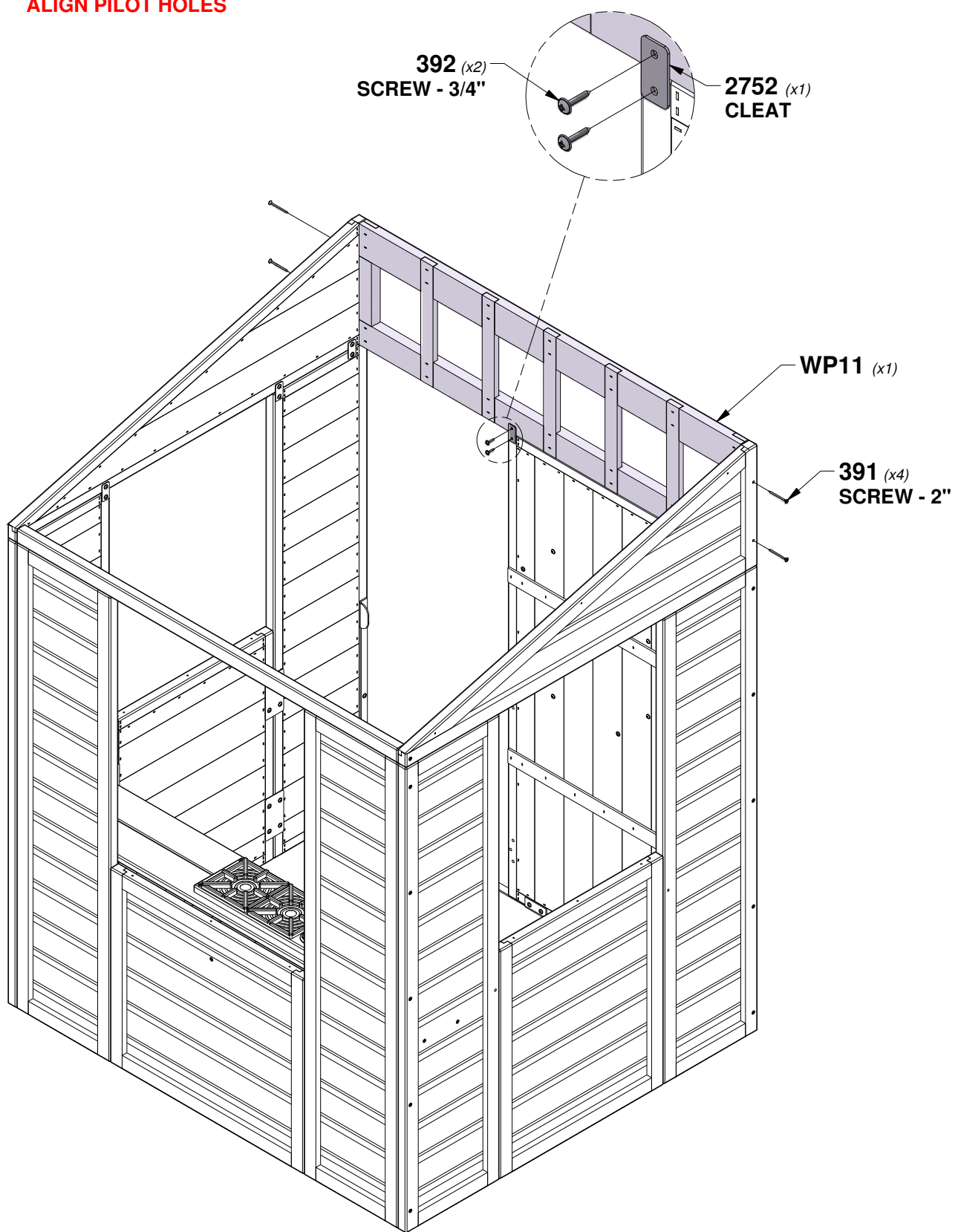

STEP 20 - PLAYHOUSE ASSEMBLY

QTY	PART NUMBER	DESCRIPTION
3	H100382	SCREW PFH 8x1 3/4 BLK

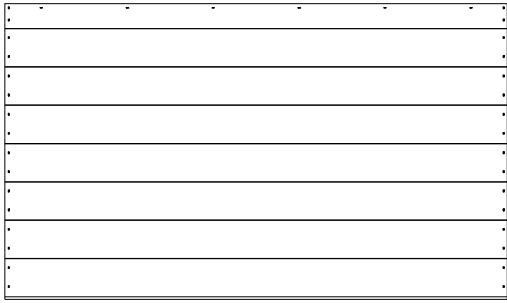

RP01 ROOF PANEL - W2A04130
(x1) 1 3/8"x24 5/8"x41 7/8" (35x625x1064)

TIP:
ALIGN PILOT HOLES

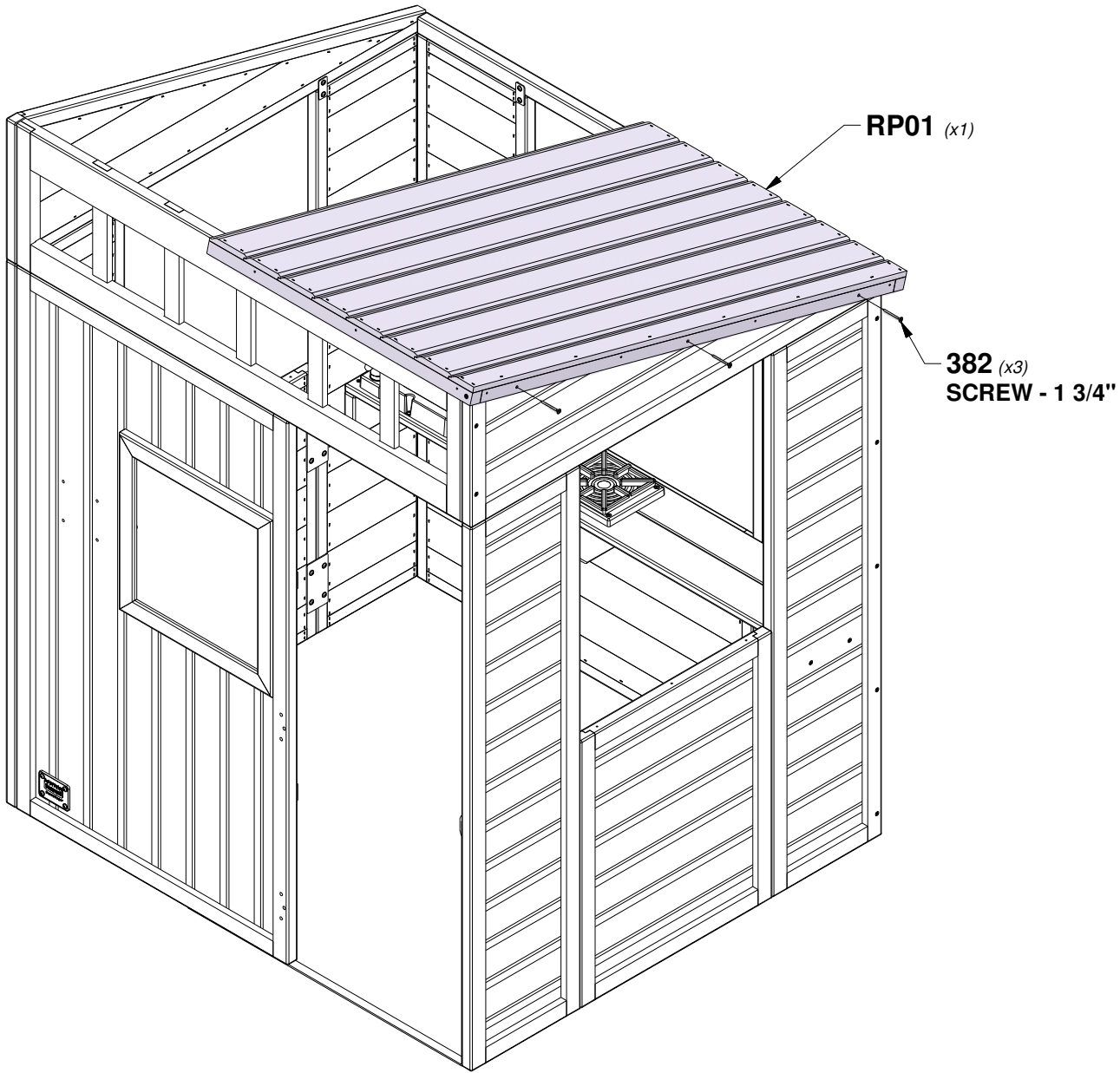

STEP 21 - PLAYHOUSE ASSEMBLY

QTY	PART NUMBER	DESCRIPTION
3	H100382	SCREW PFH 8x1 3/4 BLK

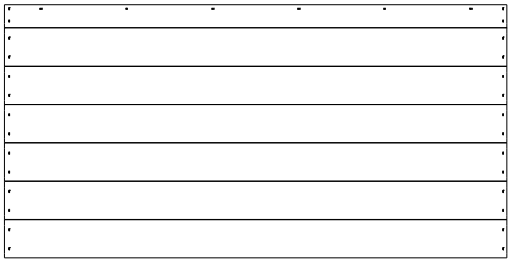

RP02 ROOF PANEL - W2A04131
(x1) 1 3/8"x21 1/8"x41 7/8" (35x535x1064)

TIP:
ALIGN PILOT HOLES

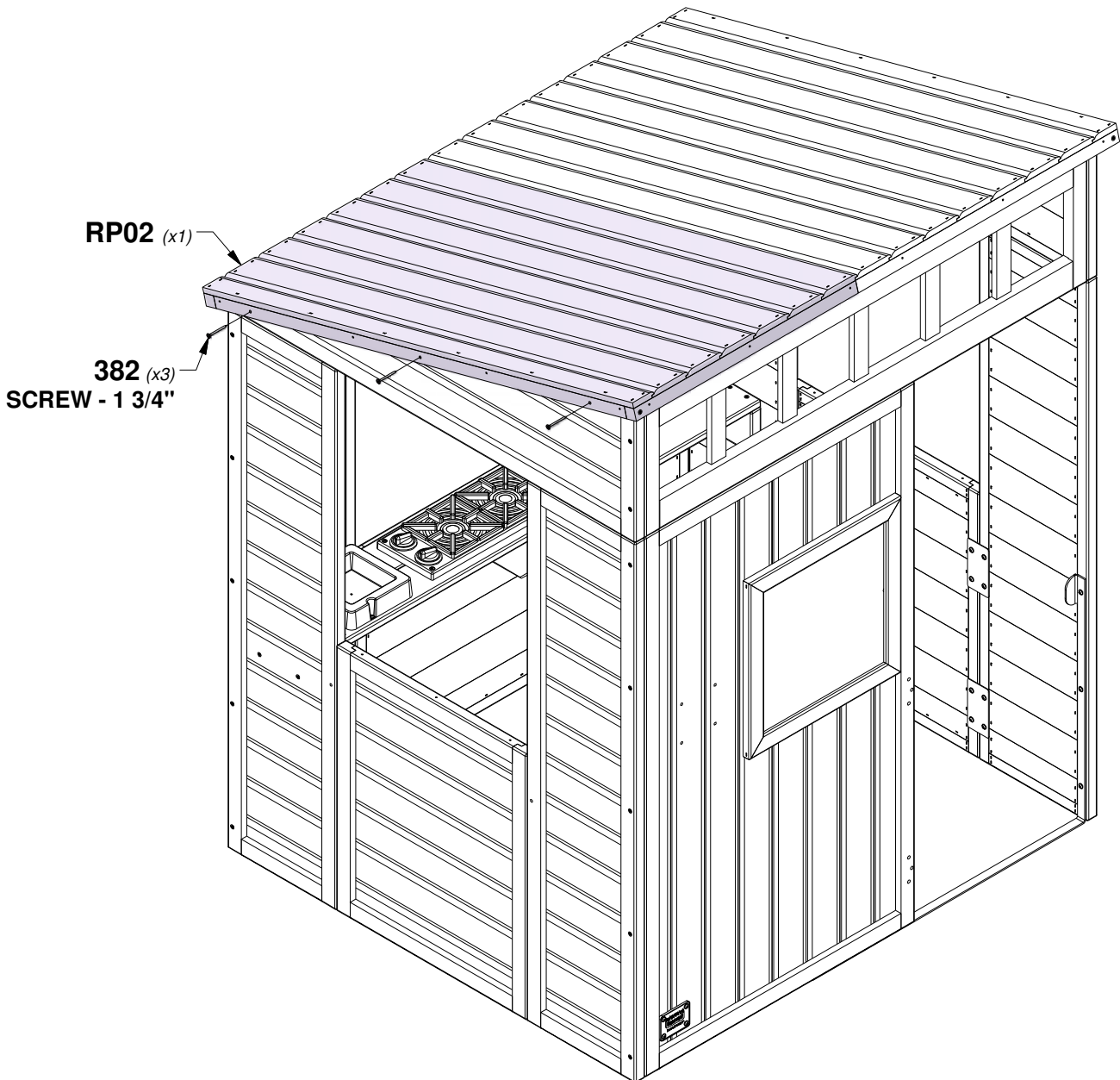

STEP 22 - PLAYHOUSE ASSEMBLY

QTY	PART NUMBER	DESCRIPTION
6	H100387	SCREW PFH 8x1-1/4 BLK

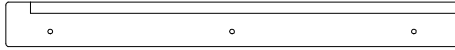

F03 ROOF TRIM - W4L19820
(x1) 1"x1 7/8"x18 7/8" (26x47x479)

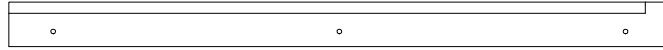

F02 ROOF TRIM - W4L19316
(x1) 1"x1 7/8"x27 1/2" (26x47x700)

TIP:
ALIGN PILOT HOLES

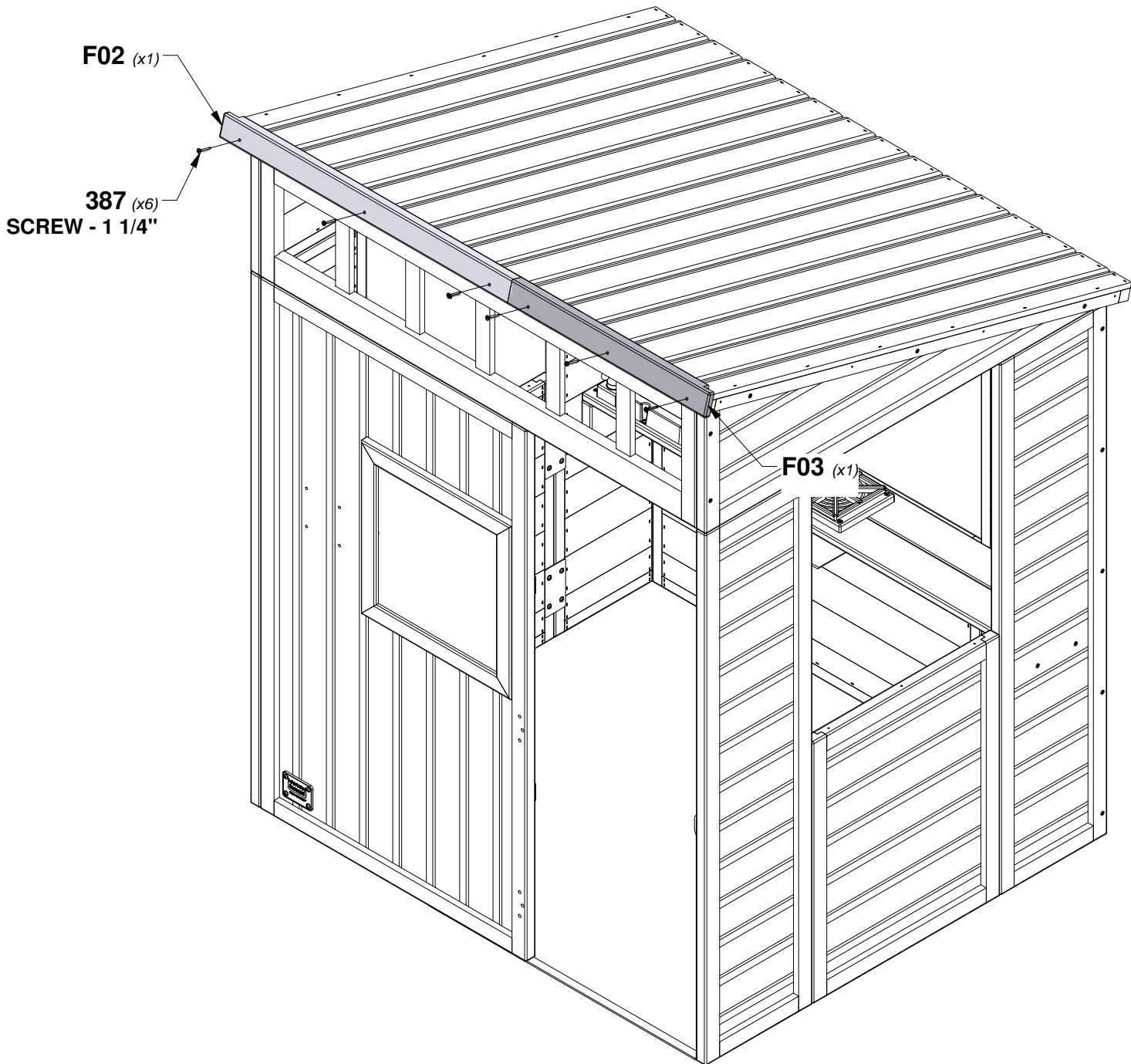

F02 (x1)

387 (x6)
SCREW - 1 1/4"

F03 (x1)

STEP 23 - PLAYHOUSE ASSEMBLY

QTY	PART NUMBER	DESCRIPTION
4	H100387	SCREW PFH 8x1-1/4 BLK



F01 ROOF TRIM - W4L19315
(x1) 1"x1 7/8"x41 7/8" (26x47x1064)

TIP:
ALIGN PILOT HOLES

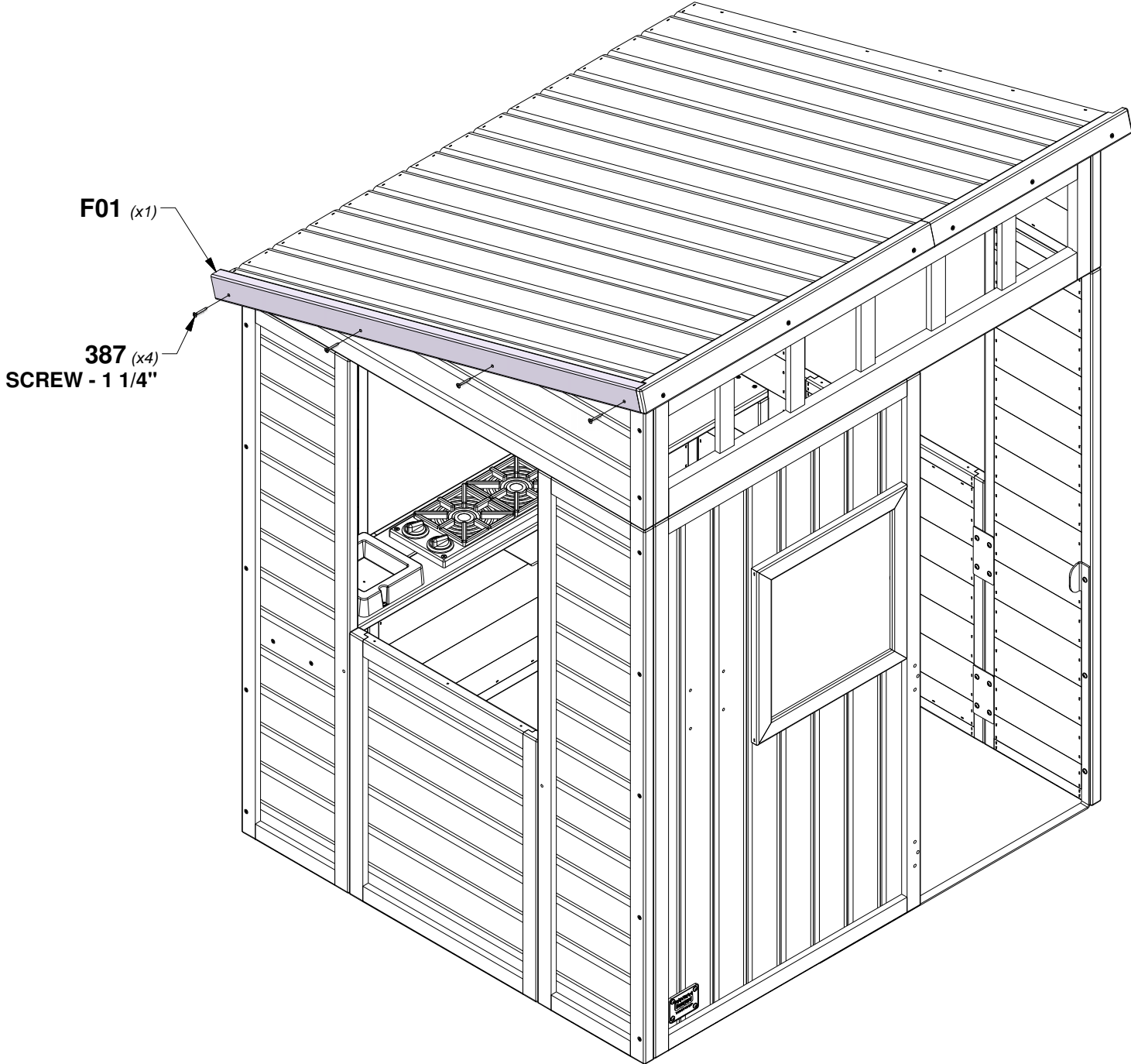

F01 (x1)

387 (x4)
SCREW - 1 1/4"

STEP 24 - PLAYHOUSE ASSEMBLY

QTY	PART NUMBER	DESCRIPTION
4	H100387	SCREW PFH 8x1-1/4 BLK



F01 ROOF TRIM - W4L19315
(x1) 1"x1 7/8"x41 7/8" (26x47x1064)

TIP:
ALIGN PILOT HOLES

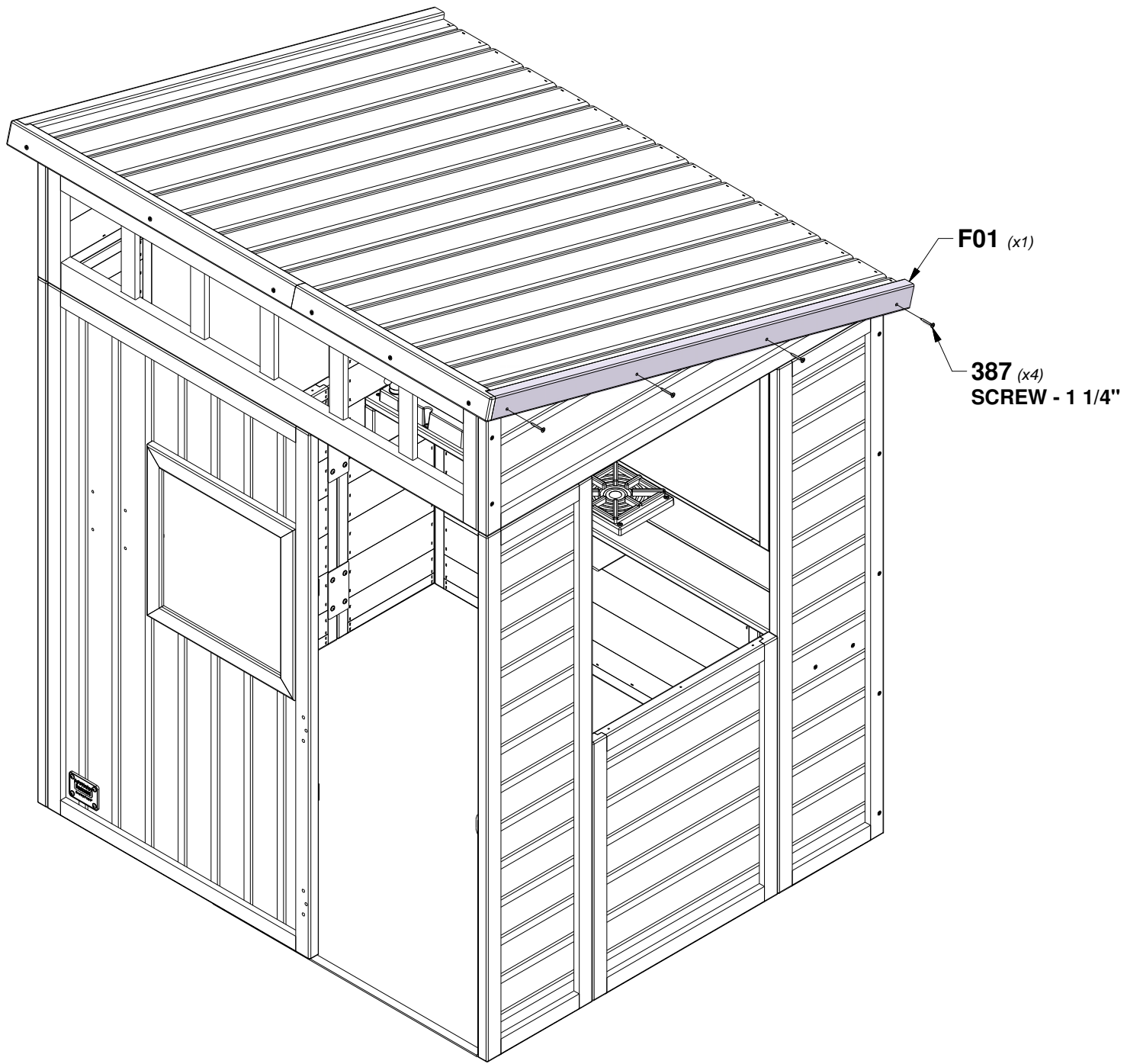

STEP 25 - PLAYHOUSE ASSEMBLY

QTY	PART NUMBER	DESCRIPTION
7	H100387	SCREW PFH 8x1-1/4 BLK

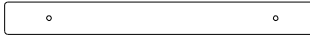

N04 ROOF TRIM - W4L19819
(x1) 5/8"x1 3/8"x12 3/4" (16x34x324)

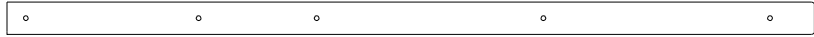

N03 ROOF TRIM - W4L19317
(x1) 5/8"x1 3/8"x33 5/8" (16x34x855)

TIP:
ALIGN PILOT HOLES

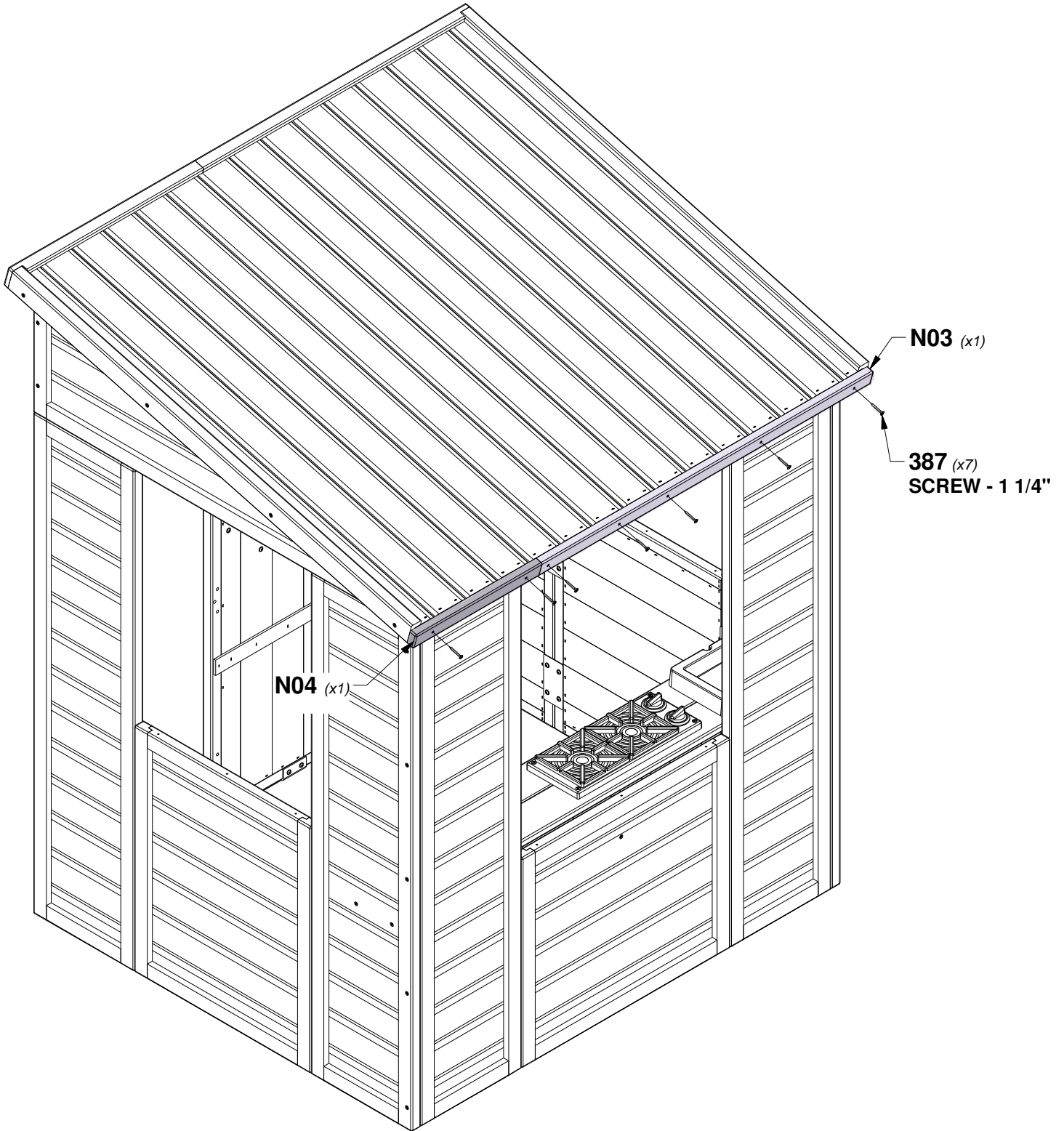

STEP 26 - PLAYHOUSE ASSEMBLY

QTY	PART NUMBER	DESCRIPTION
12	H100804	T-NUT 8/32
12	H100807	SCREW POH-MS 8/32x1 BLK

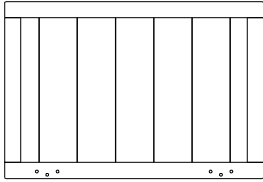

DP01 DOOR PANEL - W2A04148
(x1) 1"x10 1/4"x43 7/8" (24x374x548)

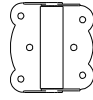

A4M00624 HINGE (DOOR, SPRING LOADED)
(x1)

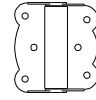

A4M00994 HINGE (DOOR, NON-SPRING LOADED)
(x1)

TIP:
INSTALL T-NUTS IN WOOD FIRST

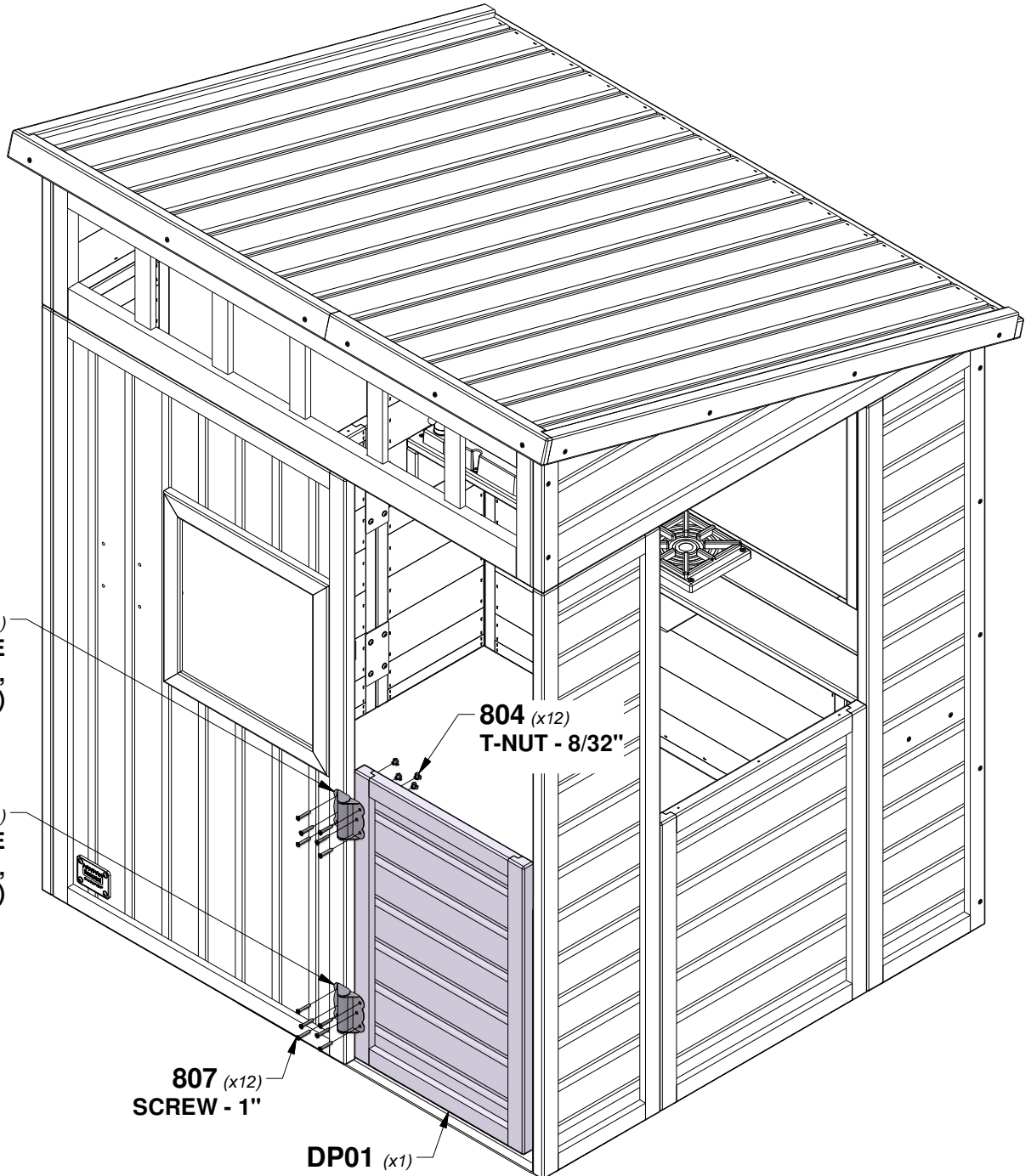

624 (x1) HINGE (DOOR, SPRING LOADED)

994 (x1) HINGE (DOOR, NON-SPRING LOADED)

804 (x12) T-NUT - 8/32"

807 (x12) SCREW - 1"

DP01 (x1)

STEP 27 - PLAYHOUSE ASSEMBLY

QTY	PART NUMBER	DESCRIPTION
4	H100797	SCREW PWH 8x1 BLK

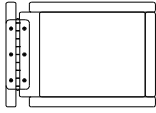

MB01 MAILBOX - W2A04223
(x1) 3 3/8"x6 9/16"x8 3/4" (86x166x222)

TIP:
ALIGN PILOT HOLES

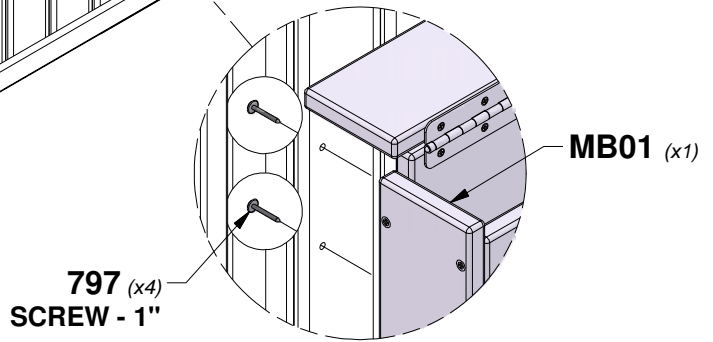
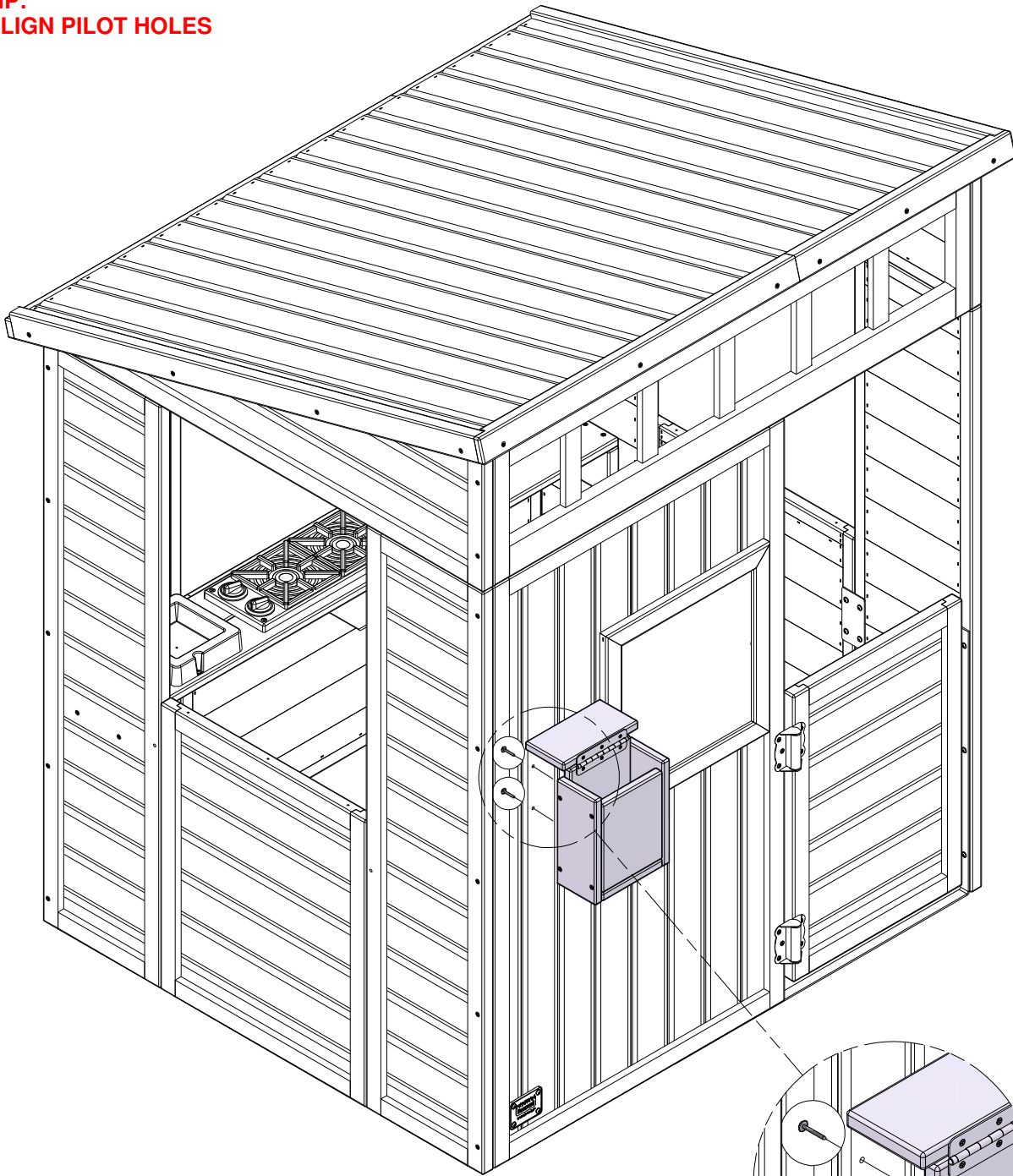

STEP 28 - PLAYHOUSE ASSEMBLY

QTY	PART NUMBER	DESCRIPTION
2	H100391	SCREW PFH 8x2 BLK

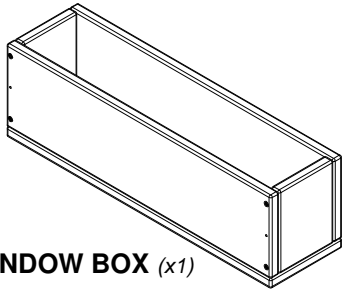

WINDOW BOX (x1)

TIP:
ALIGN PILOT HOLES

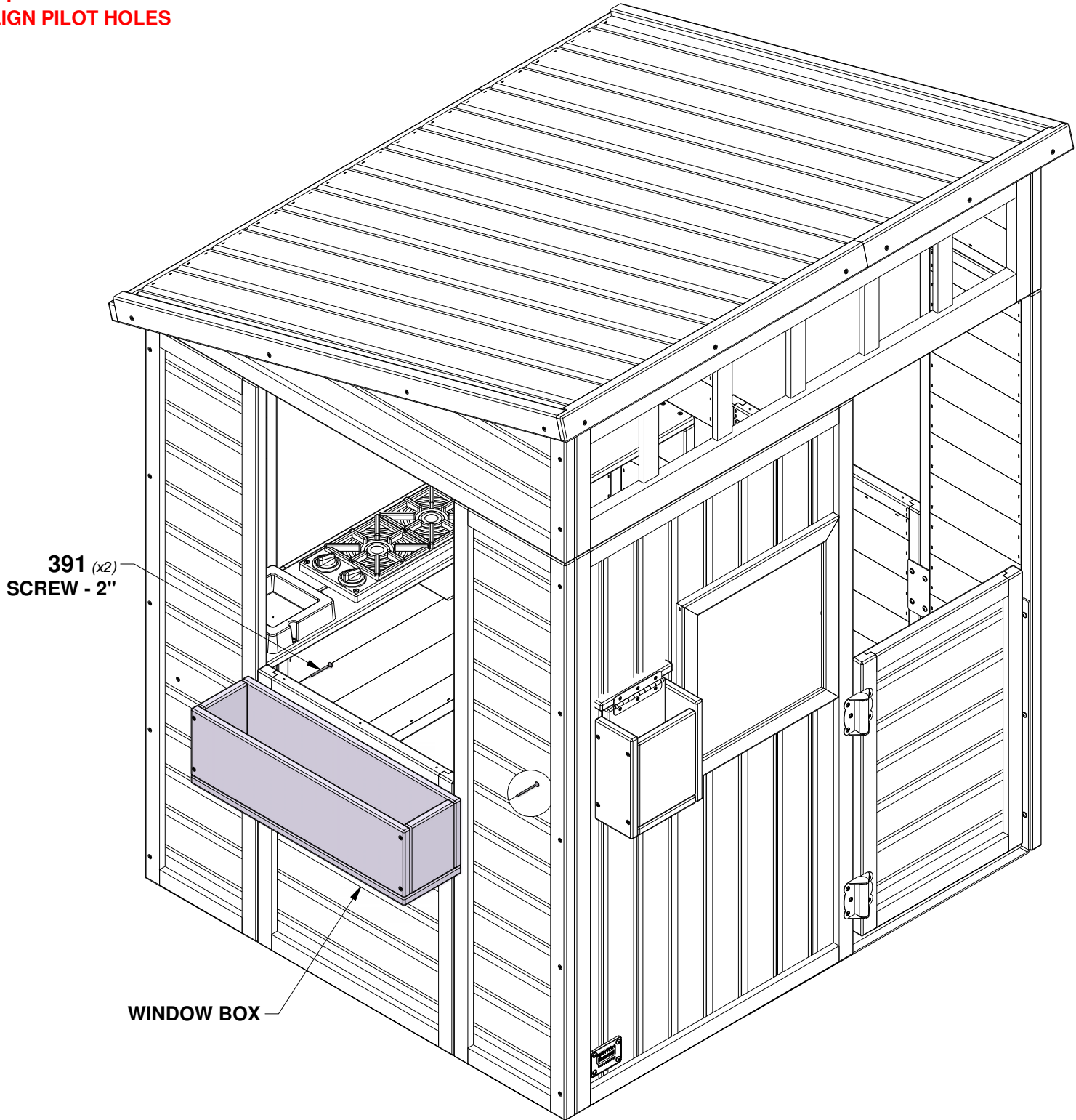

WINDOW BOX

STEP 29 - PLAYHOUSE ASSEMBLY

QTY	PART NUMBER	DESCRIPTION
3	H100200	SCREW PFH 8x1-1/2 BLK

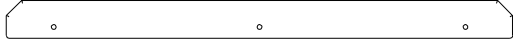

N02 WINDOW BOARD - W4L19310
(x1) 5/8"x1 5/8"x21 1/8" (16x40x536)

TIP:
ALIGN PILOT HOLES

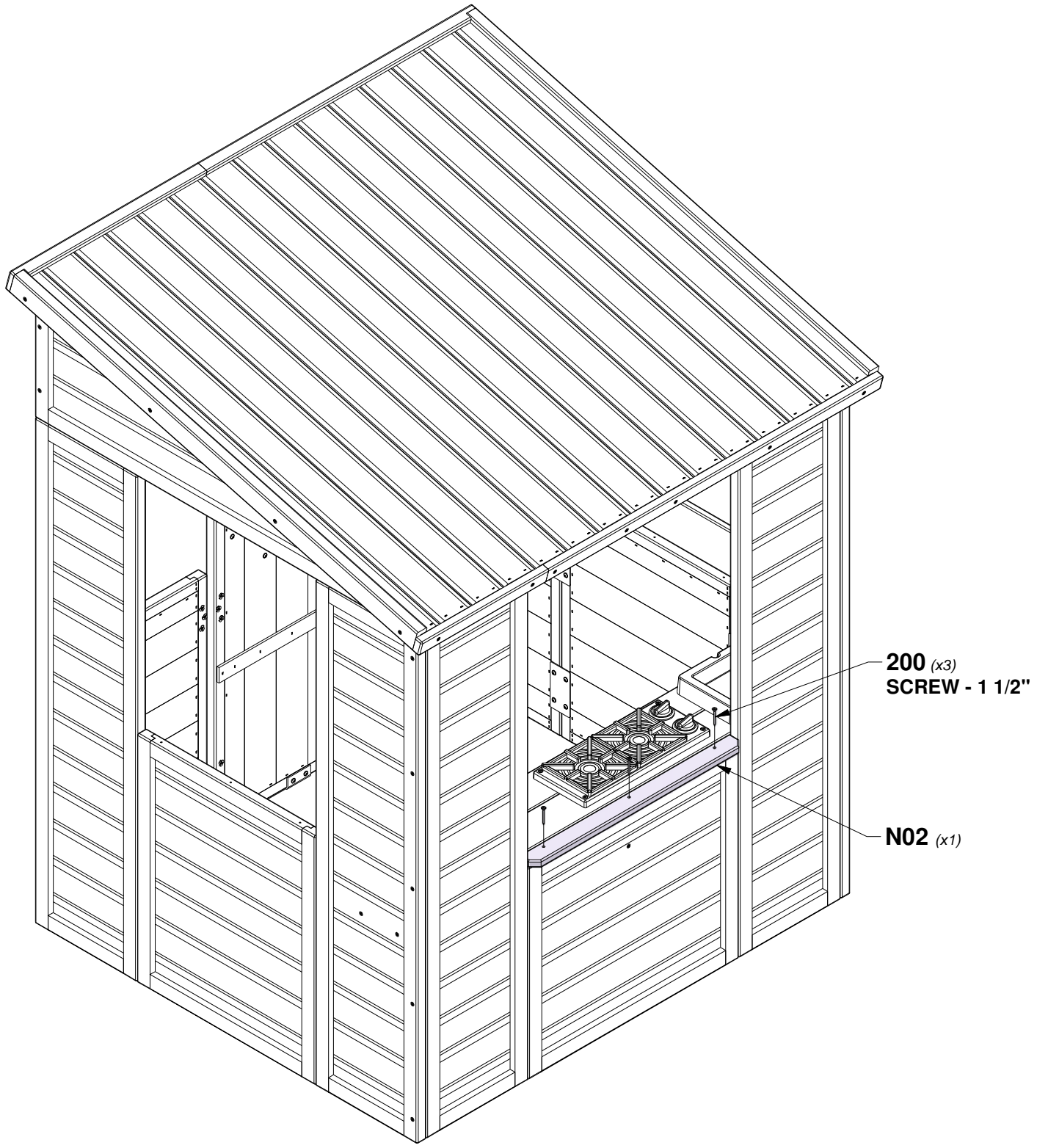

STEP 30 - PLAYHOUSE ASSEMBLY

QTY	PART NUMBER	DESCRIPTION
3	H100200	SCREW PFH 8x1-1/2 BLK



N01 WINDOW BOARD - W4L19309
(x1) 5/8"x1 5/8"x17 7/8" (16x40x454)

TIP:
ALIGN PILOT HOLES

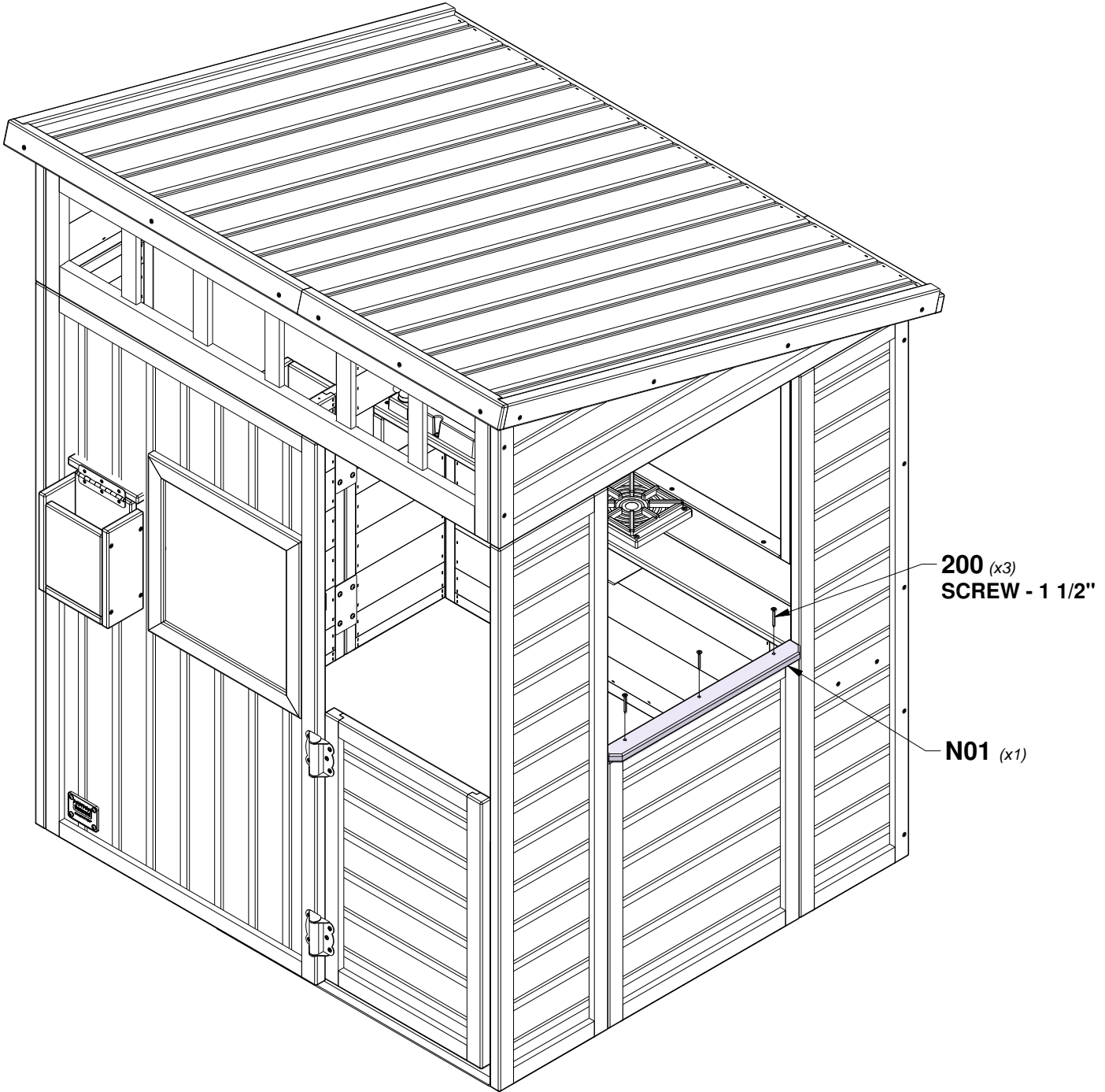

STEP 31 - PLAYHOUSE ASSEMBLY

QTY	PART NUMBER	DESCRIPTION
3	H100200	SCREW PFH 8x1-1/2 BLK

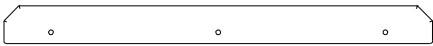

N01 WINDOW BOARD - W4L19309
(x1) 5/8"x1 5/8"x17 7/8" (16x40x454)

TIP:
ALIGN PILOT HOLES

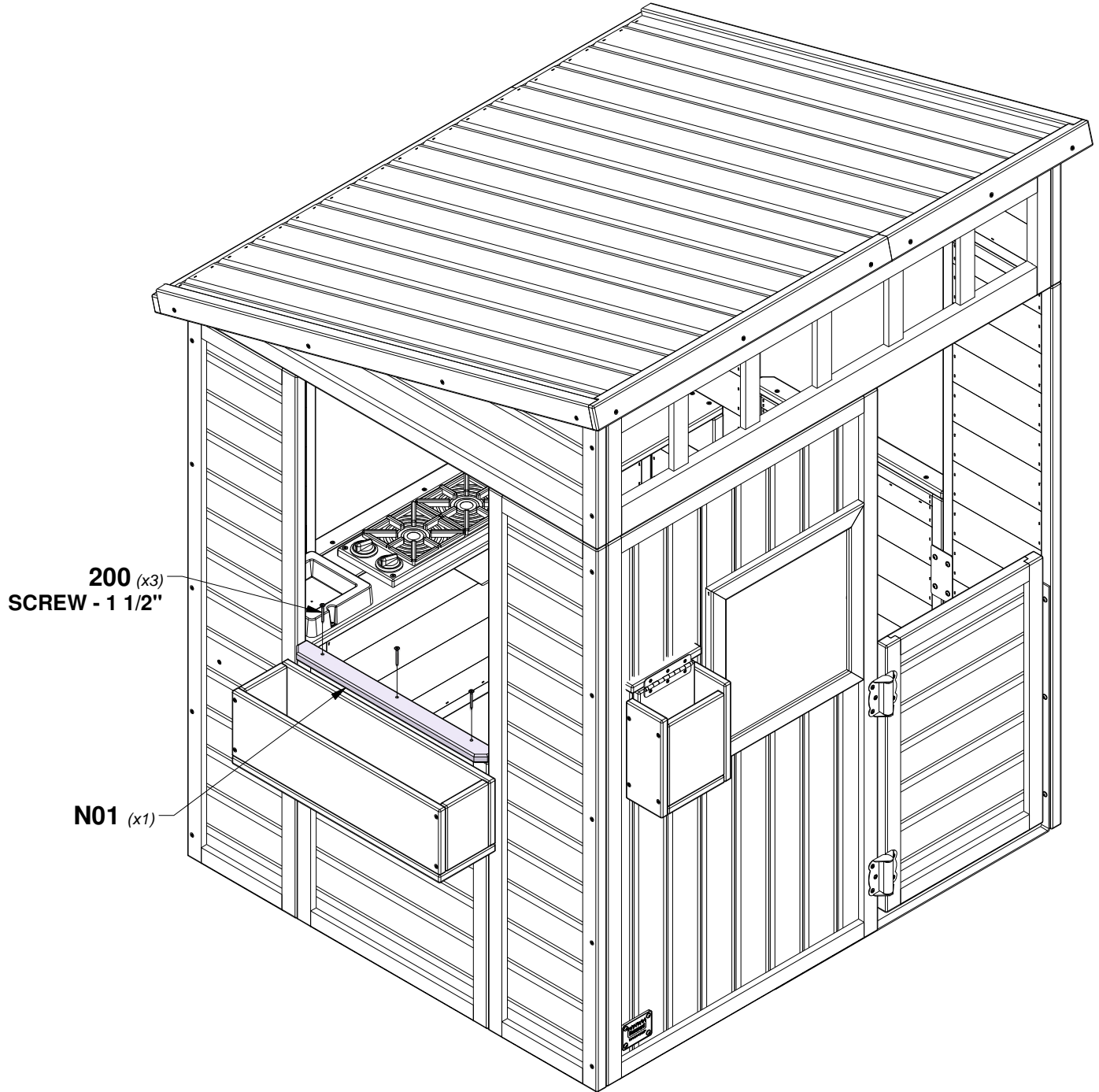

STEP 32 - PLAYHOUSE ASSEMBLY

QTY	PART NUMBER	DESCRIPTION
4	H100192	NUT BARREL WH 5/16x7/8 BLK
4	H100199	WASHER LOCK EXT 12x19 BLK
4	H100396	BOLT WH 5/16x1/2 BLK

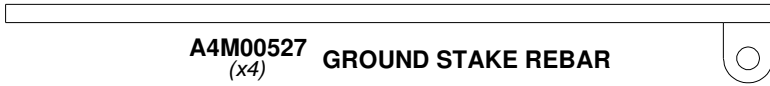

NOTE:
TAP IN GROUND STAKES AT AN APPROXIMATE 45° ANGLE AT LOCATIONS SHOWN. USING GROUND STAKE AS A GUIDE, DRILL 3/8" [10mm] DIA HOLES FOR HARDWARE.

TOP VIEW

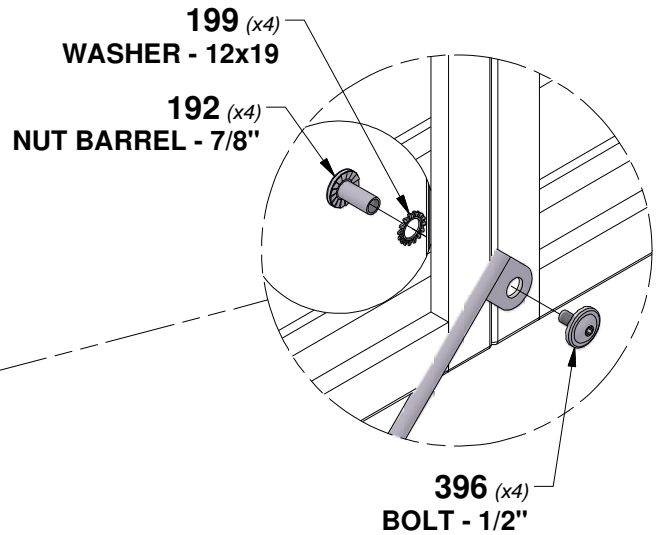
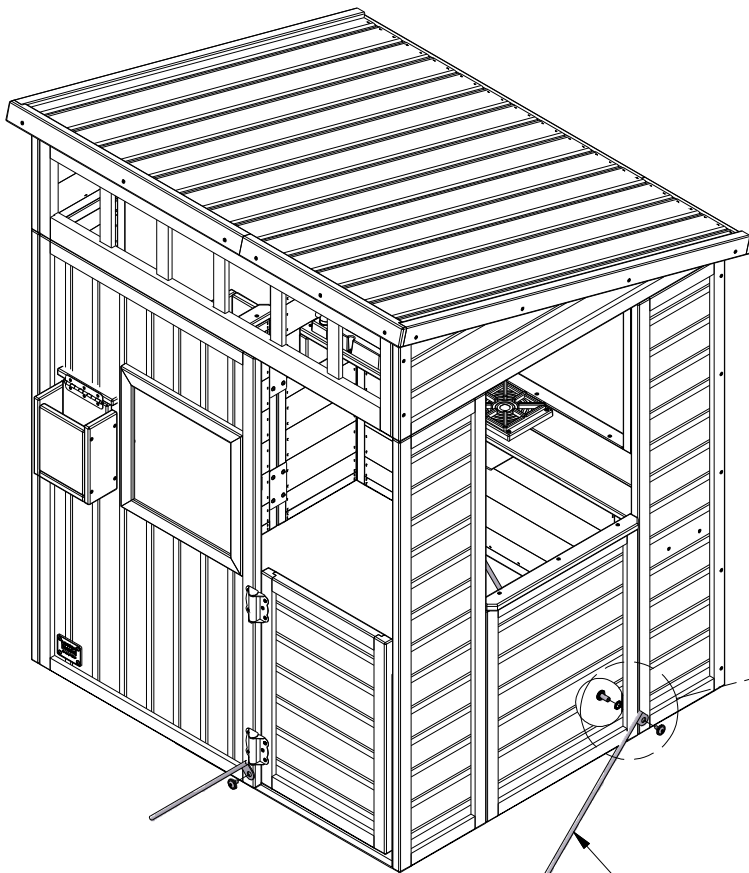
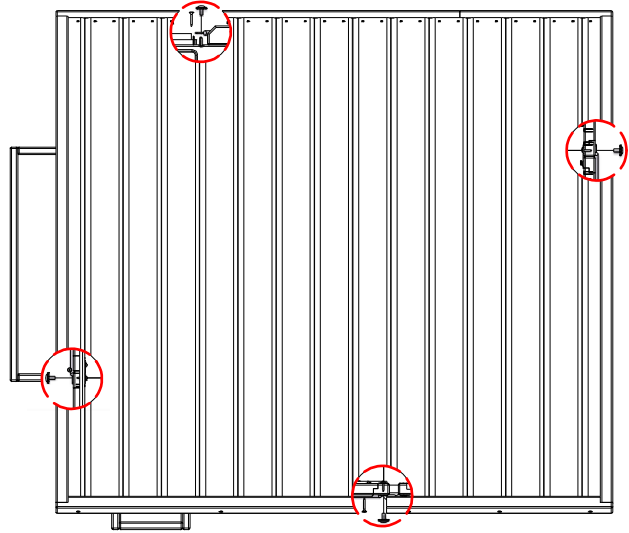

527 (x4)
GROUND STAKE REBAR